

TOURNA®



UNIQUE

SPORTS PRODUCTS

2018-2019



Pro Gel™

- Absorbs shock
- Cushions

Provides max shock absorption. Pro Gel has a tread pattern for excellent traction and racquet control. It provides max cushioning and absorbs shock which can travel to your elbow. It will minimally enlarge the grip which is desirable to prevent tennis elbow.

Thickness: 2 mm

GCS-BK



Tread pattern

Absorbing Gel



MEGA WRAP™

Make your grip great again!

1.5 mm Replacement Grip

- Exclusive tacky PU coating clings to your hands
- Prevents twisting and slipping for max control
- Very durable
- Reduces sting and vibration
- Traction craters create secure grip and tacky feel
- Perforations absorb sweat

Remove old grip and wrap over bare racquet handle

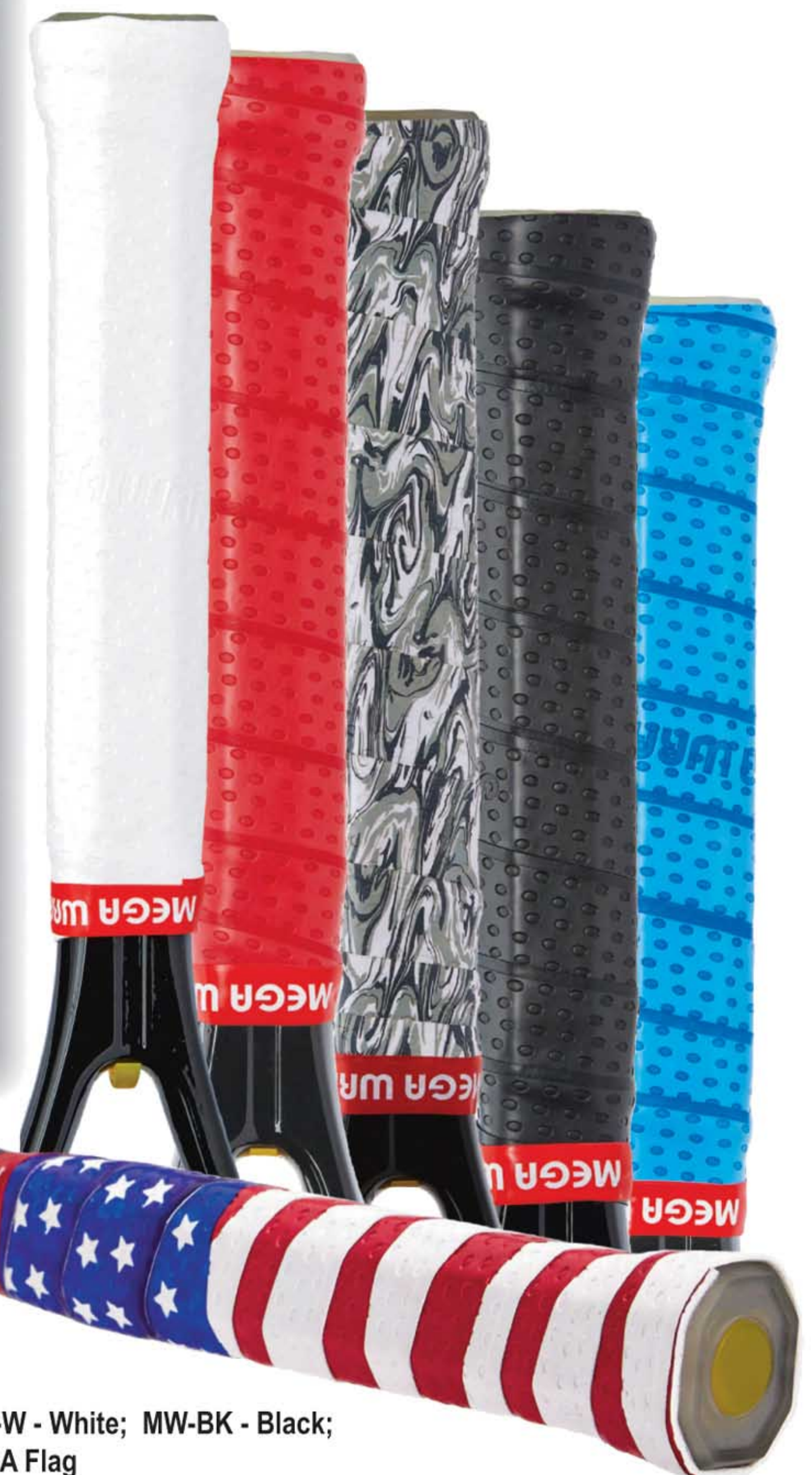
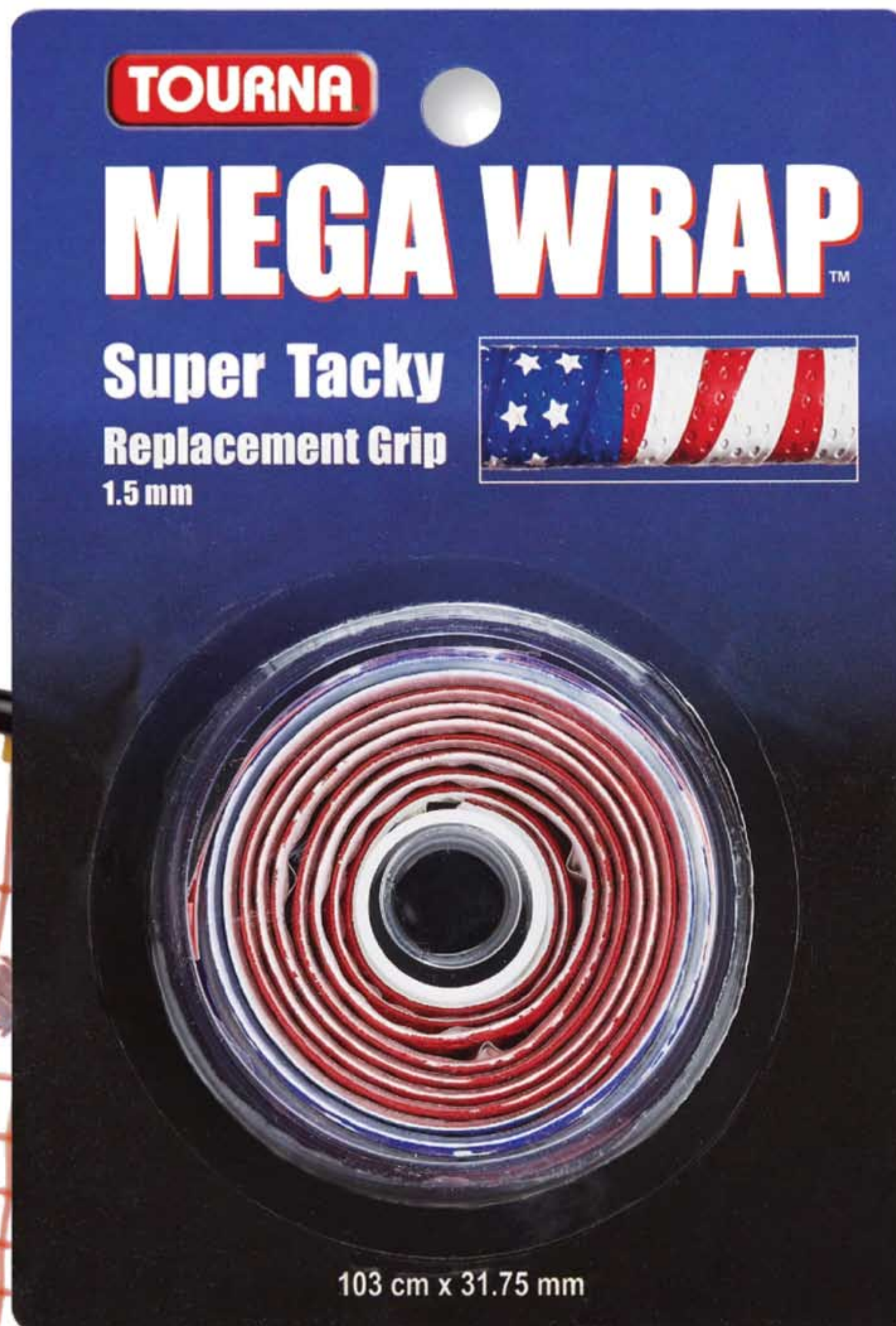

MW-R - Red; MW-B - Blue; MW-W - White; MW-BK - Black; MW-CAM - Cameo; MW-US - USA Flag

Our replacement grips are made with adhesive backing for quick installation. Edges are beveled for perfect fit and quick easy installation.



Pete Sampras



Pete Sampras TOUR GRIP®

This grip is perforated for superior absorption. The edges are beveled for perfect, seamless fit when wrapped over the handle. This is what Pete Sampras uses as his foundation grip under his Tourna Grip.

CTGS-BK Black

Top Seller!



PRO TOUR GRIP® - 1.5 mm slim

The thin polymer material is made to let you feel the bevels of the grip with a tacky feel. Pro Tour Grip is perforated over the entire surface to absorb moisture and provide a skin tight wrap around the handle.

At 1.5 mm, it is slightly thinner than typical cushion grip and is made for maximum feel and precision on the court.

PRO-BK Black
PRO-W White

PRO THIN GRIP - 1.25 mm - slimmest



The thinnest replacement grip on the market

REDUCES GRIP BY ONE SIZE

Very thin, (1.25 mm thick) polymer material is designed to let you feel the bevels of your grip to a maximum. Contains minimal cushioning for a true feel. Pro Thin Grip is perforated over the entire surface to provide absorption and a tight fit around the handle.

PRO-T-BK Black

LEATHER GRIP

Genuine Leather Grip

Made from premium cowhide. It is firm and durable. Comes with adhesive backing for quick installation. We bevel the edges for perfect fit and easy installation.

Used by top players.

TLG-T Tan



Classic TOUR GRIP®

No perforations. Tacky and firm for maximum control. Same quality as the perforated version

CTG-BK-N ; CTG-W-N



TOURNA

SOFT TAC™ OVERGRIP

Neon Colors

Grabs you back • Absorbent • Feels so good



Soft Tack comes in two brilliant neon colors. Overgrip is soft to touch yet has pleasant tack that grabs you back. It will prevent slippage and will deliver a firm dependable grip.

- # ST-NG, Neon Green (3 grip pack)
- # STT-NY, Neon Yellow (3 grip pack)



3 grips on a roll with finishing tape to secure the grip to racquet

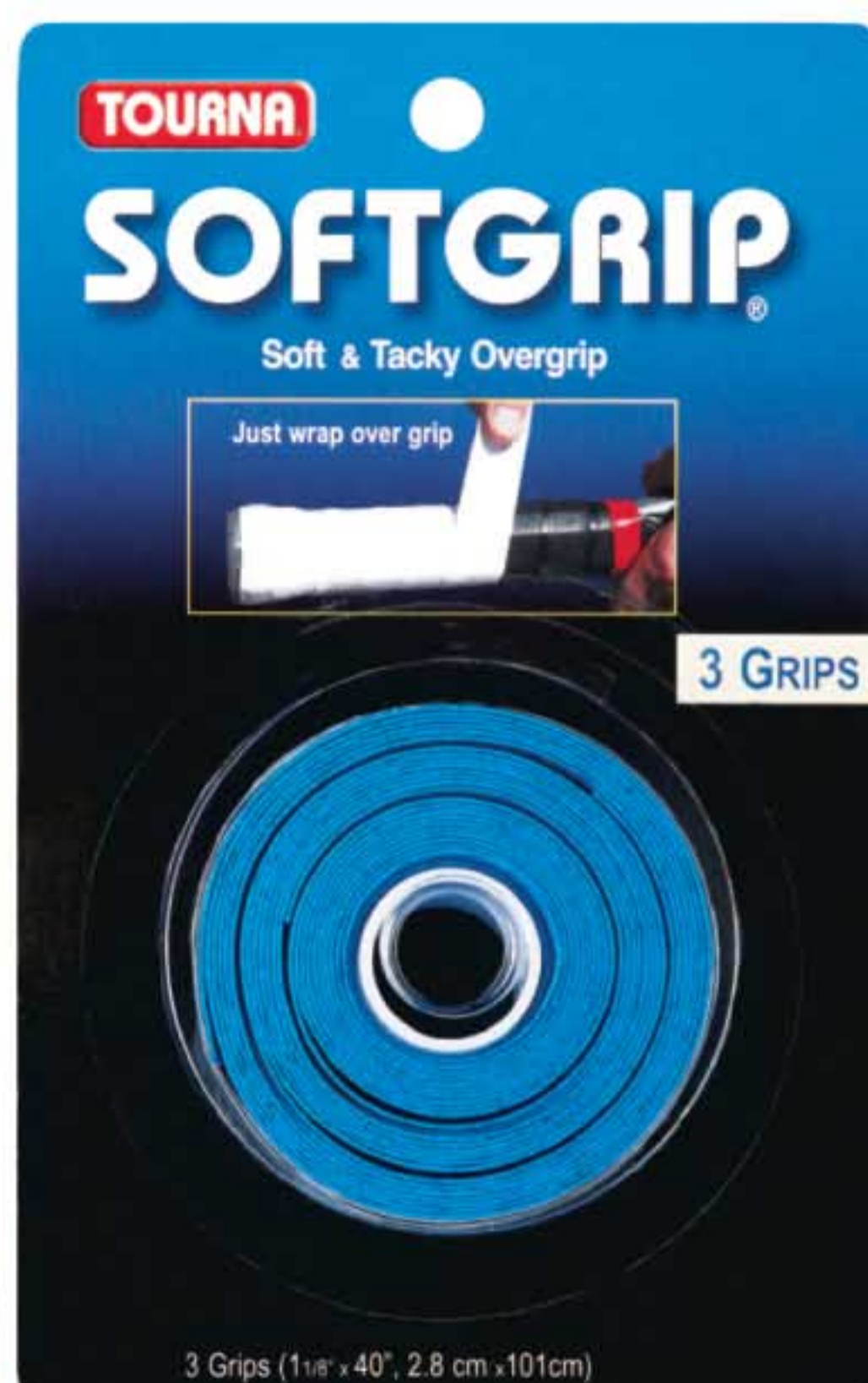
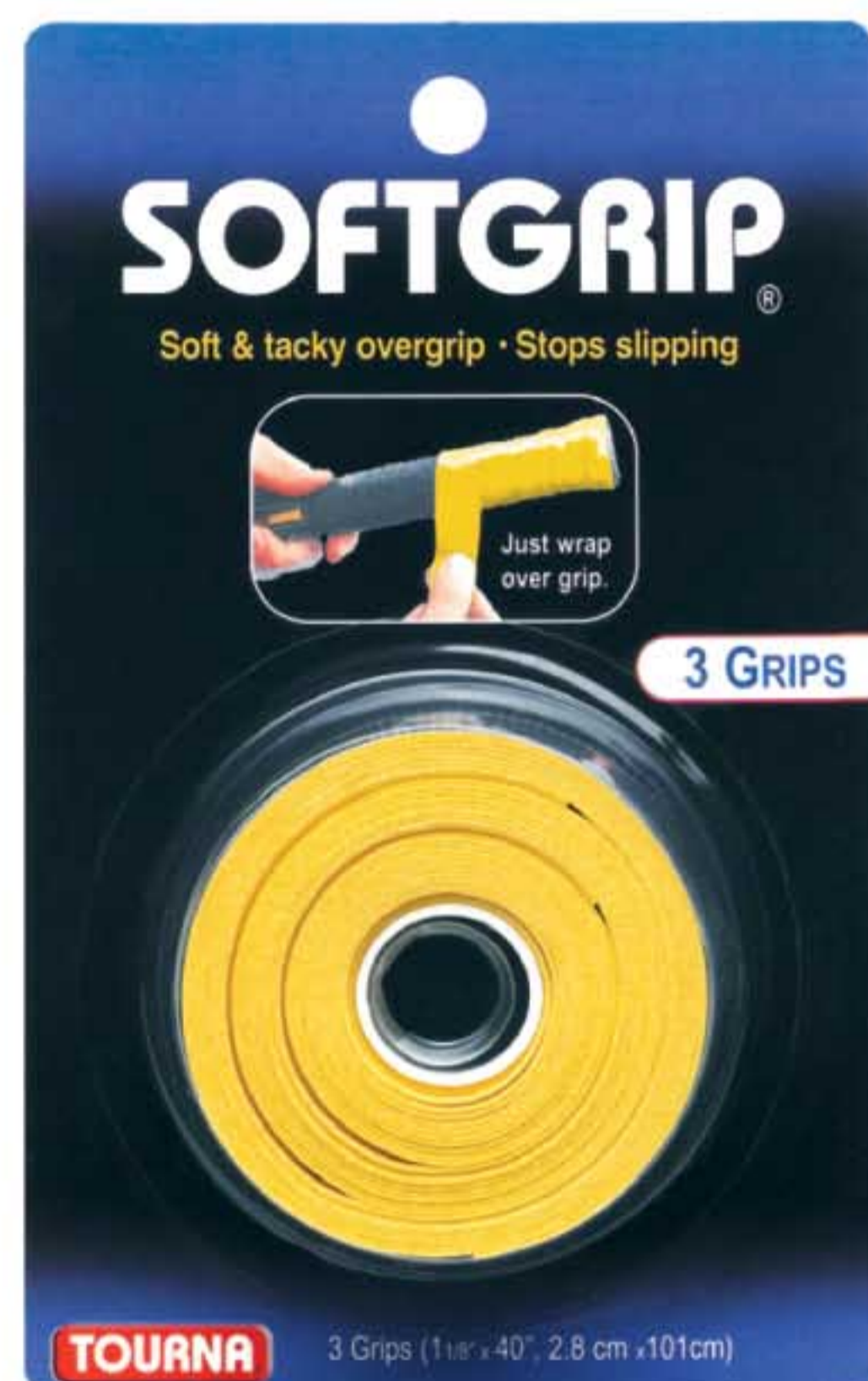

SOFTGRIP® Overgrip

Known for its soft, luxurious tacky feel since 1984. Soft feel, previous national advertising with Vic Braden (Tennis Hall of Fame teaching pro) and low price have made Soft Grip a favorite with older recreational tennis players.

- # STG-1 White, Yellow, Black, Blue (3 grip pack)



3 grips on a roll with finishing tape to secure the grip to racquet

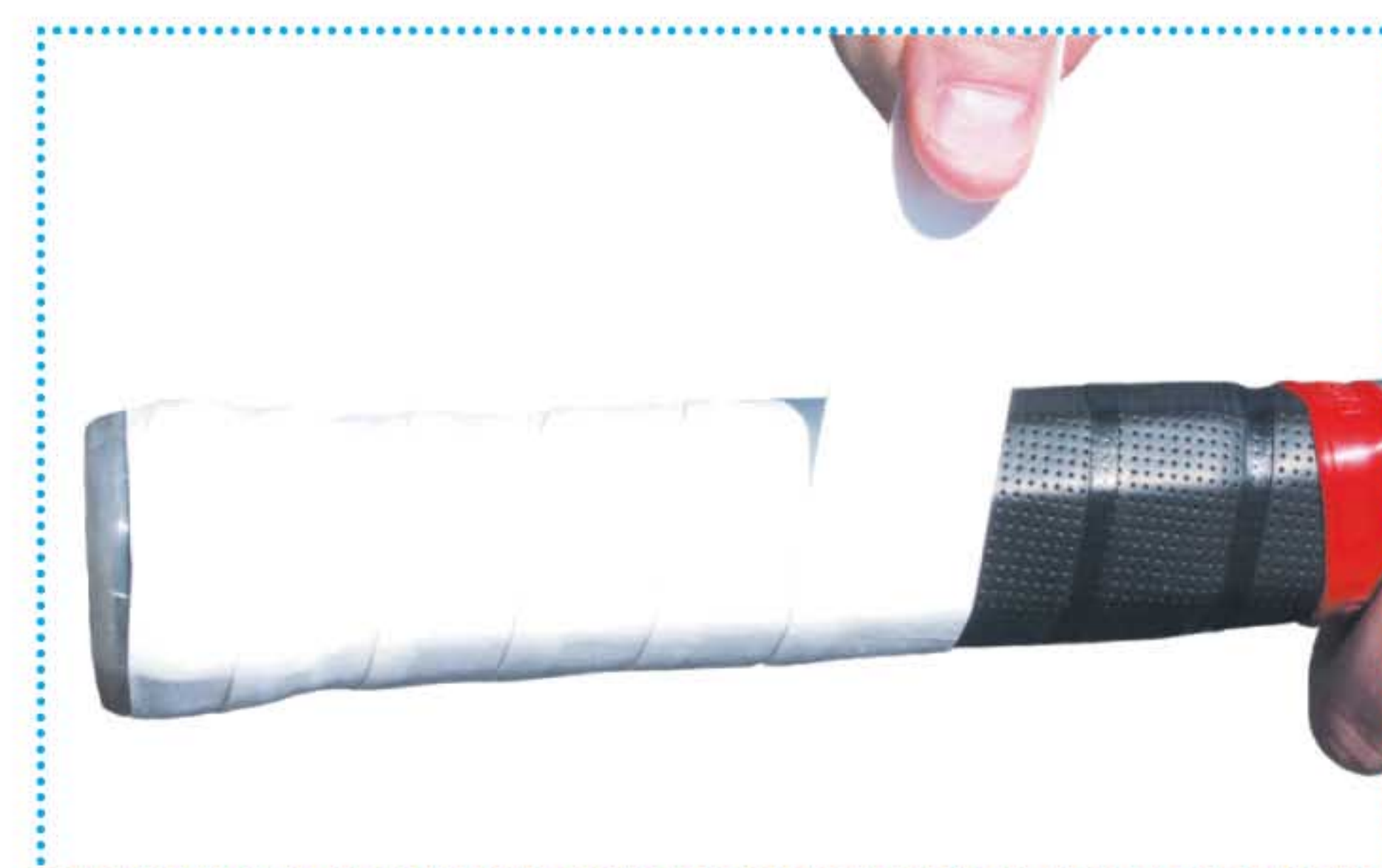



ROZ-3B

Top Seller!
Twist open-close



ROZ-3



ROZ-1



ROSIN GRIP

Now in a shaker top package. Simply twist the top and shake on hands.

- # ROZ-3B Blister card (6/cs)
- # ROZ-3 Bulk (6/cs)

In traditional bag package. Just slap against hands or grip to dispense rosin. Excellent in very humid conditions. Packaged in reusable, zip lock pouch. Endorsed by Pete Sampras.

ROZ-1 (Bag)

Pete Sampras



Dab on few drops



GRIP Rx

Instant Grip enhancer. A quick, effective solution to dry sweaty hands. Just dab on and rub hands or gloves together. Allow to dry to a light powder.

Non-toxic, safe to use. Patented formula.

GRX-2

*** Foil sealed bottle to ensure freshness***



TAC RAG

Tacky bees wax is saturated in the Tac Rag. It delivers gripping power with no mess and without a lingering sticky feel. It dissipates quickly, is safe, non toxic and will not stain. When the Rag turns gray throw it away.

Lasts about 4 to 6 weeks of average use. Packaged in zip lock bag for storage.

TRAG-WXL White, 9" x 18"



Just rub on

Handy carry vial



PRO STICK

Just rub on your grip. Non-toxic, safe and very tacky. Lasts indefinitely. Stores in a handy vial which fits in pocket. Pro Stick was the first product of UniqueSports in 1972.

PSC-3

GRIP TAPE®

For a rough, tacky, sticky feel. It is made of very thin, surgical tackified gauze. Just wrap over grip, it sticks to itself. One can use it to build up a racquet grip size - one layer will build up a handle by 1/16".

Each roll is 360" long
Colors: Green, Royal Blue, Black, White



Just wrap on



DRI HOLD™

This pull over knitted overgrip is made with stretch cotton fibers. Cotton absorbs great. DRI HOLD is the most economical overgrip available. You can wash and reuse it and reuse it. Available in white and blue colors.

DH-1 White
DH-B Blue

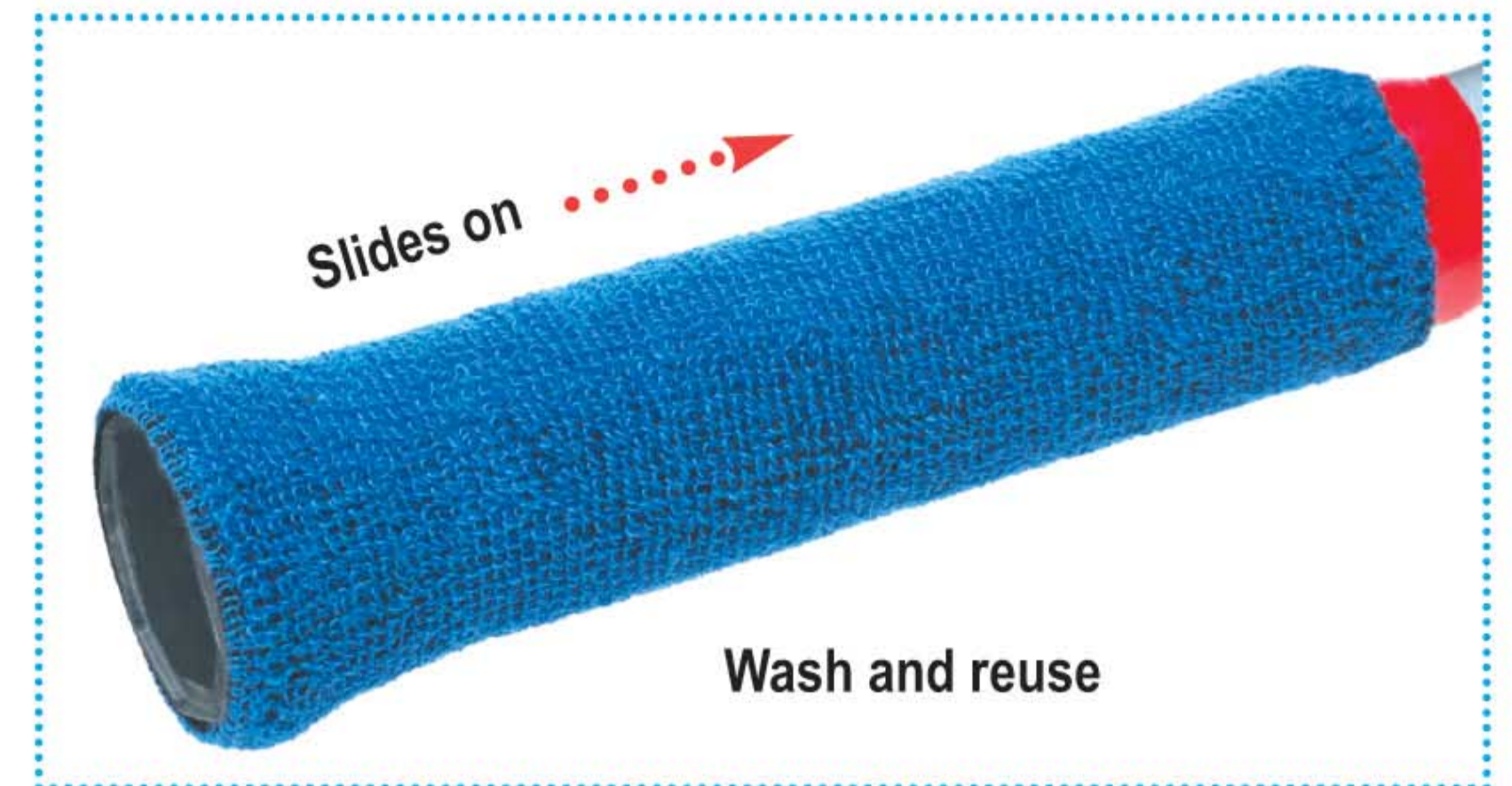

Tennis Gloves

Quality gloves are made of soft, extra thin calf skin leather with plush terry on backside. Gloves deliver excellent control during cold weather.

The half-finger glove keeps the hand warm while allowing fingers to feel the grip.

Sizes: S, M, L, XL - Men's and Ladies sizes, Right or Left hand

Consult price sheet for stock numbers.

TGF Full finger
TGH Half finger



Half Finger



Full Finger



HOT GLOVE® Mitt

Slip your hand into the Mitt and insert the racquet handle through narrow opening at top of Mitt.

Mitt does not hinder hand movement. Makes playing in cold tolerable. Ends blowing on hand to bring warmth. 100% breathable fleece.

One size fits all.

RHG-1 Black

A must have item in winter



Durable

Lightweight

Snug fit



GRIP BANDS

Made of stretch silicone material to secure overgrips or replacement grips.

GB-2



GRIP Finishing Tape

Used to secure grips to racquet handle. Available in Black and Red.

FT-BK Black
FT-R Red
1/2" x 60' (20 meters)



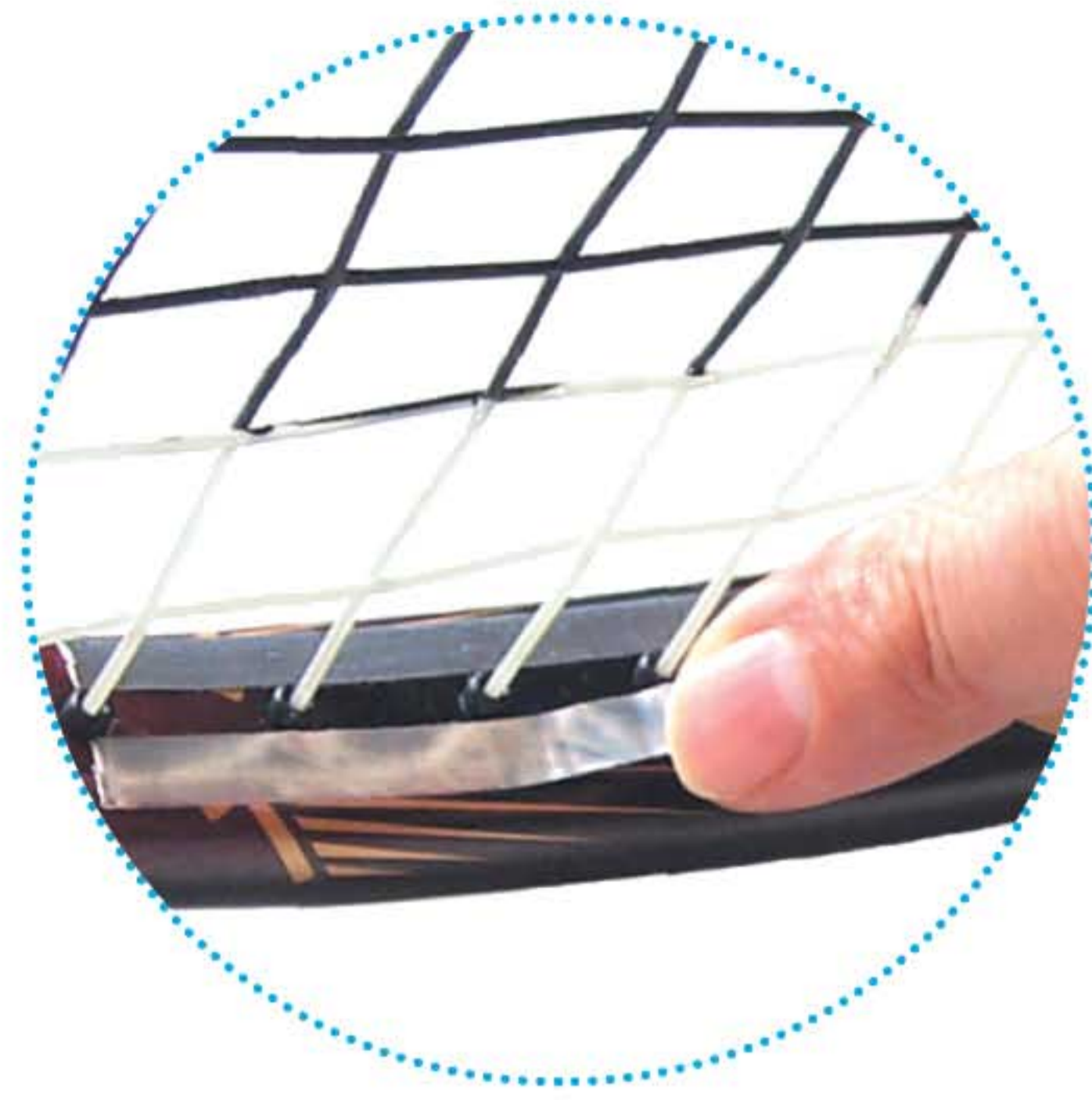
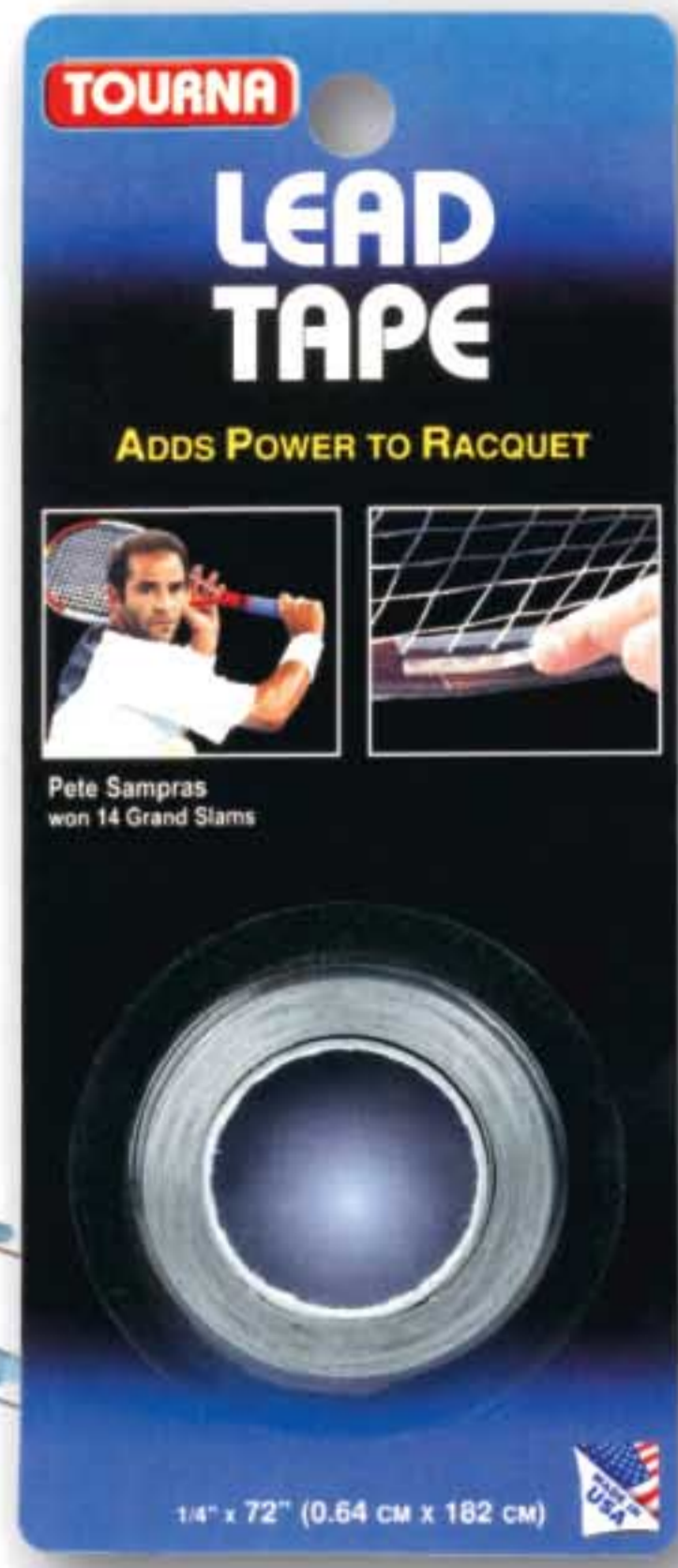

Sticks to Racquet Frame

LEAD TAPE

Adds weight to your racquet and delivers more power. Adhesive backed so it attaches easily to racquet frame. Just cut and press. Used and endorsed by Pete Sampras.

LD-36 (1/4" x 72") on card
(Strip cut to 4" in length adds 1 gram)

REELS:

LD-107 - 1/4" x 36 yards
LD-108 - 1/2" x 36 yards



Sticks to Racquet Frame

Lead POWER STRIPS

Power lead strips are pre-cut so you simply attach to racquet frame as shown in photo.

Each strip adds 3.62 grams of weight. Used and endorsed by Pete Sampras.

LD-6 Six strips per package

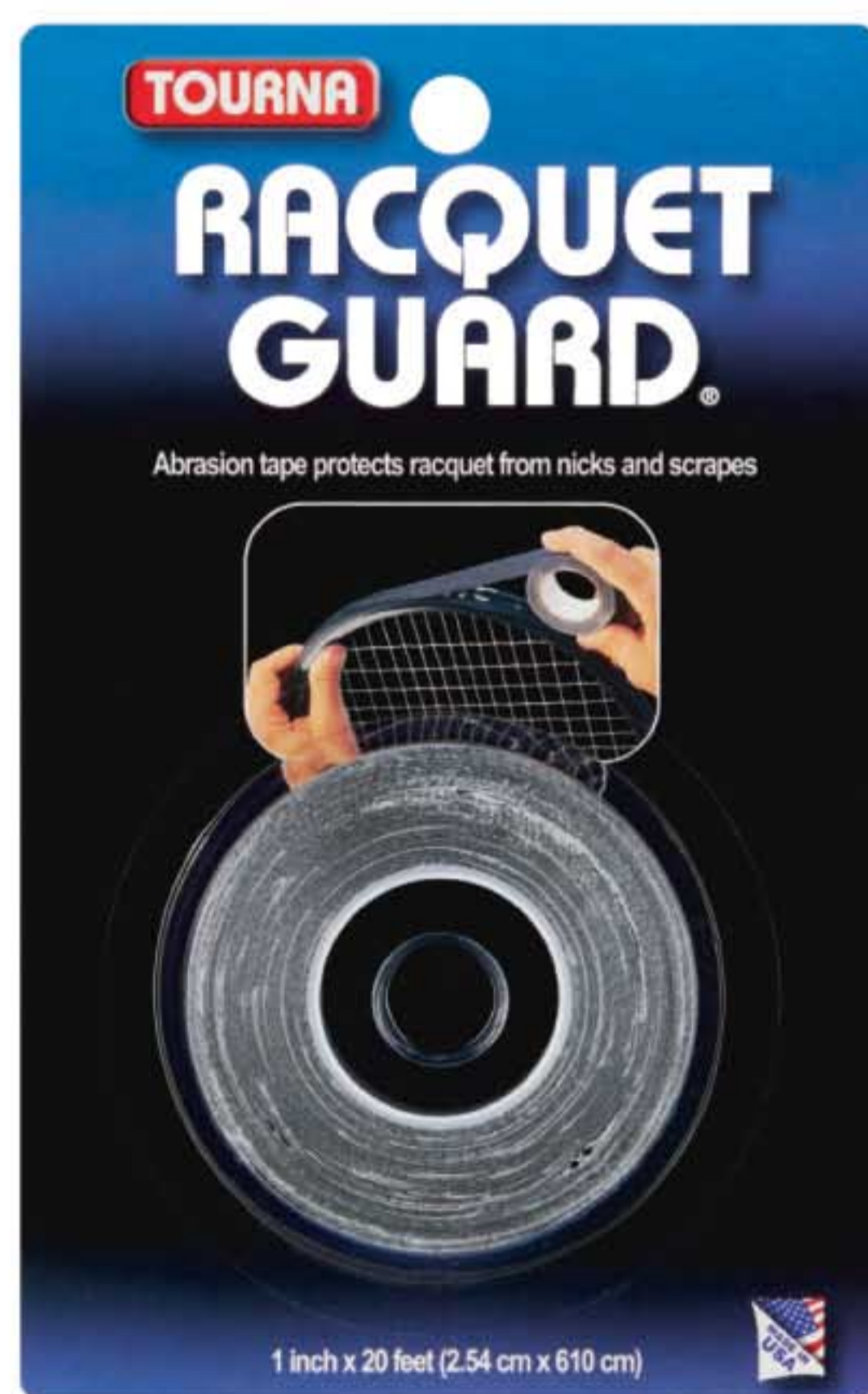

Just tape over racquet frame

RACQUET GUARD® Tape

Guard the frame from ground nicks and scrapes. It stays on. Minimal weight is added to racquet. Very tough, durable protection tape. You get 20 feet of tape.

RGT-BK - Black - 1" x 20 ft



POWER CAP®

Allows you to grasp the racquet with butt end in the palm. This is vital to impart extra speed on ball without the end-cap digging into your hand.

Patent # 5,485,996

RPC-1

HIPSTER™ Ball Band

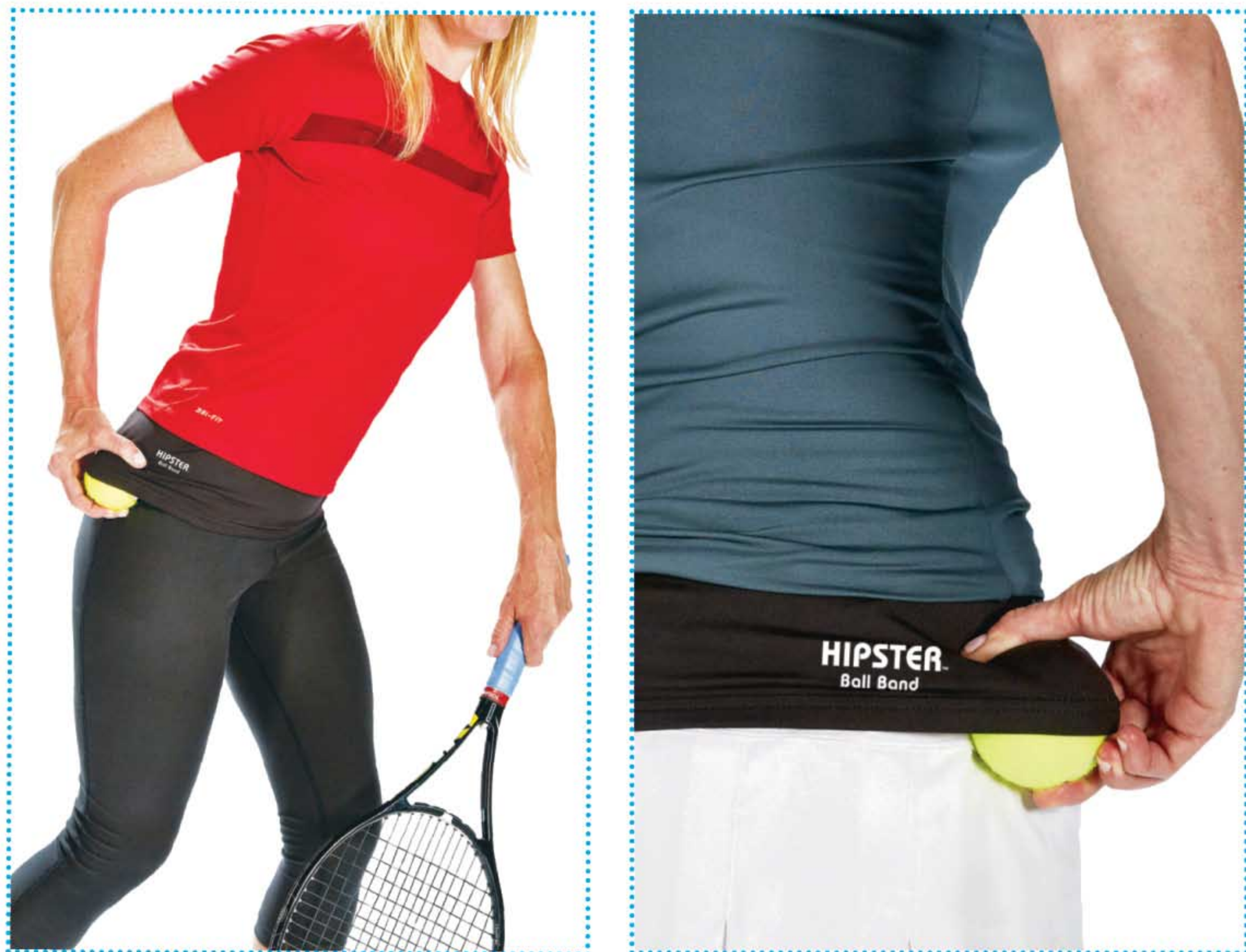

No pockets! No problem!

Holds extra balls. Simply put Hipster around your hips. Fits comfortably and holds the extra ball. Made with 90% polyester, 10% elastic.

SIZING:

- Small - waist 24" to 27"
- Medium - waist 28" to 31"
- Large - waist 32" to 35"
- XL - waist 36" to 40"

Tourna® Ball Claw™

Clips to your waistband. Folds flat, so it can be carried in pocket. Takes up less space on hook at retail.

Patent # 532,197 S # CLAW - 1



Opens to hold

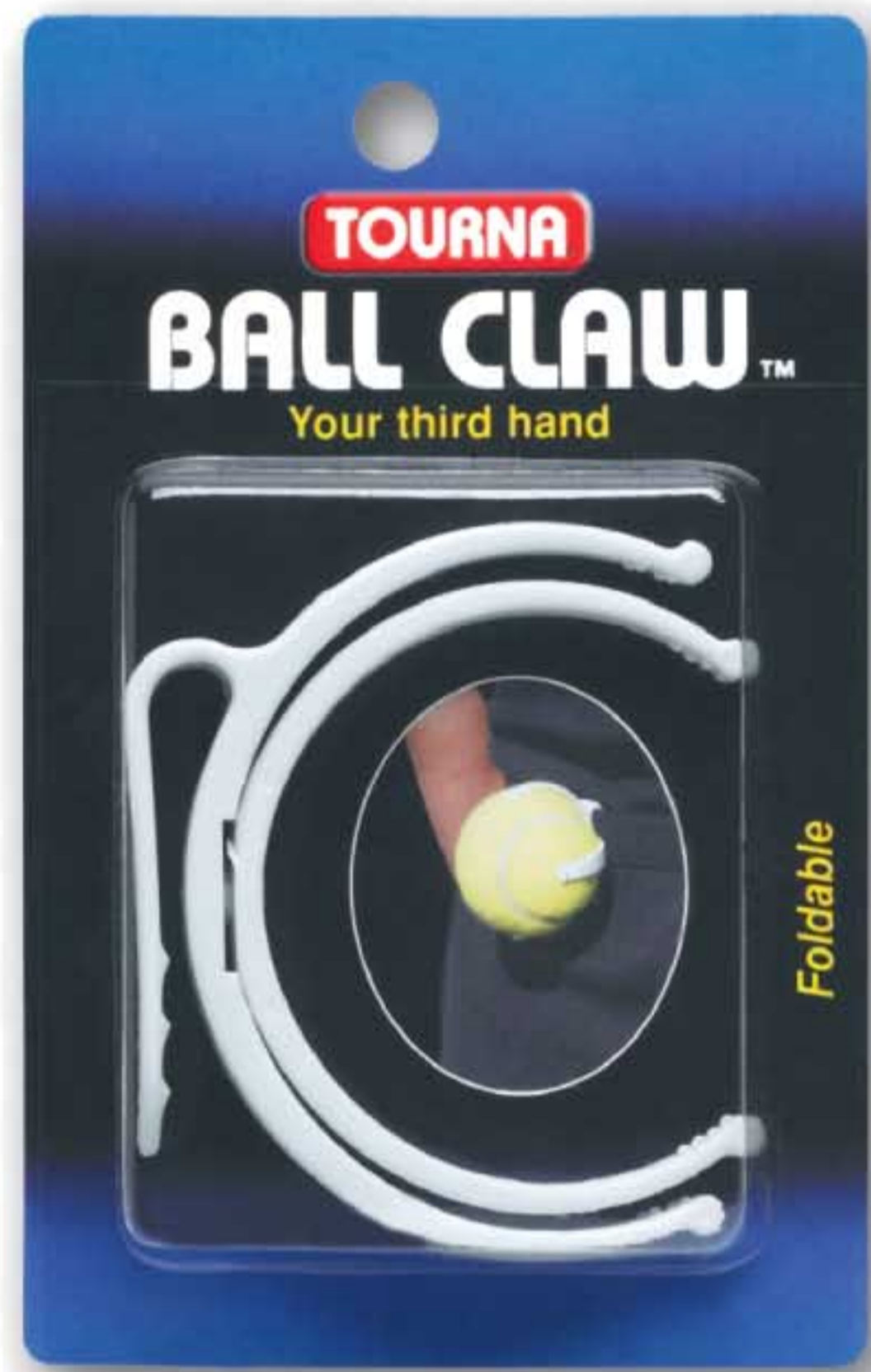

Folds Flat



Tourna® Ball Pocket™

Clips to waistband and holds ball. Comes in clear & white.

- # POK-1 Clear
- # POK-W White



Jumbo Tennis Balls

Ideal for gifts, displays and tournament autographs. Made with real tennis ball felt. Balls are packaged in mesh pack with base at bottom for display.

- # TB-8 Large - 8" (diameter)
- # TB-9 Jumbo - 9 1/2" (diameter)



9 1/2"



8"

Tennis Key Chain

Miniature tennis ball key chain. No logo on the ball. Feels like a real tennis ball.

- # SK-T
- # SK-TJ (Jar display) holds 36



Tourna® RESTORE®

Extends life of tennis balls!

Stores balls after a tennis match. When Restore is closed it will compress air to 14 PSI which is equal to the pressure of unopened can of tennis balls.

Once a can of balls is opened, the balls will become flat in a few weeks even if you never played with them. Storing balls in RESTORE stops further pressure loss so you can play few more sets even weeks later.

You can test that it's holding air pressure by submerging Restore into a sink filled with water. No bubbles means it's holding air pressure.

IT REALLY WORKS!

RST-3



Tourna® SPECS Blue

The Tennis Ball Sunglasses!

Also great for Pickleball.

The yellow ball really stands out with the blue lens Tournas Specs! It gives you the visual edge for outdoor play. Lenses are shatterproof.

- UV coated for 100% sun protection
- Made of shatterproof polycarbonate
- Passed ASTM F 803-97 tests with ball striking it at 100 MPH
- Adjustable temples
- Prescription adapter available for corrective lenses
- Lightweight nylon frames

- # TS-B Adult
- # TS-BY Junior / ladies
- # TS-PA Prescription adapter



SERVE INTO THE SUN WITH EASE !

Yellow ball really stands out.



TOURNA TENNIS Elbow Relief



Top Seller!



Tourna® Elbow Air Cell®

Air pressure pillow delivers 50% more pinpoint pneumatic pressure to the painful tennis elbow joint tendon. The strap is made of elastic stretchable material for constant pressure. The breathable material makes for very comfortable wear.

One size fits all. # CEL-1 White



Aircast® Armband

Pneumatic armband. Compression band for relief of elbow joint pain. It fits comfortably over tendon. Made of breathable material for comfort when wearing. Universal size.

AIR-1



SPIRO® Elbow Guard®

Time tested and patented since 1980. It allows tennis play without further injuring the inflamed elbow. The soft aluminum bar makes it work. The bar contours to the arm and dissipates shock and vibration. Time tested and proven to work.

STE-M Adult / # STE-J Small
STE-X Assorted patent # 4,014,327



Elbow Guard Rx®

Relieves elbow pain (commonly called Tennis Elbow and Golfer's Elbow). Just place Guard Rx around arm below the elbow. The strap stretches and moves with the arm while keeping constant pressure on the sore tendons. It does not slide down your arm as you sweat. Comfortable to wear for long periods of time.

GDRX-1 (6/cs)



Tennis Elbow Guardit®

Relieves elbow pain with compression. Part of the strap is elastic so it offers infinite tension adjustments. It moves with your arm rather than just compressing it in one fixed position. Foam cushion construction. Comes with anti-pinch leather flap. Full healing exercises included in the package. Foam cushion construction.

EG-1



SQ-3 Pack of all 3



NEW! SQUEEZIT™

Now in 3 Resistance levels

- Red - Soft Squeeze
- Blue - Medium Squeeze
- Purple - Hard Squeeze

Just keep squeezing with increasing pressure to achieve rehabilitation for wrist, hand, tennis elbow, and forearm. We call it "Therapy in every squeeze".

SQ-R - Red; # SQ-B - Blue; SQ-PR - Purple
SQ-3 - SET of three resistance therapy balls



Fingerlings™

3 Finger Resistance Tensions

- Helps to rehab tennis elbow, golf elbow, carpal tunnel, tendinitis, arthritis
- Wrist strengthening
- Will help prevent injuries

NEW!

FING-3



Coin & Clip Holder

Elegant Gold plated coin holder.
Can engrave for trophy or gift.

UG-17



Book Ends

Tennis racquets are gold plated. Base is nickel plated. Engrave for trophy or gift. Makes an elegant statement on a book shelf.

UG-15

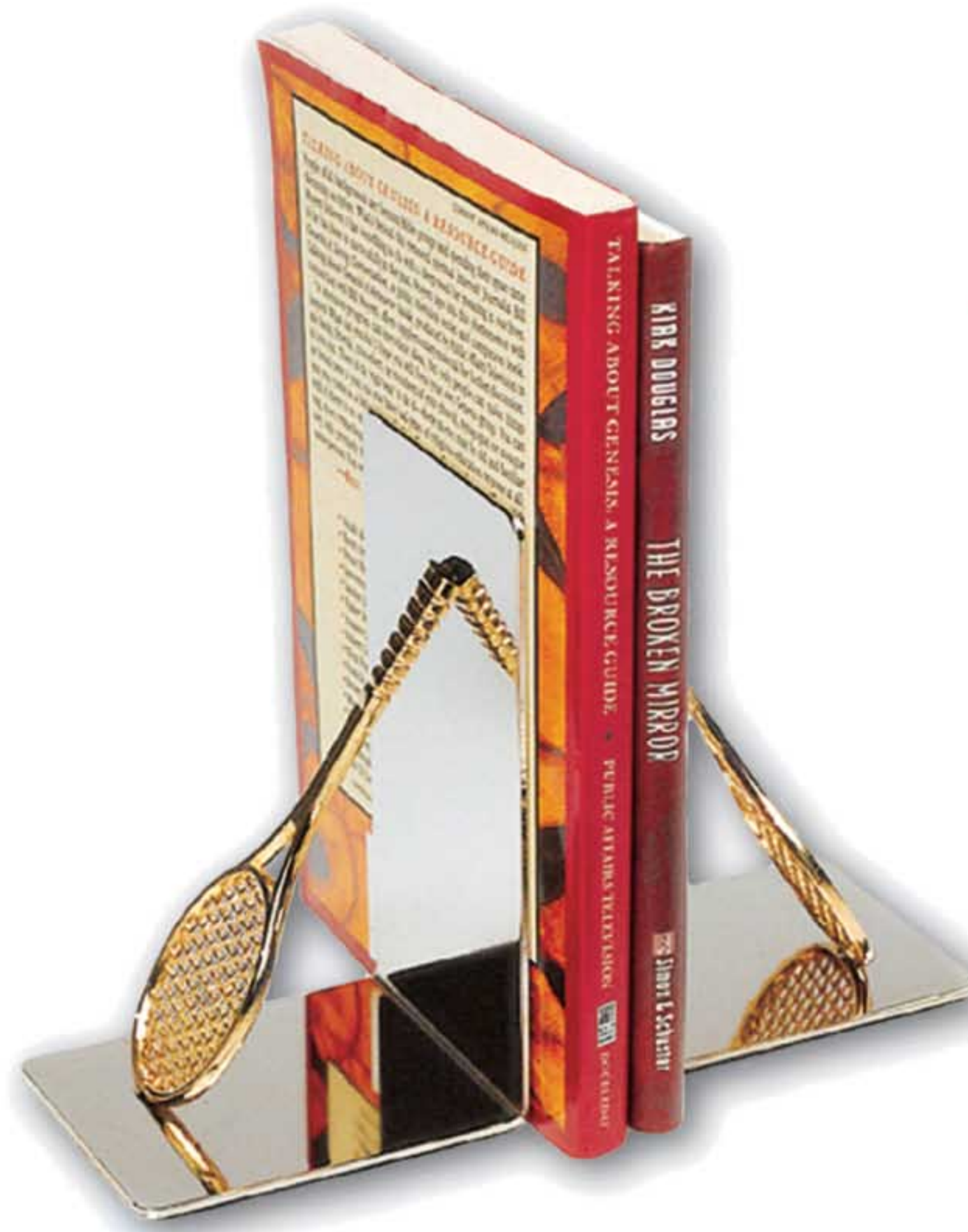

Desk Letter & Note Holder

Racquet is gold plated. Base is nickel plated. Can be engraved. Makes a nice trophy.

UG-9



Letter Opener

Gold plated over brass. Very useful gift.

UG-2



Racquet Bottle Opener

Made of brass and gold plated. Low cost prize gift.

UG-21



Chef Ace™ APRON

This is a standard bib with two side pockets, adjustable neck loop and waist ties.

Tennis ball with chef's cap is displayed on the front. An ideal gift for the tennis buff.

26" long x 27" wide

APR-1 white



Tennis Nut & Bolt Trophy

Nut and bolt design of tennis players. Great for trophy or gift. Metal figurines with a bronze finish look great.

Dimensions: 2 3/4" diameter base x 8" high.

Name of trophy winner and details can be engraved on top of base metal plate. We don't engrave.

NBT-2 Tennis player on spring





To our valued Customers

We take pride in being a family owned and operated business. This marks our 48th year in business.

It started in 1972 with a game-improving grip product on a kitchen table. The tennis market was just starting to explode and we were fortunate to be at its beginnings.

The main office was a two bedroom apartment with a three year old and a newborn. Today, the two babies, Mike and Kevin are full time employees and owners. Our passion and commitment for creative and unique game improving products never ceases.

Over 70% of our products are made in USA.

Products we import are crafted with our owned molds, inspected and then packaged in our US plant. This control delivers quality and timely product for you. Our prices are sharp.

Our drive continues to be on innovative products that create increased sales and profits for you. Tourna Grip and Tourna are our leading product brands in the tennis accessory market.

We thank you for the many years of association. We welcome you if you have not yet done business with us.



Gene Nicksich, Mike Nicksich, Kevin Nicksich
President VP International VP US Sales



TOURNA®

TENNIS STRINGS

TOURNA® Strings are crafted with the latest technology and are second to NONE in performance. You have our **guarantee** with every **TOURNA** string. Encourage your customers to try our High-Performing lower priced strings. They will thank you later with repeat sales!

All our strings are rigorously playtested personally by us, teaching pros, and club level players. It is our mission to craft high quality, arm friendly, playable strings at affordable prices.

ALL **TOURNA** Poly strings are made in Germany using an advanced **polyether** string formulation. The **polyether** delivers a softer string that absorbs shock and increases comfort, while retaining incredible durability, power, and resistance to movement.

Tourna Nylon strings are not as stiff and are friendlier to the player's arms. They are made in Taiwan to our strict specifications. The nylon strings range from premium multifilament like Quasi Gut and Quasi Gut Armour to durable Synthetic Gut and economical Nylon.



String	AWARDS	Date Tested
Big Hitter Black 7	# 1 - Spin among all strings in market	May, 2012 to Date
Big Hitter Blue Rough	# 1 - Control (poly) # 1 - Spin # 2 - Best Overall poly string # 3 - Resistance to movement	February 2011
Quasi Gut Armor	# 2 - Comfort # 3 - Touch/Feel # 9 - Playability # 10 - Power	November 2013
Quasi Gut	# 5 - Overall Feel # 6 - Overall Playability # 7 - Comfort	April 2010
Big Hitter Blue	# 10 - Overall of all strings in market	January 2008
Big Hitter Silver	# 1 - Resistance to Movement # 2 - Durability	May 2004

Awards are based on tests conducted by **USRSA** (United States Racquet Stringers Association.) The test results are compared to all the strings ever submitted for testing.





Top Seller!

#1 IN SPIN



Made in Germany



Tournna BIG HITTER® BLACK 7™

SEVEN sharp edges grab the ball. Soft co-poly, hyper-elastic materials hold the tennis ball until ready for launch. USRSA (United States Racquet Stringers Assoc.) conducted a blind test for 5 weeks (4/2012). The test rated Tournna Black 7 to be the best string for spin of 163 strings play tested.

BLACK 7 is designed for stronger players looking for mid-range power response with pin-point accuracy and massive spin advantage. It allows a player to hit out on the ball and still keep the ball within the lines.

We recommend stringing it 10% lower than current racquet stringing tension.

- 16 gauge (1.30 mm): # BHBK7-16 40 ft (12 m)
Reel: # BHBK7-200-16 660 ft
- 17 gauge (1.25 mm): # BHBK7-17 40 ft (12 m)
Reel: # BHBK7-200-17 660 ft
- 18 gauge (1.20 mm): # BHBK7-18 40 ft (12 m)
Reel: # BHBK7-200-18 660 ft

Tournna BIG HITTER® Blue Rough™

Tournna Big Hitter Blue Rough is extruded with 5 sides and twisted, creating a string with serious bite and spin potential. Out of 149 poly strings ever tested by USRSA these are the results:

- First place in Spin
- First place in Control
- Second highest rated string ever
- Third place in Resistance to Movement

"There is not much to say about the playtest scores other than the fact that "Blue Rough" poly blew the doors off the ratings". USRSA quote

- 16 gauge (1.30 mm): # BHBR-16 40 ft (12 m)
Reel: # BHBR-200-16 660 ft
- 17 gauge (1.25 mm): # BHBR-17 40 ft (12 m)
Reel: # BHBR-200-17 660 ft
- 18 gauge (1.20 mm): # BHBR-18 40 ft (12 m)
Reel: # BHBR-200-18 660 ft

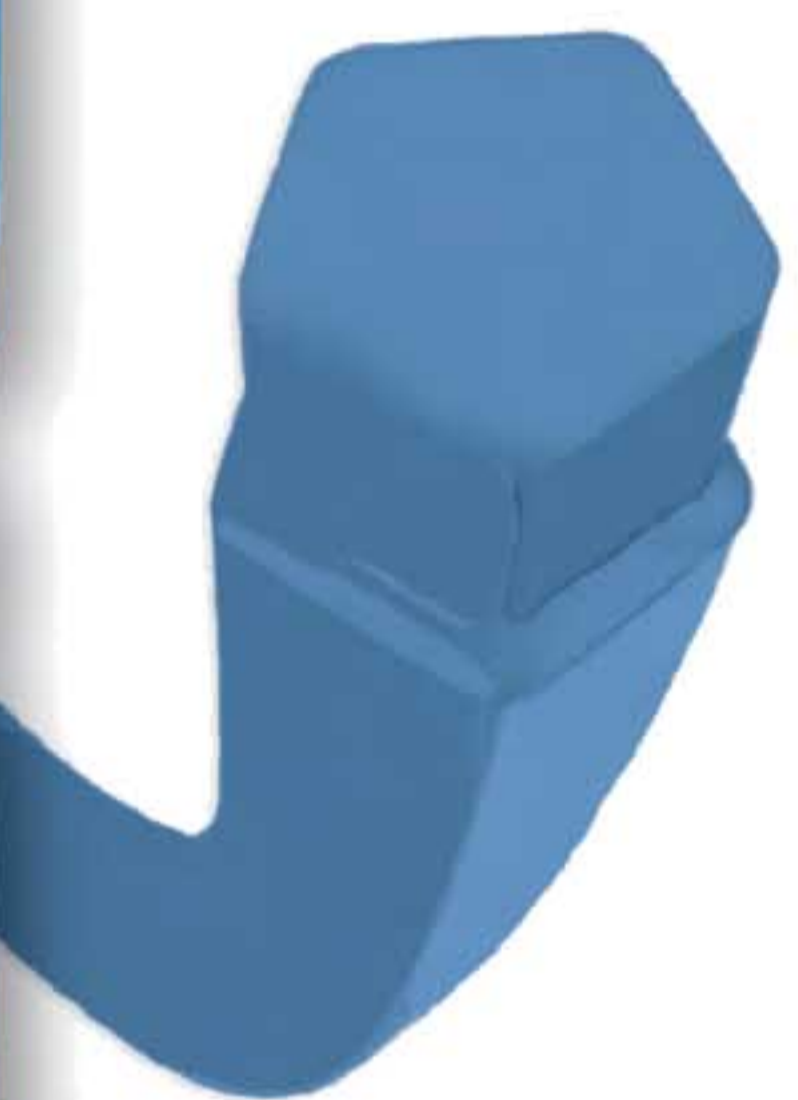

Made in Germany

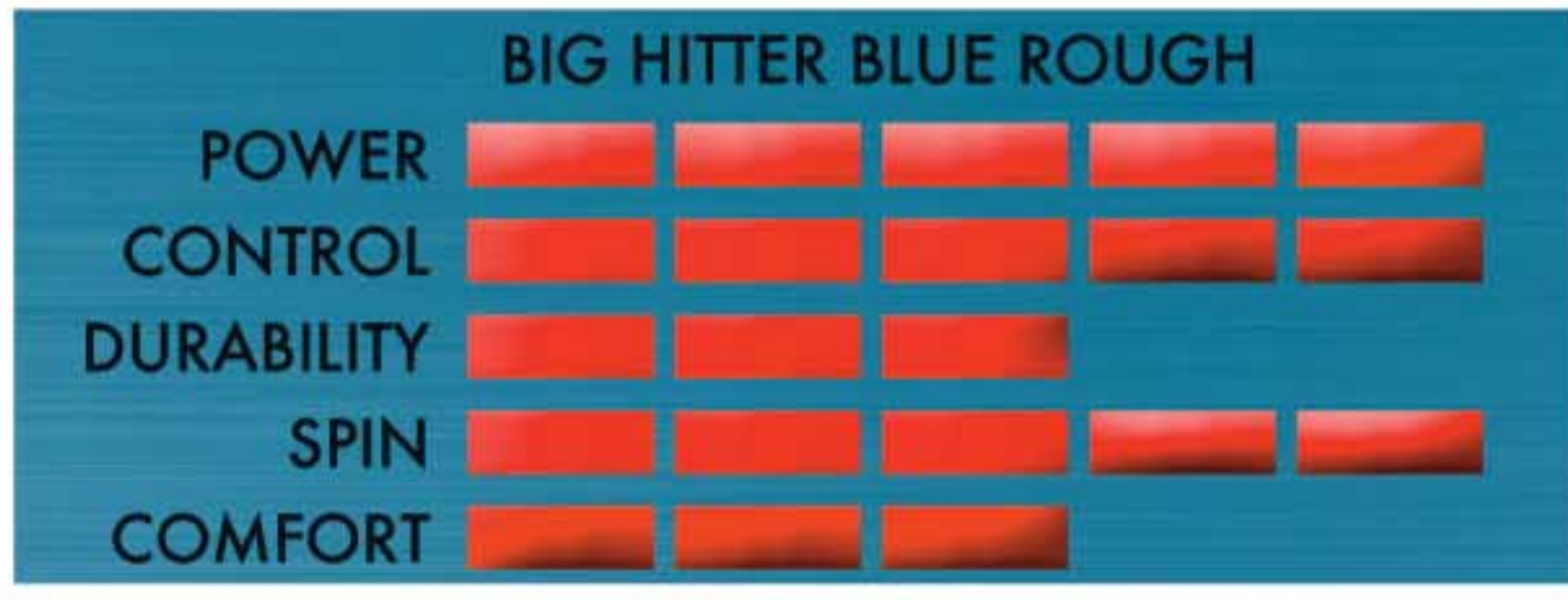

Tournna BIG HITTER® SILVER ROUGH

Tournna Big Hitter Silver Rough is extruded with 5 sides then twisted, providing a string with extra bite and spin potential. Slightly less powerful and more control oriented when compared to the Blue Rough.

- 16 gauge (1.30 mm): # HTR-16 40 ft (12 m)
Reel: # HTR-200-16 660 ft
- 17 gauge (1.25 mm): # HTR-17 40 ft (12 m)
Reel: # HTR-200-17 660 ft
- 18 gauge (1.20 mm): # HTR-18 40 ft (12 m)
Reel: # HTR-200-18 600 ft



Made in Germany



NANO Technology
Tiny strings of graphite less than 10,000x thinner than human hair, yet 100x stronger and 80% lighter than steel. This adds incredible strength to string.

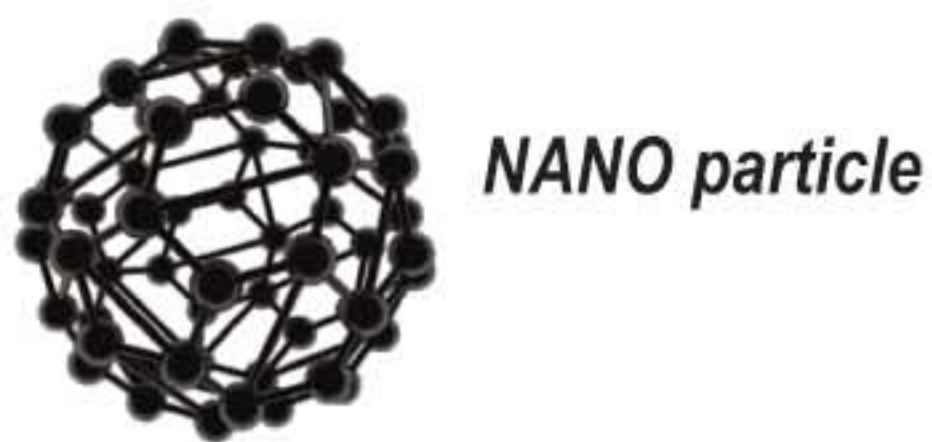

NANO particle

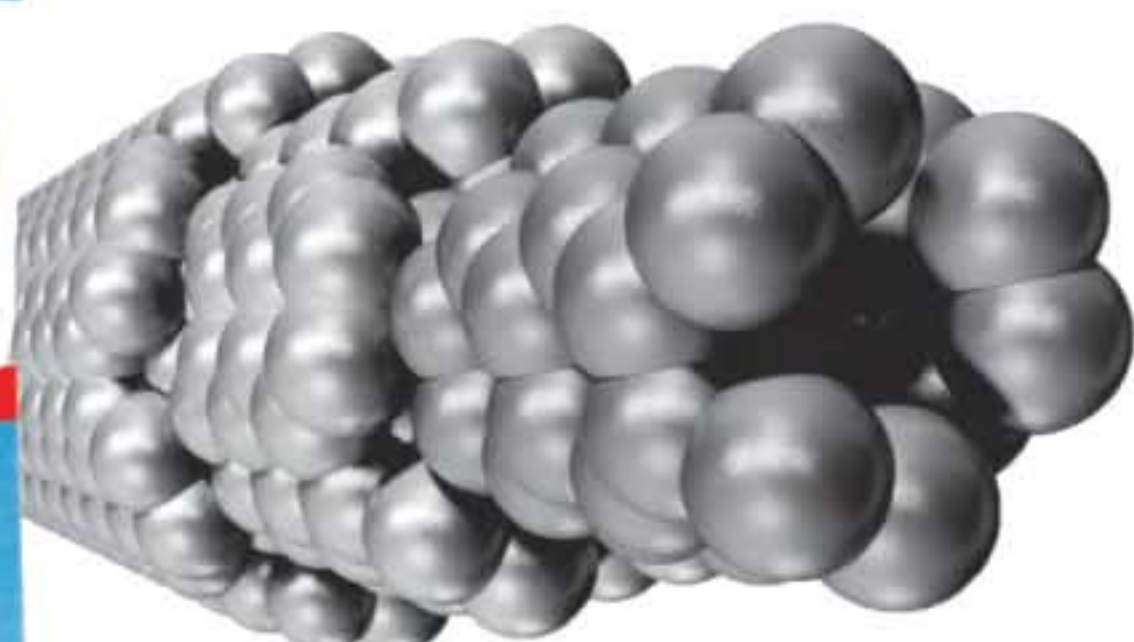

Made in Germany

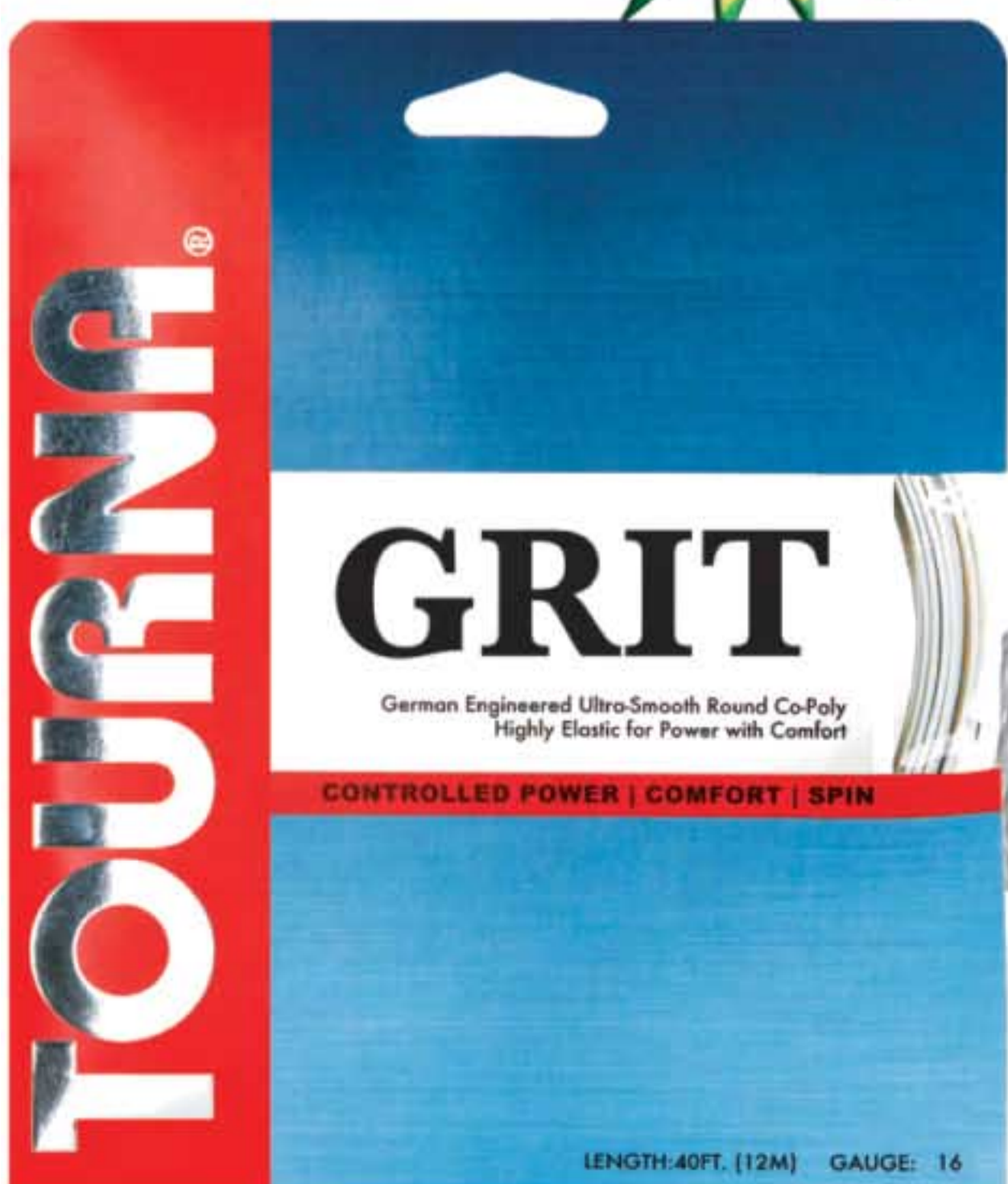

Tournna GRIT™

Featuring new Nano technology completely new development for polyester strings. With 4th generation Co-Poly materials we blend Carbon Fiber Nano Particles. The materials then undergo thermal processing to bond the Nano Particles to the poly-polyether prior to extrusion.

Why all this? The Nano Particles make Tournna Grit extremely elastic, much more than any other poly string on the market. This elasticity imparts incredible "Liveliness", "Feel", and "Pop"! String surface is slightly rough due to nanos. This roughness gives superior spin and extreme directional control. A must string to try.

- 16 gauge (1.30) # GRIT-16-S, Silver ... 40 ft REEL: # GRIT-200-16-S, Silver
- 17 gauge (1.25) # GRIT-17-S, Silver ... 40 ft REEL: # GRIT-200-17-S, Silver
- 18 gauge (1.20) # GRIT-18-S, Silver ... 40 ft REEL: # GRIT-200-18-S, Silver



Made in Germany

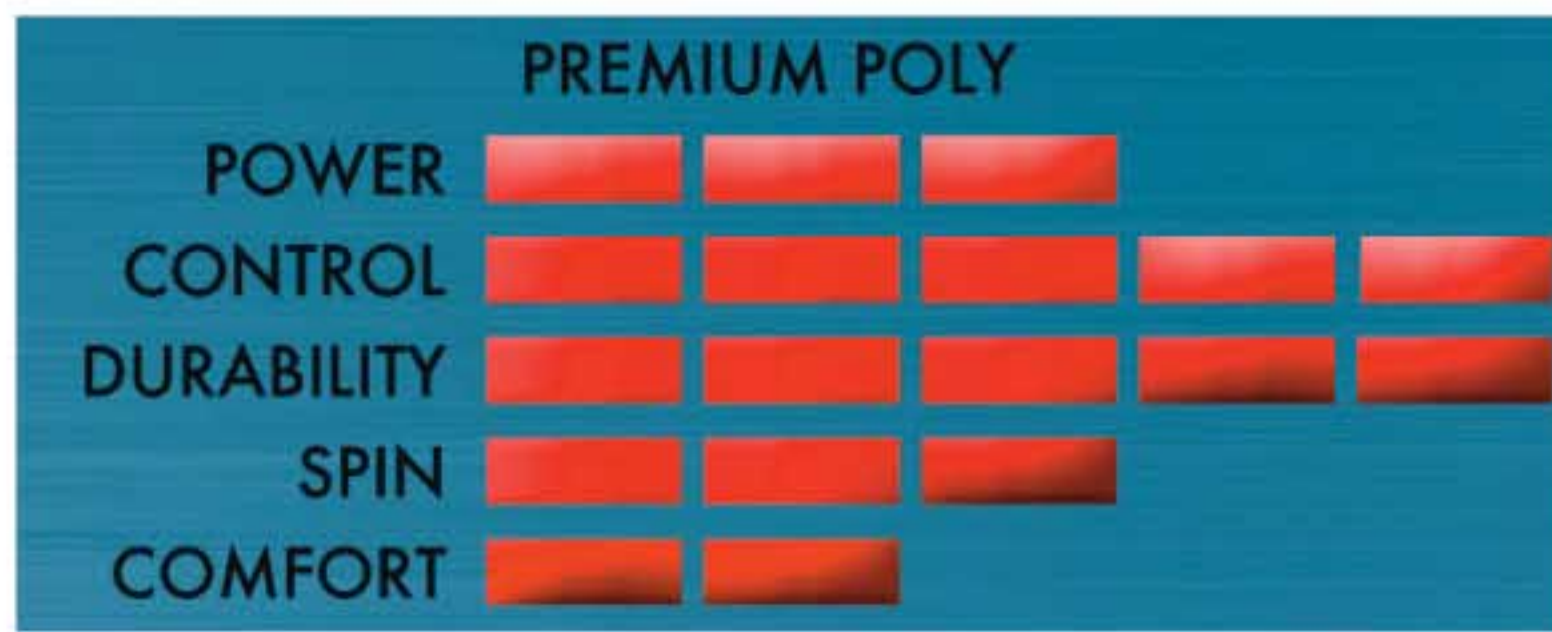

Tourna® Premium POLY

Tired of hearing that strings break so quickly?

Then try TOURNA POLY...very durable string. Made in Germany with special blend of polyester and additives. It is crafted with a superb coating that enhances playability. Designed especially for heavy top spin hitters. Excellent for clay court play. Available in white color only.

- 16 gauge (1.30 mm): # PS-16 (1.30 mm) 40 ft (12 m)
Reel: # PS-200-16 660 ft
- 17 gauge (1.25 mm): # PS-17 (1.25 mm) 40 ft (12 m)
Reel: # PS-200-17 660 ft
- 18 gauge (1.20 mm): # PS-18 (1.20 mm)..... 40 ft (12 m)
Reel: # PS-200-18 660 ft

POLY - Smooth



Tourna® QUASI-GUT™

Quasi-Gut is constructed with thousands of microfibers. Each fiber strand is impregnated and contained in a premium thermo-elastic polyurethane resin. These tightly wound microfibers deliver a sensational gut-like feel and playability at a dramatically lower price. The premium PU resin greatly increases durability and weather shielding as compared to Natural Gut.

USRSA play tests rank it in top 10 of all strings tested. One play tester said: " This is one of the best strings I have ever tested" male 5.0 all court player.

- 16 gauge (1.30 mm): # QGUT-16 40 ft. (12 m)
Reel: # QGUT-200-16 660 ft.
- 17 gauge (1.25 mm): # QGUT-17 40 ft. (12 m)
Reel: # QGUT-200-17 660 ft.

Top Seller!



Tourna® QUASI-GUT ARMOR™

Tourna Quasi Gut - a Nylon string with a touch of Poly. It delivers maximum Comfort & Durability & Touch / Feel. Thousands of multi-filament fibers are wrapped around high tenacity center core and Dupont Nylon center wraps. Durable polyester wraps reinforce the core for durability.

USRSA play tested (summer 2013) and reported:

"Quasi Gut Armor received the second highest rating for Comfort of 175 strings we play tested to date - the only string that bettered it is Natural Gut. To place second only to natural gut for Comfort, is astonishing".

It placed 3rd in Touch & Feel, 9th in Playability, 10th in power. Great for hybriding with co-poly strings.

- 16 gauge (1.30 mm): # QGUT-A-16 40 ft (12 m)
Reel: # QGUT-A-200-16 660 ft.
- 17 gauge (1.25 mm): # QGUT-A-17 40 ft (12 m)
Reel: # QGUT-A-200-17 660 ft

NYLON Strings



Tourna® SYNTHETIC GUT ARMOR

Designed for maximum Playability and Durability. Multi-filament Fibers are wrapped around a high tenacity center core and Dupont Nylon center wraps. Durable polyester wraps reinforce the core to give a longer lasting string. Internal Resin is very elastic to give you that GUT LIKE FEEL. Great for hybriding with co-poly strings.

SYNTHETIC GUT ARMOR offers excellent liveliness, responsive Performance, and Durability. It maximizes touch and control. Available in Black and White.

- 16 gauge (1.30 mm): # SGA-BK-16, Black 40 ft (12m)
Reel: # SGA-BK-200-16 660 ft
- 17 gauge (1.25 mm): # SGA-BK-17, Black 40 ft (12m)
Reel: # SGA-BK-200-17 660 ft
- 16 gauge (1.30 mm): # SGA-W-16, White 40 ft (12m)
Reel: # SGA-W-200-16 660 ft
- 17 gauge (1.25 mm): # SGA-W-17, White 40 ft (12m)
Reel: # SGA-W-200-17 660 ft

Tourna® SYNTHETIC GUT

Synthetic gut is the most widely used string due to economical price and performance. It offers excellent liveliness and gut-like performance.

This is a fine, durable, and super value string. It's multi-filament fibers are wrapped between high tenacity center core and DuPont Nylon center wraps. Proprietary resin is used in crafting process. Internal resin is elastic which mimics the natural gut-like feel.

Colors: Gold.

16 gauge (1.30 mm): # SGG-16..... 40 ft. (12m) ; SGG-200-16 660 ft. Reel
 17 gauge (1.25 mm): # SGG-17.....40 ft. (12m) ; SGG-200-17 660 ft. Reel



Tourna® IRRADIATED

Irradiated technology injects energy into the molecular structure of string to enhance elasticity and lower damping. This means the tennis ball rebounds faster from racquet with less loss of energy.

Natural Gut has the least amount of internal damping (that is a great feature). With Irradiated string you get as close to natural gut as possible, but at a much lower price. Irradiated is constructed with a multi-filament fiber center and surrounded with fine monofilaments which generate exceptional comfort.

16 gauge (1.30 mm): # IR-16 40 ft (12 m)
 Reel: # IR-100-16 330 ft (100 m)
 17 gauge (1.25 mm): # IR-17 40 ft (12 m)
 Reel: # IR-100-17 ... 330 ft (100 m)



Tourna® SPIN PLUS

This string was designed for players who want to maximize spin on their shots. Exceptional spin performance is delivered by the strings unique construction. It has a strong mono center core, with multi-filament fibers and layers for its outer wrap. The spiral outer wraps give it the bite for that extra spin. The faster the swing, the more spin is generated on the ball.

16 gauge (1.30mm): # SP-1640 ft. (12m); Color: mint green

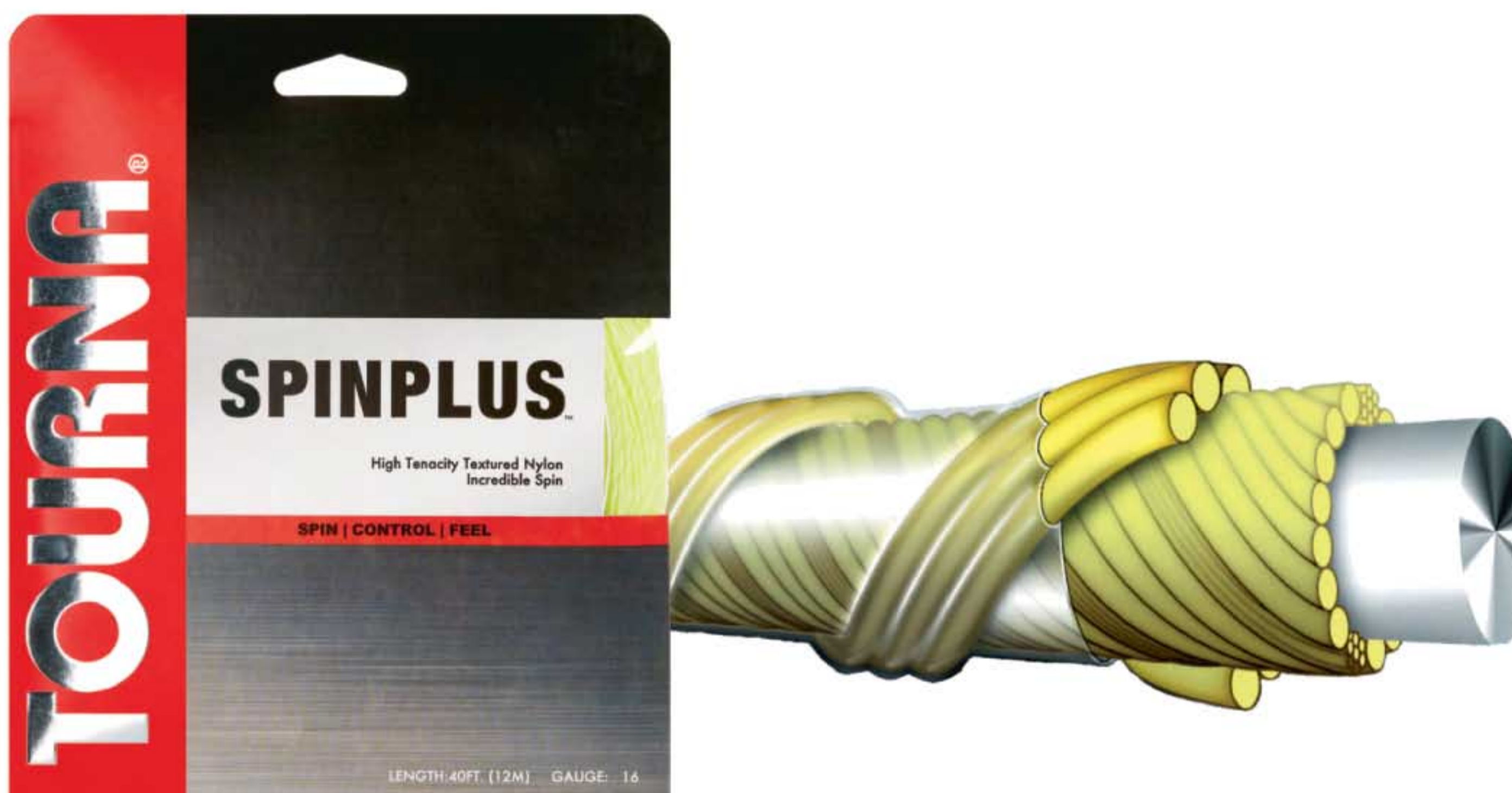

Tourna® NYLON

This is the Original Classic Nylon tennis string. Nylon is still a great combination of power, control and durability at very low cost.

Tourna Nylon is made with single wrap, high tenacity nylon fibers and coated with the latest coating technology. This is an all-around performance string for players on a budget.

Available colors: **White, Gold, Pink, Fluorescent Yellow, Mint Green**

16 gauge (1.30 mm) 40 ft.
 # NP-16 Pink; # NY-16 Fluorescent Yellow
 # NW-16 White; # NM-16 Mint Green; # NG-16 Gold
 REELS: Available in 660 ft. (200 meter)
 in gold and white only: # NG-200-16 Gold; # NW-200-16 White



Precision crafted machine with full warranty for your tennis stringing needs. Tourna brand offers you superior racquet stringing machines at very sharp prices. Every machine is built to precise quality standards. One year warranty on all parts and electrical. Customer service available.

Tourna® 600-ES- Computerized

- Description** • 6-Point Computerized stringing machine with stand
- Uses** • For Tennis, Racquetball, Squash, Badminton
- Tension Setting** • Digital Control panel with advanced stringing functions and programming
- Constant Pull - Lockout** • Microprocessor controlled True Constant Pull Tensioning Extremely sensitive electronic Tensioner with advanced microprocessor technology.
- Tension Range** • Precision tension control from 10-90 lbs. (4.5 - 40.8 kgs) with 0.1 accuracy
- Tension Memory** • 8 programmable permanent tension memory settings
- Tension Unit** • Modular, removable tension unit for easy servicing
- Multi Speed Pull** • 6 selectable pull speeds
- Pre-Stretch** • 4 levels of pre-stretch (5%; 10%; 15%; 20%)
- Knot Tensioning** • Knot Function increases tension on Tie-Off Pulls
- Pounds & Kilos** • Easy Lbs / Kgs conversion key
- Calibration** • Calibration adjustable with electronic or manual calibrator
- Timer Function** • Convenient Timer Function
- String Gripper** • Diamond coated rotary String Gripper - quick and accurate one handed tensioning
- Mounting System** • 6-Point self leveling Quick Mount System with load spreaders at tip and throat
- Side Arms** • Articulated side arms (single knob adjustable) for ultra convenient and secure mounting
- Side Supports** • Adjustable large metal V-shaped side supports
- Self Centering adjustment** • Self centering lever on mounting stand for fast adjustment
- Turntable** • Octagonal, space saving turntable, Full 360° degree turntable rotation with brake
- Clamps** • 5-Tooth, slim profile, quick action, rotating swivel clamps Durable all metal construction. **Oversize Base and Locking Arm -- easy to maneuver. Super quick cam-like mechanism. Clamps lock securely & easily to table. Finger tip adjustable - no tools needed.**
- Foot Pedal** • Foot pedal included
- Stand** • Sturdy, height adjustable metal stand (30" - 34.25"), with leveling pads and Reel Rack.
- Base & Tool Tray** • Sturdy base for table top use - features large tool tray
- Base Ruler** • Built in ruler
- Tools included** • 1 straight awl, 1 straight pliers, hex wrench set & wrench
- Warranty** • 2 year limited parts with 1 year limited electronics
- Total weight** • 115 lbs (52 kgs)
- Packing** • Tension head - cubic feet 4.1 (32" x 15.25" x 15")
Mount & stand - cubic feet 4.4 (29.5" x 17.75" x 14.75")
- Stock number** # 600-ES



2 year mechanical warranty
1 year warranty electrical

Microprocessor controlled true constant pull tensioning system. Extremely sensitive electronic tensor with advanced microprocessor technology.



6 point leveling - quick mount system with load spreaders at tip & throat



Control Panel



5-tooth, slim profile, quick action, rotating swivel clamps - with finger tip adjustment requiring no tools.

FREE TOOLS



Every stringing machine comes with a complete set of tools to assemble and to string racquets

Tourna® 600-EST - Table Top



2 year mechanical warranty
1 year warranty electrical

- Description** • 6-Point Computerized stringing machine
- Uses** • For Tennis, Racquetball, Squash, Badminton
- Foot Pedal** • Foot pedal included
- Base & Tool Tray** • Sturdy base for table top use - features large tool tray
- Base Ruler** • Built in ruler
- Tools included** • 1 straight awl, 1 straight pliers, hex wrench set & wrench
- Warranty** • 2 year limited parts with 1 year limited electronics
- Total weight** • 115 lbs (52 kgs)
- Packing** • Tension head - cubic feet 4.1 (32" x 15.25" x 15")

All other information is listed on previous page (25). It is an identical unit without the floor stand.

Stock number # 600-EST

TENNIS CLAMP



5-tooth, slim profile, quick action, rotating swivel clamp for Tennis and Squash racquets
CLAMP-1

BADMINTON U Support



LSU-1

Floor Machine Cover



Stringing machine Cover.

Fits all Tourna floor standing stringing machines.

COV-1

Tourna® 600-F Floor Stand



Sturdy, height adjustable metal stand. Adjustable height from 30" to 34.25". Unit has leveling pads and Reel Rack. Fits 600-EST

600 - ES-S

BADMINTON CLAMP



4-tooth, slim profile, quick action, rotating swivel clamp for Badminton racquets.

CLAMP-1-B

TRAY



Tool Tray attaches to 600-ES. Sold separately

S-TRAY

Tourna CUBE



Computerized Stringing Machine

Hand brushed in pure stainless steel. An extraordinary electronic stringing machine for Tennis, Racquetball, Squash and Badminton. Here are some of the features:

1. Diablo tensioner for the most delicate strings.
2. 4 levels of Pre-Stretch: 0%, 5%, 10%, and 20%.
3. Precision tension control from 10-90 lbs in increments of 0.1 lbs
4. 8 programmable memory settings - pulling speed, pre-stretch, knot function and internal diagnostics check to store your desired tension.
5. 360 degree swivel turntable with locking break for all around easy access.
6. USB port to charge your cell phone
7. Side tools holder
8. Adjustable height stand
9. Digital control panel for advanced stringing function and programming.
10. 6 adjustable pull speeds from slow to fast
11. 6 point Quick Mount System
12. Lighted cube to add drama to your stringing station
13. Push button base clamp release
14. Auto start string gripper
15. Gravity assisted base clamp release



2 year mechanical warranty
1 year warranty electrical



2 year mechanical warranty
1 year warranty electrical

Tourna 800-ES

This is a superb electronic stringing machine Tennis, Racquetball, Squash and Badminton. Here are just some additional features in addition to all the features on our other machines:

1. Diablo tensioner for the most delicate strings
2. Precision tension control from 10-90 lbs with 0.1 accuracy
3. Eight programmable permanent tension memory settings
4. Auto start string gripper
5. USB port to charge your cell phone while stringing
6. Extra large tool tray with easy access to cell phone
7. Adjustable height stand
8. Temperature and humidity gauge for ultimate customization for the conditions



Tourna® 300-CS - CRANK -with Floor Stand

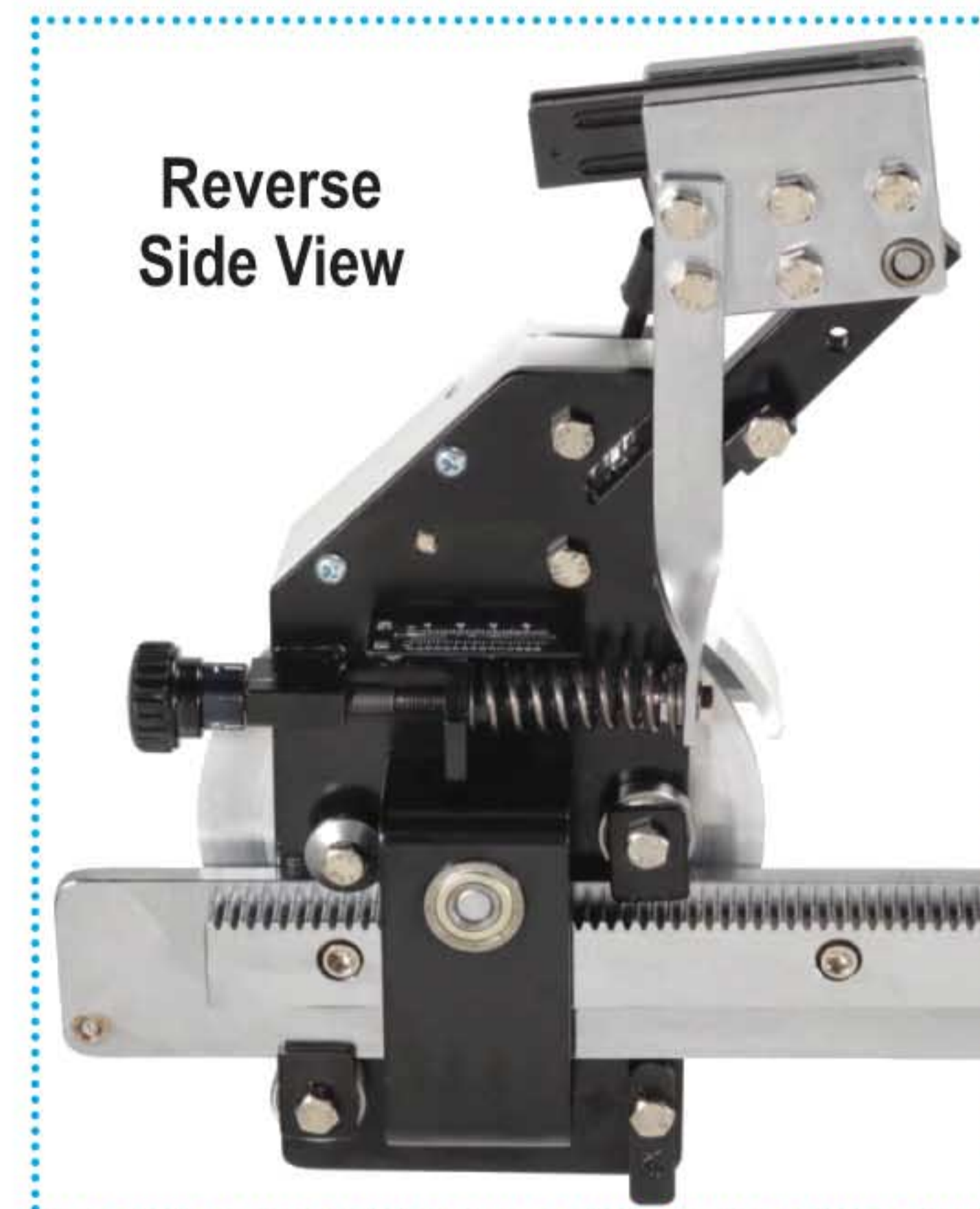

Reverse Side View



2 year mechanical warranty
1 year warranty electrical

String Reel Holder

Tool Tray

2 year limited warranty

- Description**
 - 6-Point manual stringing machine with stand (no table top option)
- Uses**
 - For Tennis, Racquetball, Squash, Badminton
- Tension Mechanism**
 - Manual crank
- Tensioner**
 - Adjustable width linear ball bearing string gripper
- Tension Range**
 - 9 - 102 lbs (4-46 kgs)
- Tension Setting**
 - Spring loaded tension winder
- Pounds & Kilos**
 - Pounds & kilograms scales
- Calibration**
 - Calibration adjustable with electronic or manual calibrator
- Mounting System**
 - 6-Point self leveling Mounting System
- Side Arms**
 - Articulated side arms (single knob adjustable) for ultra convenient and secure mounting
- Side Supports**
 - Adjustable large metal V-shaped side supports
- Self Centering adjust**
 - Easy, large dial under turntable adjusts mounting stand
- Turntable**
 - Full 360° turntable rotation with brake
 - Octagonal, space saving, ergonomic shape
- Clamps**
 - 5-Tooth, slim profile, quick action, rotating swivel clamps
- Feature**
 - Oversize base and locking arm - easy to maneuver
- Locking Mechanism**
 - Super quick cam-like mechanism
 - Clamps lock securely & easily to table
- Adjustability**
 - Finger tip adjustable clamps - no tools needed
- Stand**
 - All metal stand, height adjustable (30.25" - 32.25")
 - Comes with metal string reel holder & tool tray
 - Stand has leveling pads
- Tools**
 - Included: 1 straight awl, 1 straight pliers, hex wrench set, pathfinder awl, razor knife
- Warranty**
 - 2 year limited parts
- Total weight**
 - 64 lbs (29kgs)
- Packing**
 - Cubic feet 6.58 (35" x 14" x 21")
- Stock Number:** # 300-CS

FREE TOOLS

Every stringing machine comes with a complete set of tools to assemble and string racquets



Kids are tired of boring racquet company logos on their strings. Offer them stylish, fun stencils so they can express themselves. When you string their racquet, show them a range of fun stencil choices. Keep them excited and coming back for fun stencils.



SKULL & CROSSBONES
SKUL-S

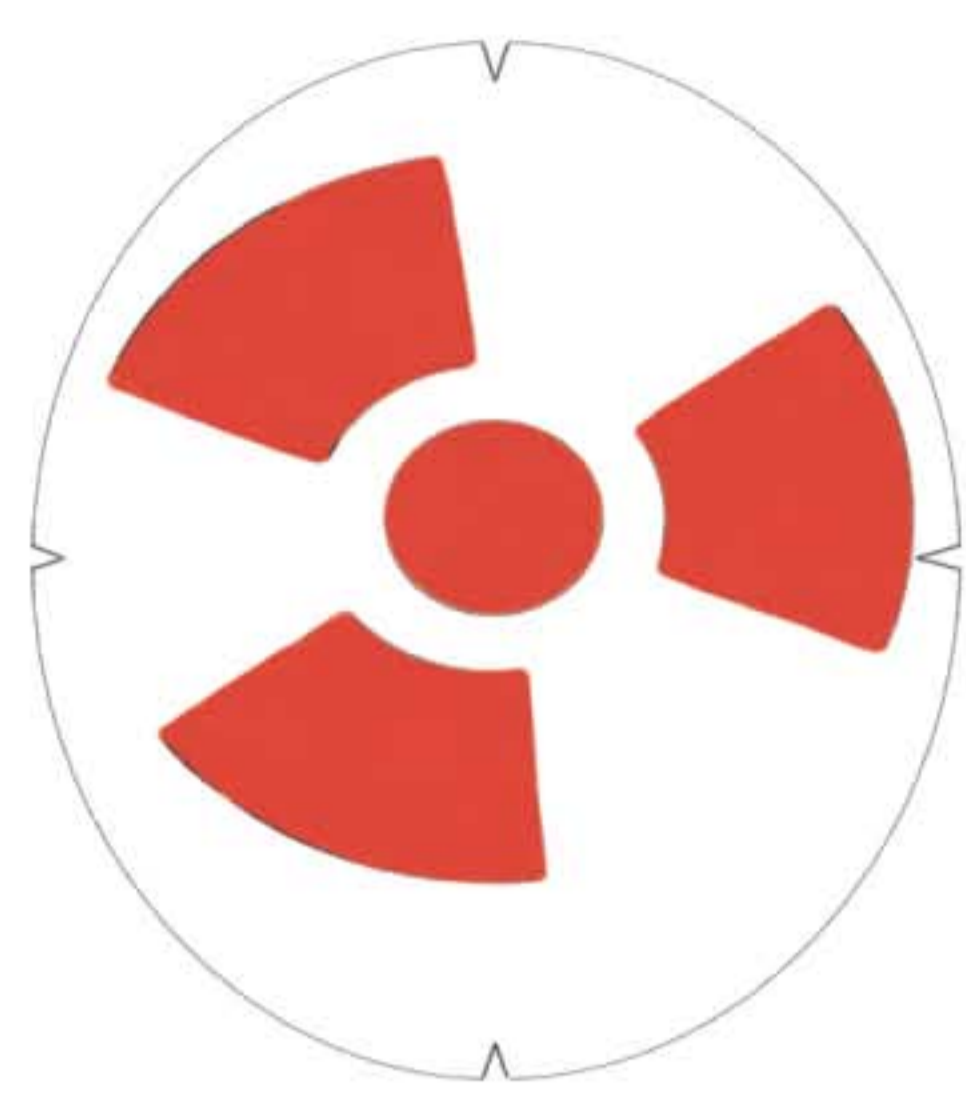

NUCLEAR Symbol
NUKE-S



PEACE Symbol
PEACE-S



HAND PRINT
HAND-S



HOPE RIBBON
cancer fight - # HOPE-S

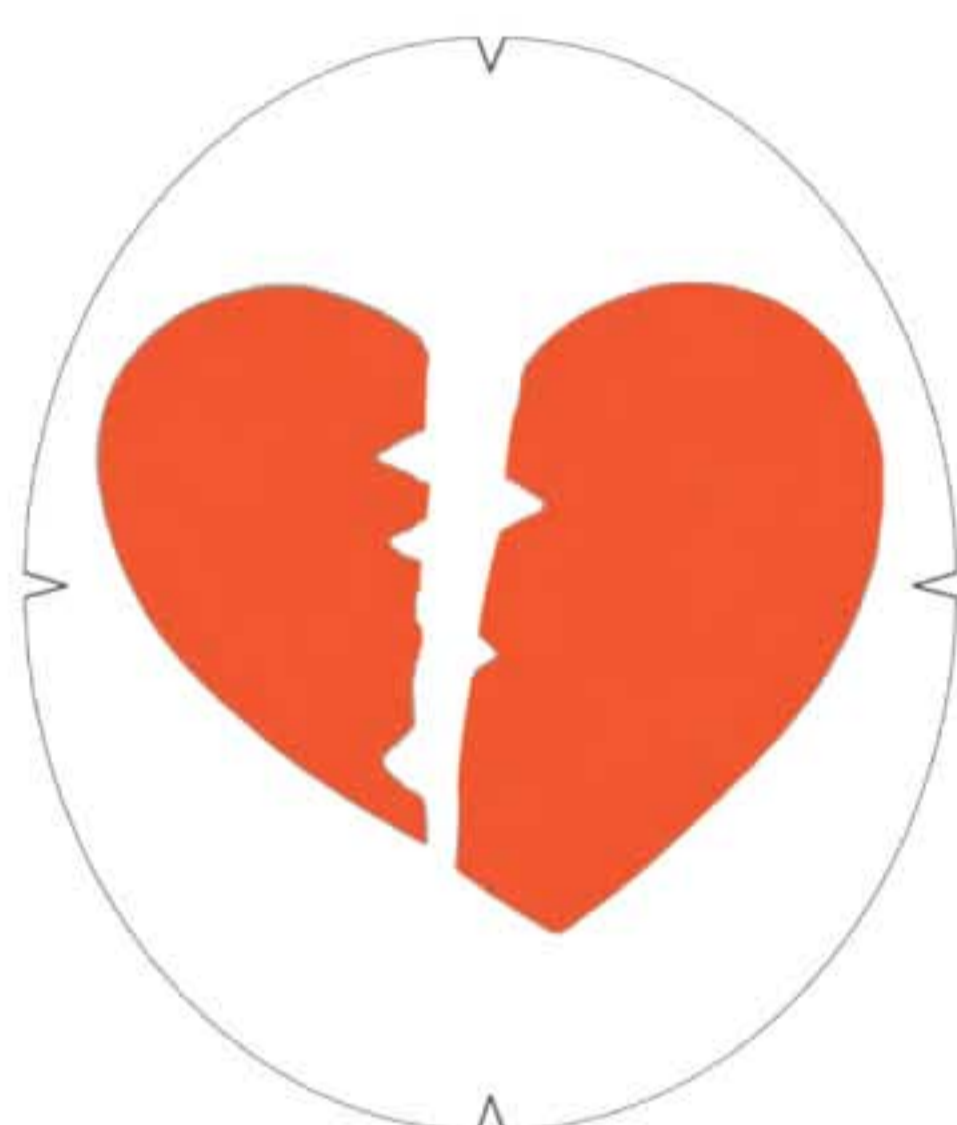

HEART BREAKER
HEART-S



4 leaf CLOVER
CLOV-S



Lucky HORSE SHOE
SHOE-S



SMILEY FACE
SMILE-S



PAW PRINT
PAW-S



CROSS Symbol
CROS-S



STAR
STAR-S

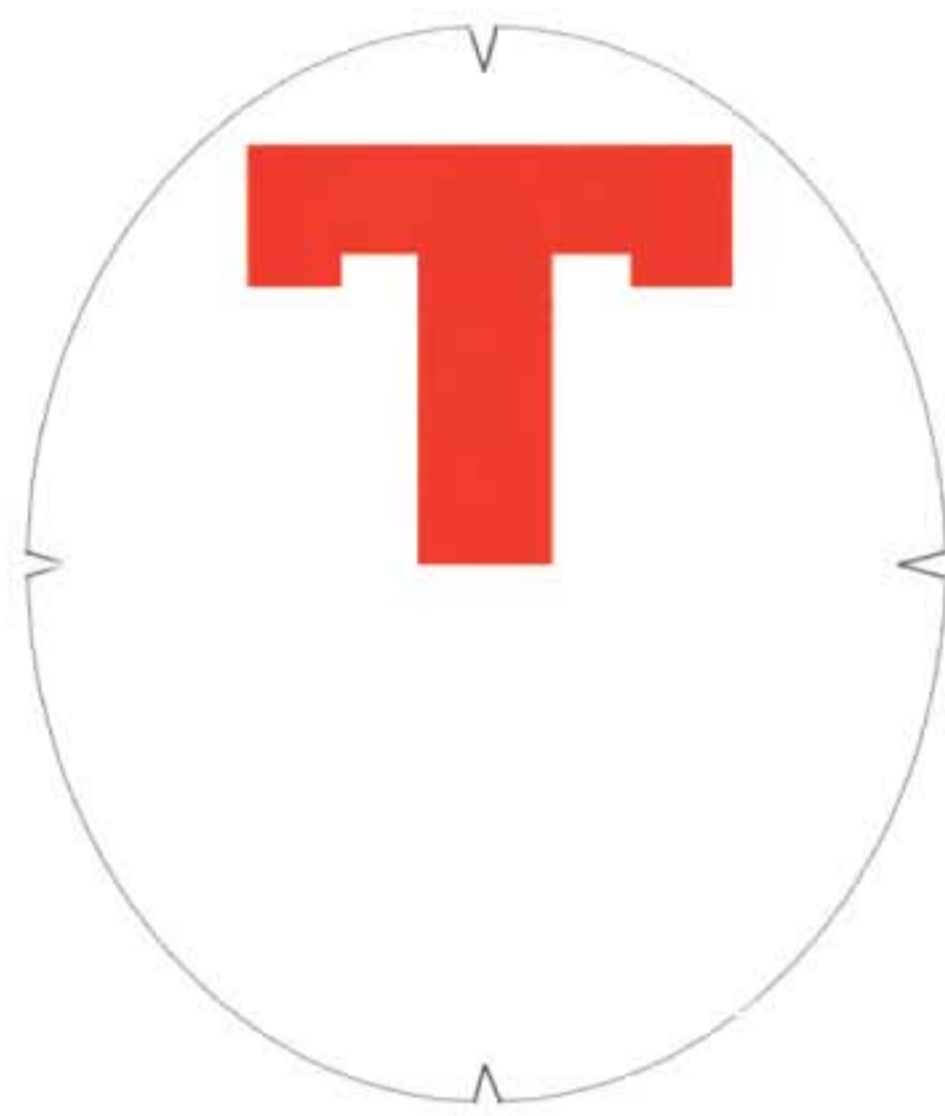

TOURNA Logo
TOUR-S

DIRECTIONS:

- (1) Place newspaper on flat surface and place racquet on top
- (2) Position stencil on strings using "V" cuts in stencil as guides
- (3) Follow directions on Stencil Ink container
- (4) Dab ink into open slots on the stencil covering the exposed strings
- (5) Next, lift the stencil and flip the racquet to do the other side
- (6) Align stencil on strings with inked side against the strings
- (7) Dab on ink on this other side until all exposed strings are covered
- (8) Let racquet dry overnight



Retail package



CONTENTS

TENNIS GRIPS

Tourna Grip	4,5,6,7
Tourna Tac, Mega Tac	8,9
Replacement Grips	10,11
Overgrips - Soft Grip, Soft Tac	12
Grip enhancers	13,14

TENNIS ACCESSORIES

Lead Tapes, Racquet Guard, Butt Caps	15
Hipster, Ball Pockets, Jumbo Tennis Balls	16
Restore Ball Saver, Tourna Blue Specs	17
Tennis Elbow Bands	18
Tennis Gifts	19

TENNIS STRINGS	20,21,22,23,24
-----------------------------	----------------

STRINGING MACHINES	25,26,27,28
---------------------------------	-------------

STRINGING Accessories

Racquet String Stencils	29
Stringmeter & String Accessories	30
Vibration Dampeners	31
Tennis Trainers, Reflex Ball	32

PRESSURELESS Tennis Balls

Pressureless Balls - never go dead	33
Youth tennis balls, Net & Accessories	34,35
Youth Tennis Net, Youth Ball Pick-up	36

TENNIS COURT EQUIPMENT

Ball Pick-ups - Ballport, Tenn-Tube	37,38,39
Teaching Ball Carts	40,41
Score Keepers	42
Squeegees, Baskets & Trays, Tennis Rebounders ...	43
Tennis Nets	44,45
Court Equipment & Benches	46

RACQUETBALL / SQUASH/BADMINTON

Grips, Strings, Accessories	48,49
-----------------------------------	-------

PICKLEBALL	50,51
-------------------------	-------

SPORT EYEGUARDS	52,53
------------------------------	-------

Eyeglass Holders	54
------------------------	----

Caps & Visors	55
---------------------	----

LIQUI COOL & TOWELS	56
--------------------------------------	----

SWEATBANDS

Head & Wristbands	57,58,59
Embroidery	60
Country Flag Bands	61

REFLECTIVES	62,63,64
--------------------------	----------

GOLF Accessories	65,66,67
-------------------------------	----------

Sport Medical Supports	68,69
------------------------------	-------

Sport Accessories	70
--------------------------------	----



Mega Wrap Replacement Grip

Pg. 10



Classic Tour Replacement Grip

Pg. 11



Soft Tac Neon Overgrips

Pg. 12



Tourna GRIT Poly String

Pg. 21



Tourna CUBE Electric Stringer

Pg. 27



VibreX Neon Dampeners

Pg. 31



Classic Ballport 120 Holds 120 Balls

Pg. 39



Net Scorer Slides over net; Score up to 9

Pg. 42



Rally Pro Tennis Practice Rebounder 7' x 7'

Pg. 43



Pickleball Tube Picks up to 18 pickleballs

Pg. 51



FLAG BANDS Bands of 10 countries

Pg. 61



FINGERLINGS 3 Resistance Hand Exerciser

Pg. 69



SQUEEZITS 3 Resistance Exercise Squeeze Balls

Pg. 18, 69



STRINGMETER®

Tennis • Racquetball • Squash
String Tension Measuring Device

String tension is one of the most important factors in the performance of your equipment. Even the best racquet will play poorly if not strung well. It is difficult to estimate tension and monitor tension loss over time.

STRINGMETER eliminates the guessing, plucking & tapping strings to measure tension. In minutes it gives easy and accurate readings of string tension and tension loss. It lets you know if your racquet was strung to your preferred tension, and lets you know when its time to restring (usually 5 to 10 lb of tension loss).

- Measures string tension
- Measures tension in lbs and kilograms
- Measures main string tension during the stringing process
- Measures string size

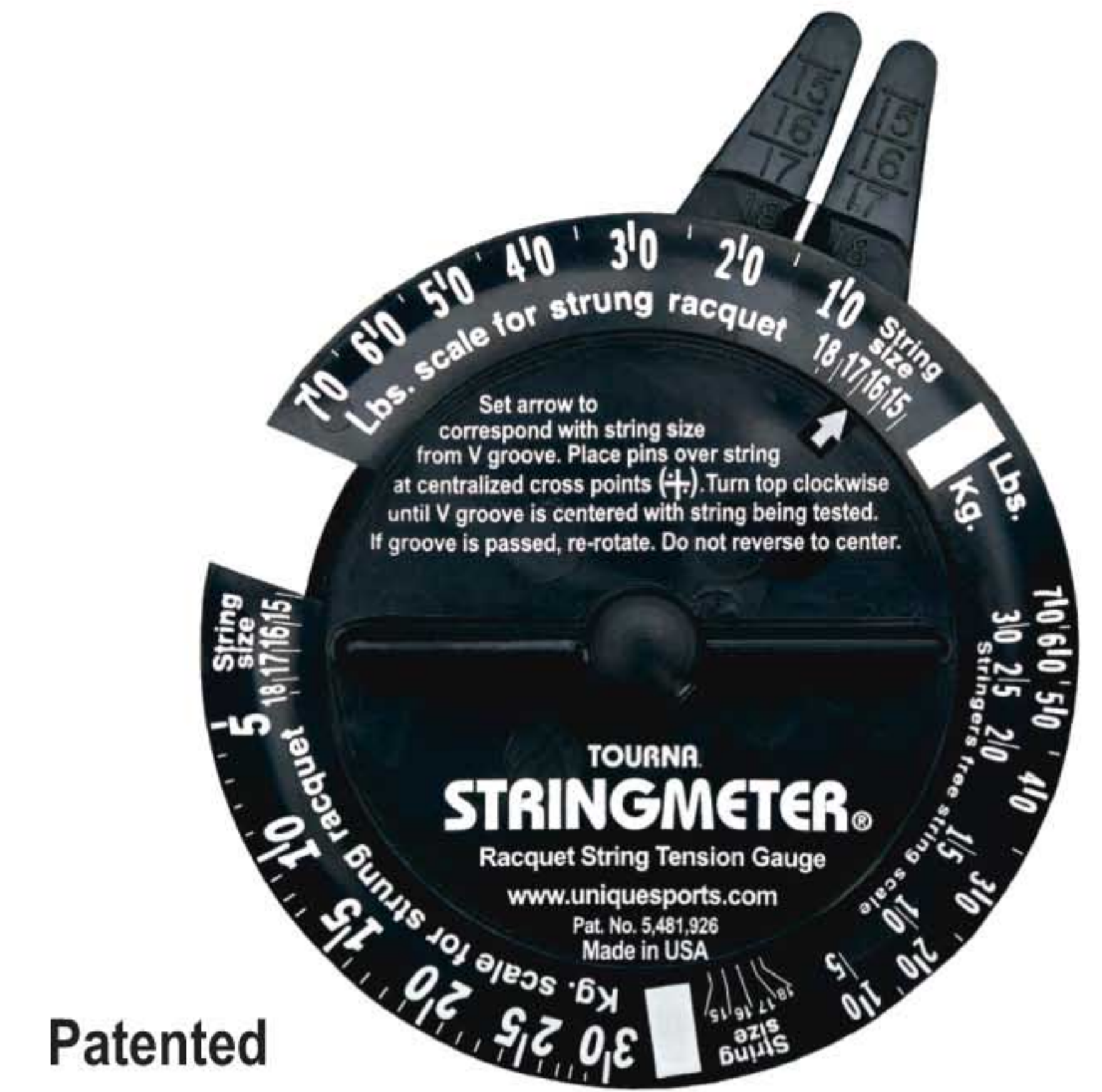

Patented



KNOW YOUR STRING TENSION FOR BETTER PLAY
METER-1

TOURNA CROSS®

Reduces string movement by locking strings in place. Applicator tool makes it easy so that you can insert the cross piece with one hand. Strings will not rub against each other. Tourna Cross will extend the life of strings.

Tourna Cross imparts more spin when ball is struck - crosses bite the ball.
Endorsed by Pete Sampras.

- # TC-1 Applicator with cross pieces
- # TC-R Refill strips, 10 per pack

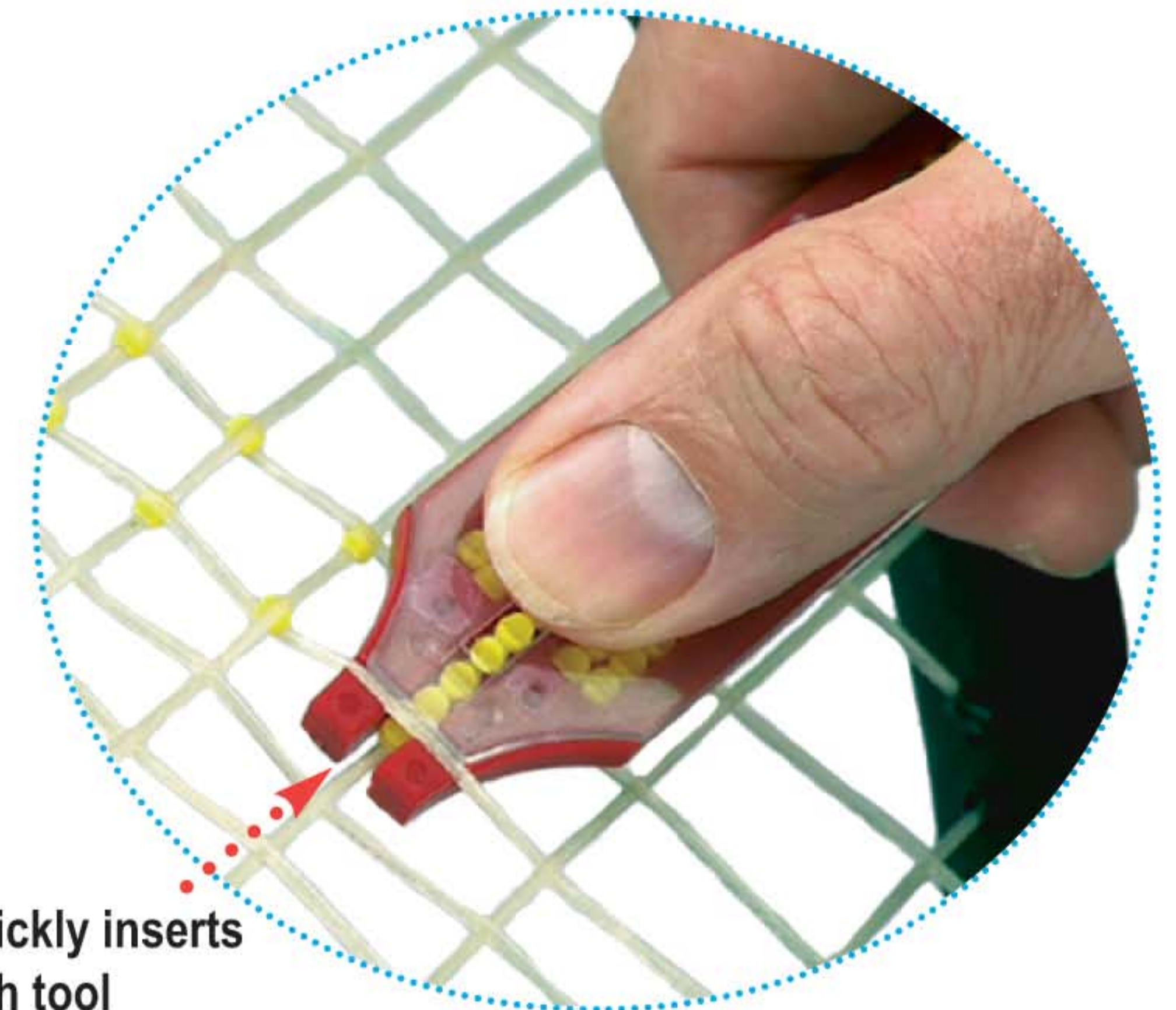

Quickly inserts with tool

STENCIL INK Markers

For stenciling logos on racquet strings. Dries immediately. Bottle has mohair tip applicator so it makes it easy to apply ink.

- # RSI-BK Black
- # RSI-B Blue
- # RSI-R Red
- # RSI-W White
- # RSI-P Pink
- # RSI-NY Neon Yellow



New improved dispensing bottle



Mohair Tip Marker

Top Seller!

Pete Sampras Vibration Dampener

Made popular by Pete Sampras. The center hole minimizes resistance to air when racquet is swung. One of the best string dampeners available. Works on all racquets.

- # VIB-0 Black/Red (12/cs)
- # VIB-0-BK Black (6/cs)
- # VIB-0-W White (6/cs)
- # VIB-0-R Red (6/cs)



VibreX® Scorpion

Surrounds all the vertical string for max dampening. Quickly clips on. Made of stretch ribbed silicone. Colors: red, blue, yellow, white

VIB-S

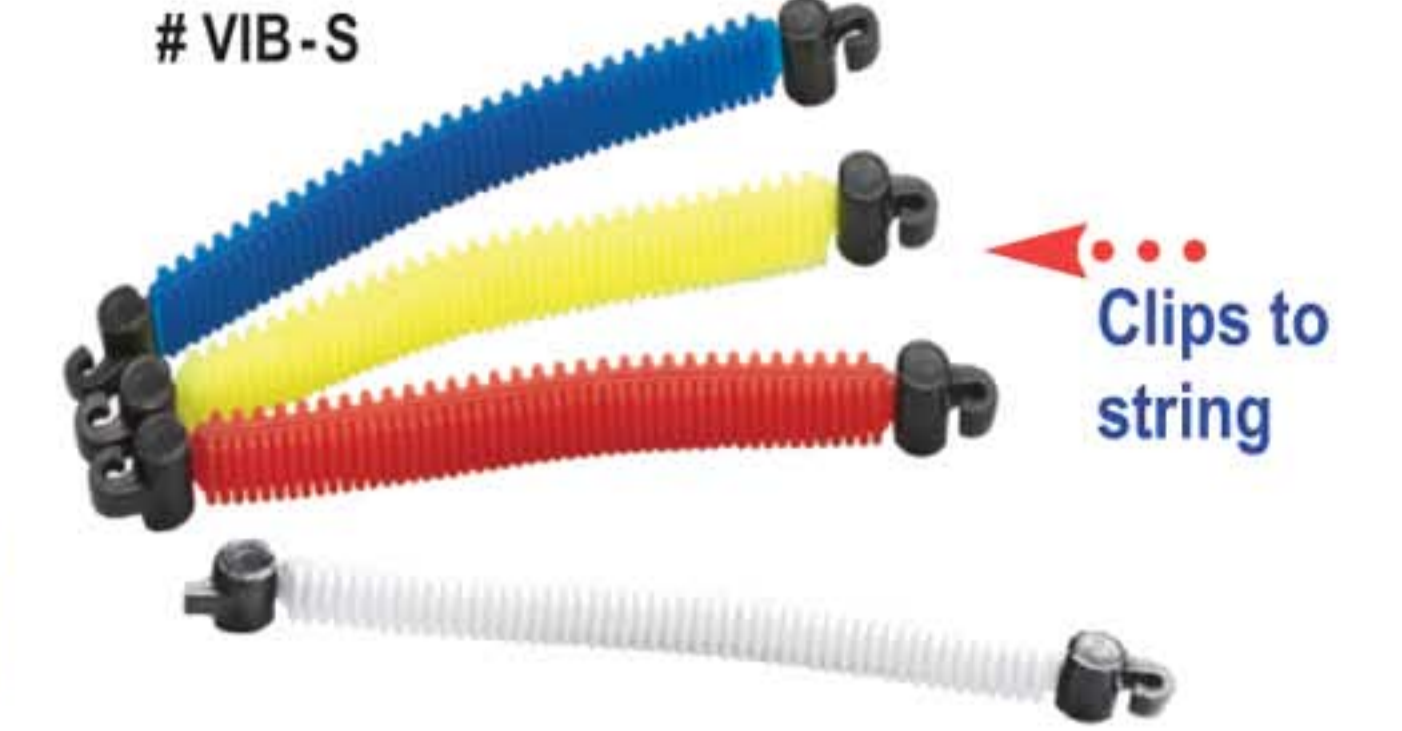

VibreX® SPONGE



Foam Silicone Rubber



The Original invention that started it all. Silicone rubber is in the center between two foam pieces. Very effective. It stays on the racquet.

patented
VIB-2

VibreX® Shock Off™

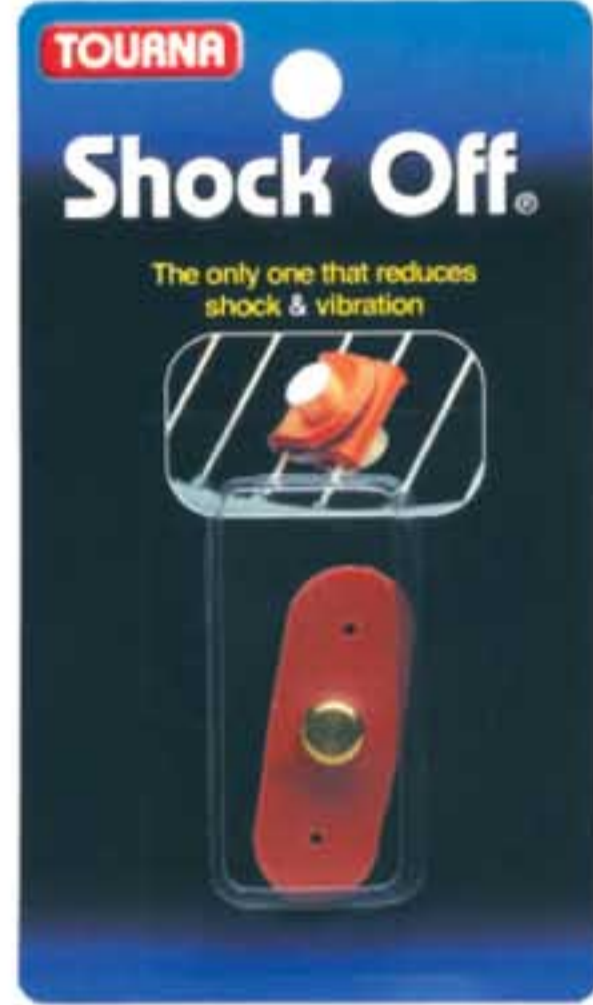

Brass Silicone



Engineered to stop frame and string vibration. Tests show that the brass in the center of the silicone vibrates and cancels the frame vibration.

OFF-1

VibreX® Shock Off 2™

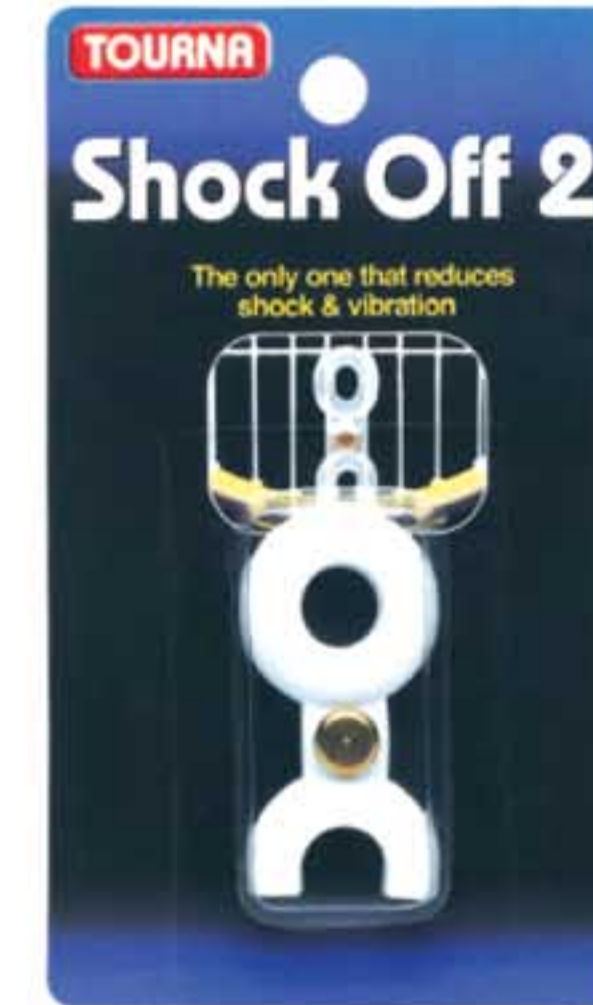

Brass Silicone

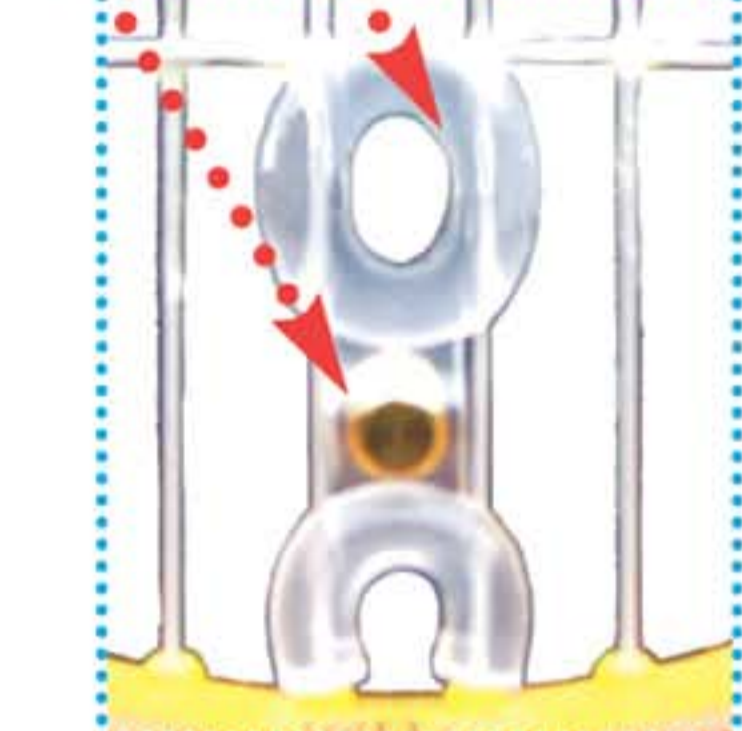

Tests show that the brass weight in the center of silicone mass vibrates and counteracts against frame and string vibrations.

OFF-2 (White, Clear)

VibreX®



Made of silicone. Available in yellow, red, blue, purple. Two per package. Very effective in stopping string vibration. **Sharp price.**

VIB-1



VibreX® Neon



Made of silicone. Available in NEON yellow, green and orange....3 per pack. Makes a fun statement. Very effective in ending string vibration.

VIB-NX



Tourna® Damp

JUST TIE IT ON. Simple yet effective. Made of UV protected synthetic latex.

TDP-5 5 DAMPS per package



Adds FUN to kids tennis !

VibreX® Flower



Girls will be girls. Let them have a daisy vibration dampener. It stops racquet string vibration while it looks great on a tennis racquet.

VIB-FL



VibreX® Whistling



Makes a noticeable whistling sound. Faster the swing speed, the louder it sounds. Coaches love it as a teaching tool (weak sound - weak stroke). Use as prize to motivate during lesson. Insert two on a racquet for a louder sound.

VIB-W patent # 7,530,910 B1



VibreX® Spider



Boys will be boys. Let them have their own scary dampener. It looks like a creepy, crawling spider on a racquet. **Tennis should be fun!**

VIB-SP

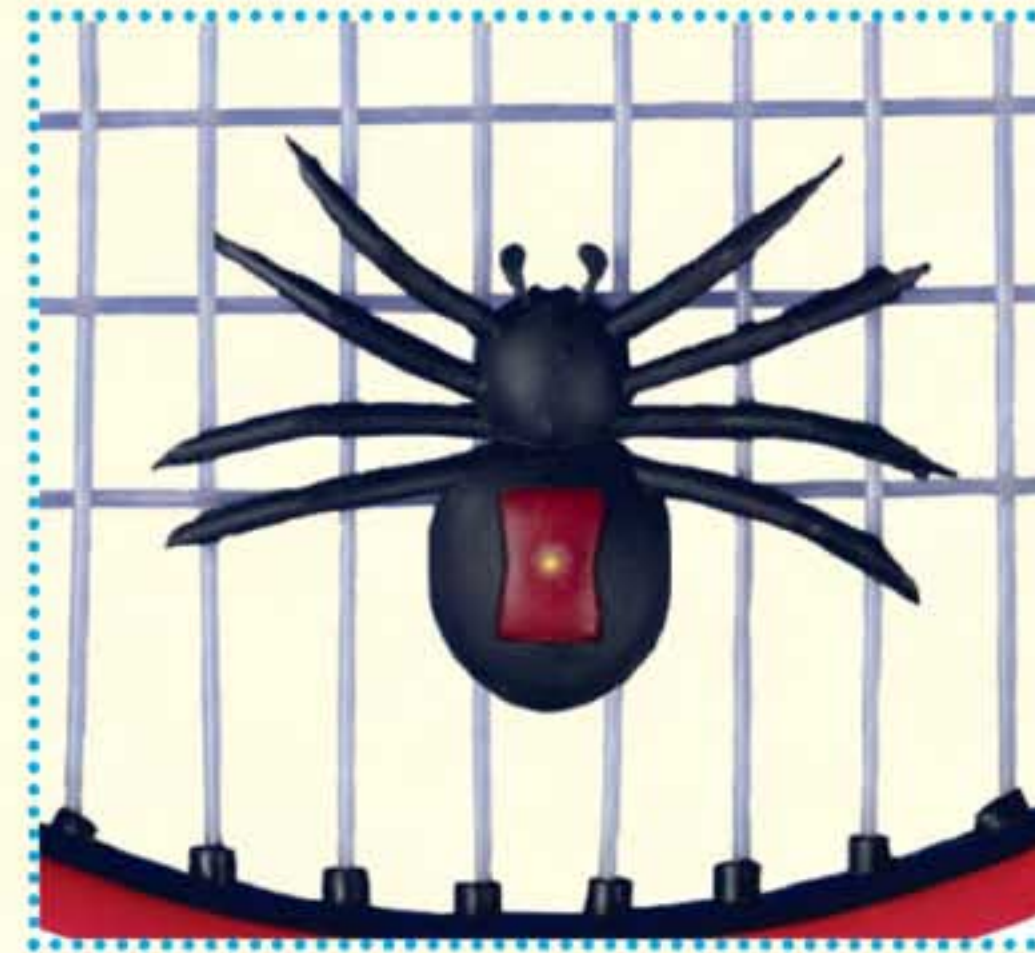

Kids Dampener Jar



Just set it on the counter and watch them sell out.

VIB-JX
Jar holds 24
(8 of each kids dampener)



Pete Sampras

US Patent # D 539,366 S



Fill with water



Wind cord for storage

Hang it on J-hook to display



Pete Sampras Fill-n-Drill®

Practice basic strokes while away from the court. Builds quickness, hand-eye coordination and stamina.

Just fill it with water to anchor the base. Very light when empty so it can be stored and carried easily. Elastic cord winds around base and the ball locks neatly into base pocket. Great practice tool for all levels of play.

Full tennis practice instructions come with package. Cord stretches up to 30 ft.

Endorsed by Hall of Fame legend, Pete Sampras.

FD-1

Pete Sampras Tennis Trainer

Heavy base is filled with concrete. Ball fits in center of unit. Strong rubber cord returns the ball every time. Place on ground and start hitting. Full instructions for practice come with the package. Stack it on a shelf or hang it on a hook.

TTS-1

Stack it on shelf or hang on hook



Reflex Tennis Ball

Reflex ball is a great teaching aid to sharpen reaction skills. It gives an unpredictable bounce when thrown against the ground. Daily practice for 10 minutes will do it.

RFX-1

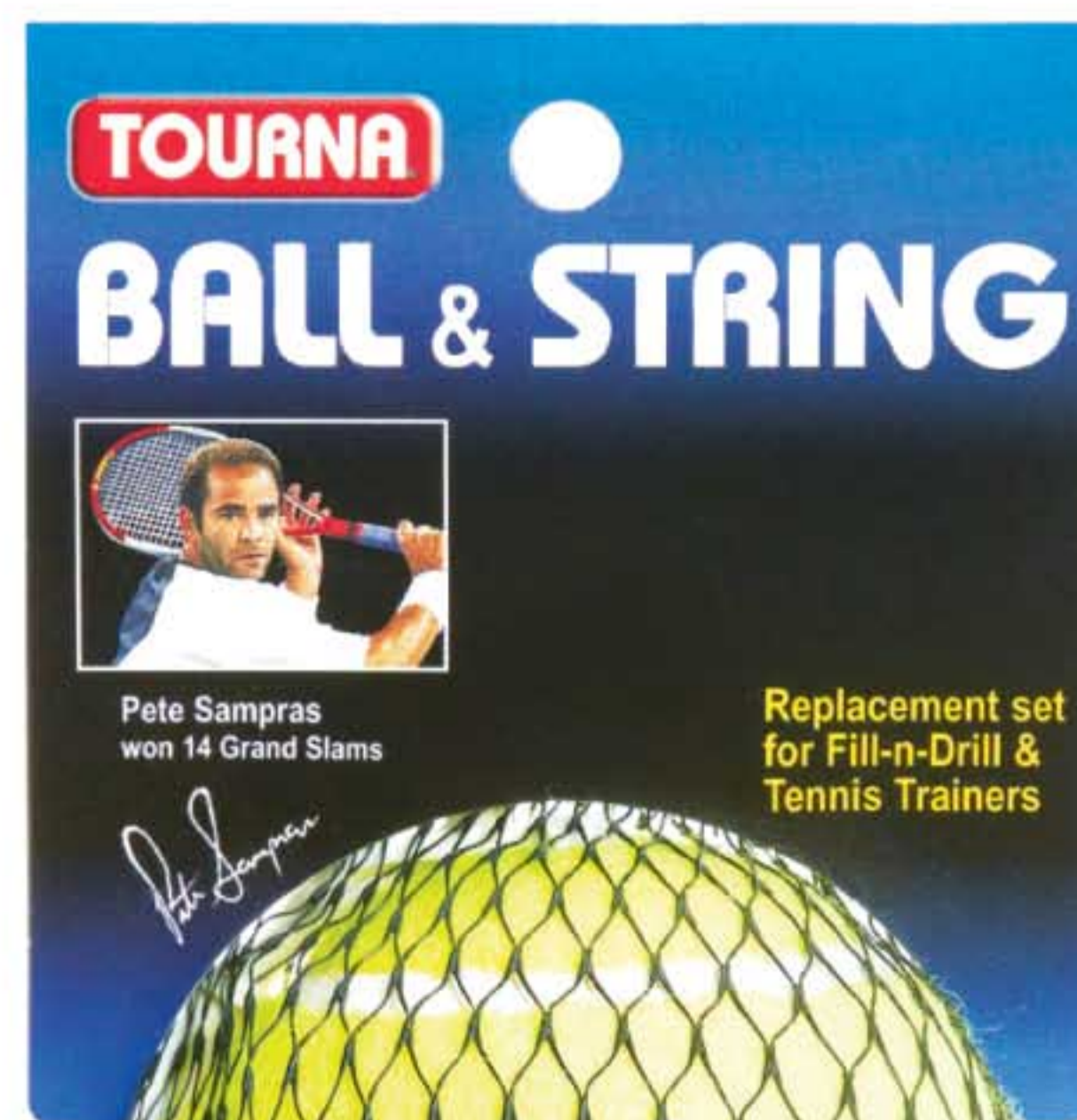
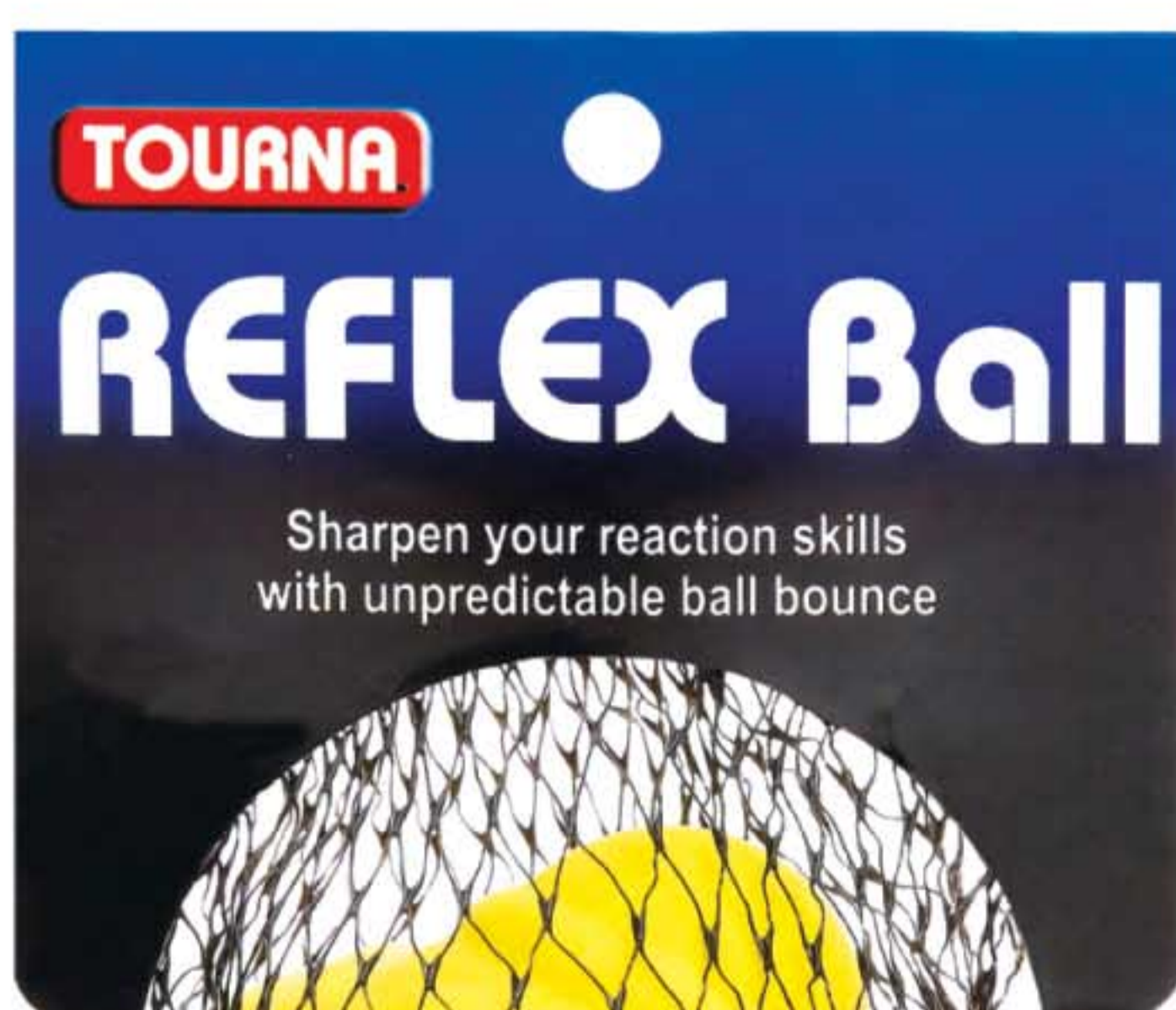

Pete Sampras Ball & String

Replacement parts for Tennis Trainers. Ball and string cord will wear out with practice. You need to stock this replacement part.

- # TT-BS Ball & String replacement
- # TT-S String replacement

NEVER DEAD Tennis Balls

These tennis balls never go flat. Ideal for practice and ball throwing machines. The bounce is true and always the same. Learning tennis is difficult enough without having to practice with dead balls that bounce erratically.



PMB - 12 - holds 12 balls

- 3 Pack - # EPTB - 3
- 12 Bag - # PMB - 12
- 18 Bag - # EPTB-18
- 48 Ball Bucket - # EPTB-48
- 45 Ball Pouch - # EPTB-45
- 50 Carry Pouch - # EPTB-50
- 60 Mesh Pack - # EPTB-60



EPTB - 12 - bulk 12 balls

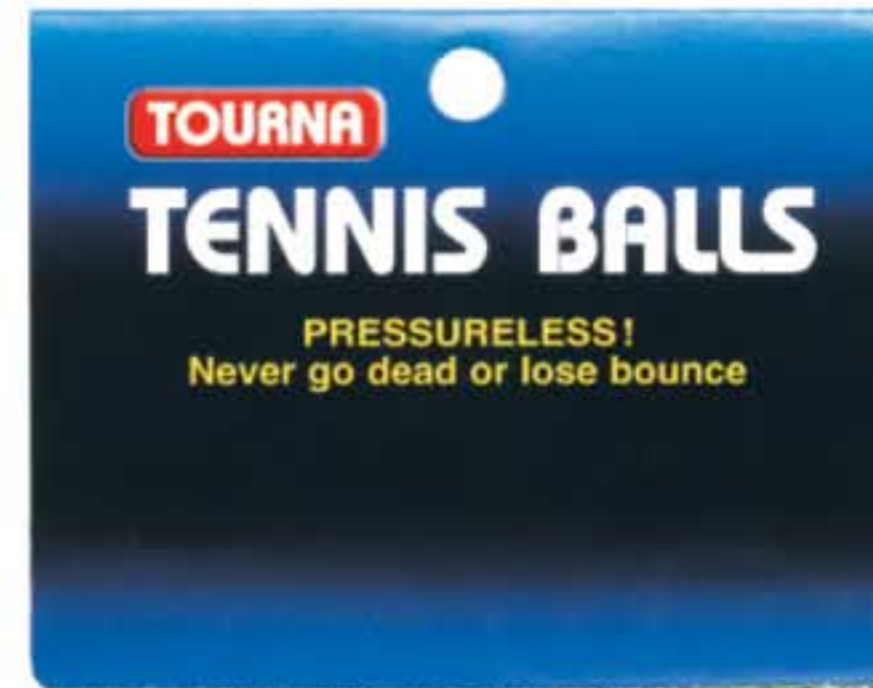

EPTB - 3 - retail pack of 3 balls

Patent # D668,947S



EPTB - 18 - holds 18 balls



EPTB - 45 - holds 45 balls



EPTB - 48 - holds 48 balls



EPTB - 60 - holds 60 balls



EPTB - 50 - holds 50 balls



All USTA and ITF sanctioned tennis tournaments for kids 10 and under are required to be played using a new combination of lighter and lower bouncing tennis balls and smaller tennis courts. Scaling tennis to child's size allows them to rally and learn to play the game quicker. See page 36 for Court dimensions.

Go to: www.USTA.com/OnCourtTraining for complete program details.



Tourna brand balls meet ITF and USTA 10U specifications. Reduced bounce and slower than standard ball for safer learning and children skill building.



Stage 1 Green Dot

- Ages 11+ plus years
- 25% reduced speed
- Final transition
- Tennis ball size
- Full court



Stage 2 Orange

- Ages 9 to 10 years
- 50% reduced speed
- Tennis ball size
- 60 ft. court



Stage 3 Red

- Ages 8 and under years
- 75% reduced speed
- 15% larger than regular tennis ball
- 36 ft. court

Pressurized Green Dot Tennis Balls

The Green Dot ball meets the official, Stage 1 specification of USTA, ITF Tennis 10s and ITF Tennis Xpress formats.

The Ball is regulation tennis ball size, has 25% lower bounce than standard balls and is **PRESSURIZED** for a lively bounce.

- # KIDS-G-P-3-4 4/cs (3/pressurized can)
- # KIDS-G-P-3-12 ... 12 pack of cans
- # KIDS-G-P-12 12 balls in plastic bag
- # KIDS-G-P-18 18 / carry mesh bag
- # KIDS-G-P-50 50 / Tote bag
- # KIDS-G-P-60 60 / mesh bag



KIDS-G-P-18

KIDS-G-P-3



KIDS-G-P-50



KIDS-G-P-12



KIDS-G-P-60

Stage 2 - Orange Dot Tennis Balls

Stage 2 ORANGE DOT

- # KIDS-2-3 3 pack
- # KIDS-2 12 pack
- # KIDS-2-18 18 pack
- # KIDS-2-35 50 Tote pack
- # KIDS-2-60 60 pack



Patent D668,947S

KIDS-2-3



KIDS-2-18



KIDS-2



KIDS-2-50 Tote

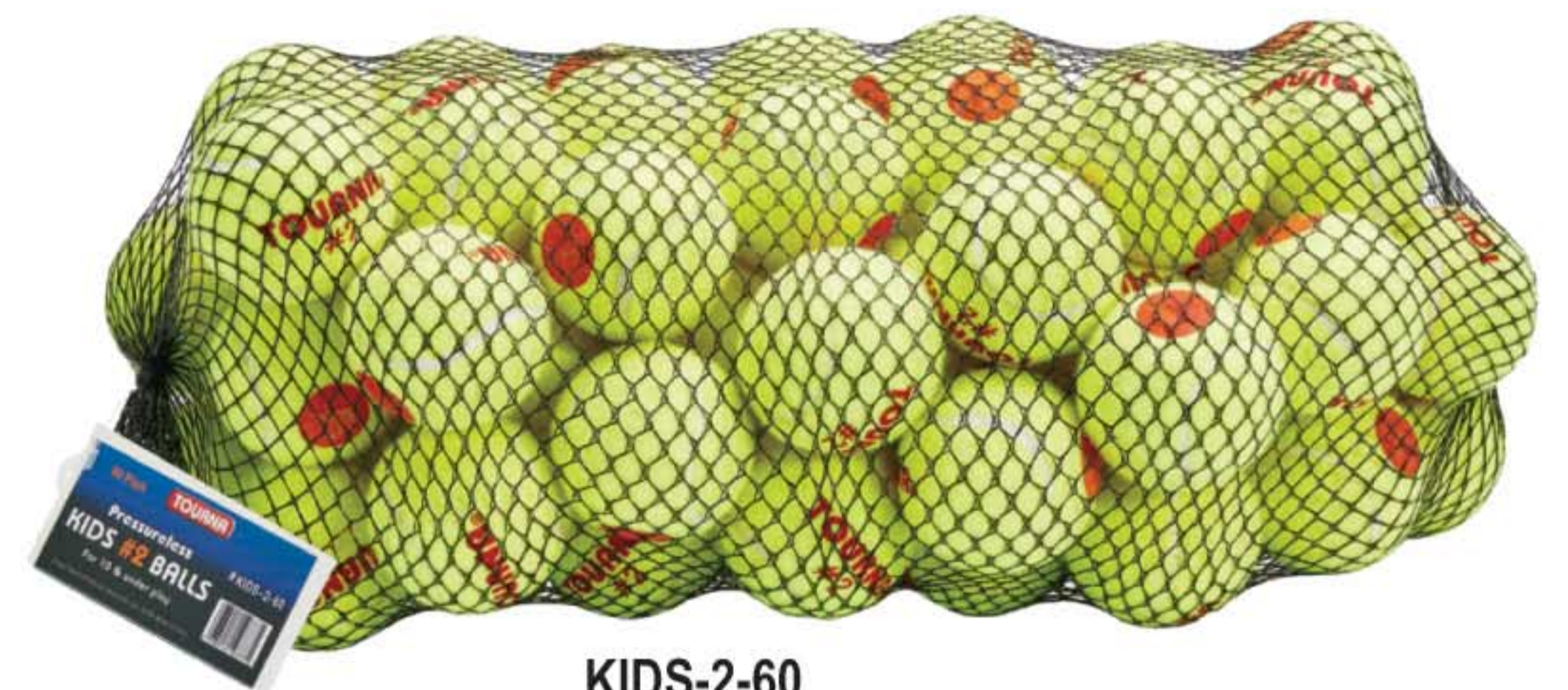

KIDS-2-60

Stage 3 - Red Dot Tennis Balls

Stage 3 RED

- # KIDS-3-3 3 pack
- # KIDS-3 12 pack
- # KIDS-3-18 18 pack
- # KIDS-3-35 35 pack
- # KIDS-3-60 60 pack

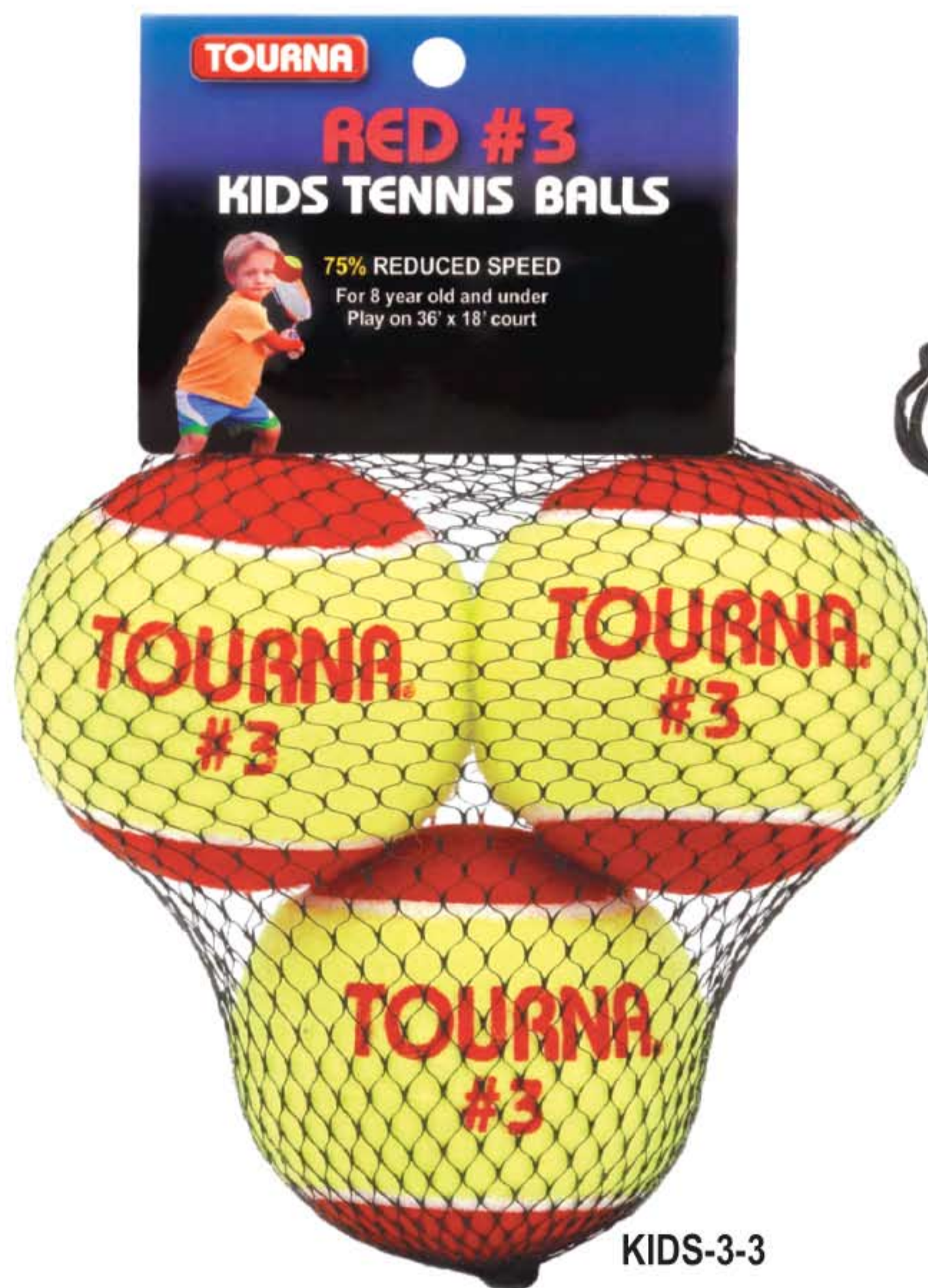

KIDS-3-3



KIDS-3-18



KIDS-3



KIDS-3-35 Tote

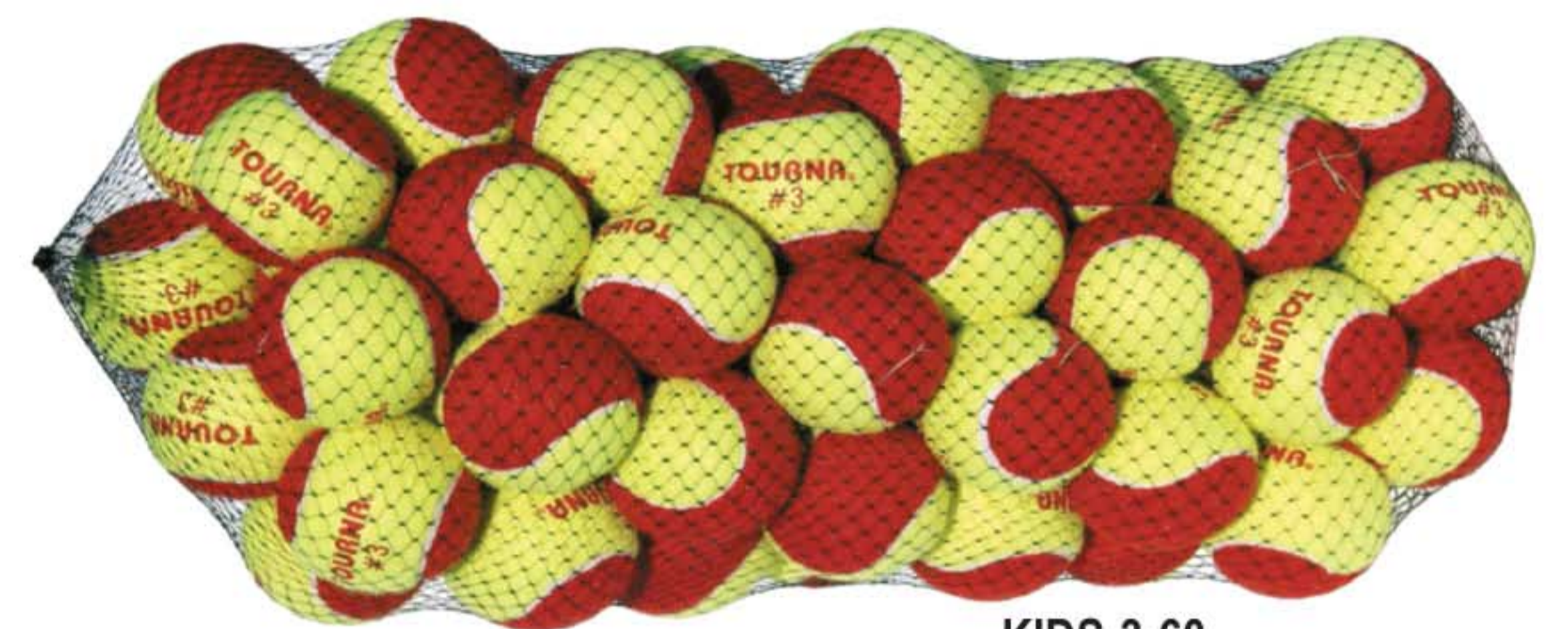

KIDS-3-60

Foam Balls

Foam balls made of foam. They are a great teaching aid for beginners. They simulate an actual tennis ball bounce. No one gets hurt with these foam balls. Practice inside the home against any wall (will not damage walls). Great during inclement weather.

- # TPB-1 (1 pack)
- # TPB-3 (3 pack)
- # TPB-12 (12 bulk)

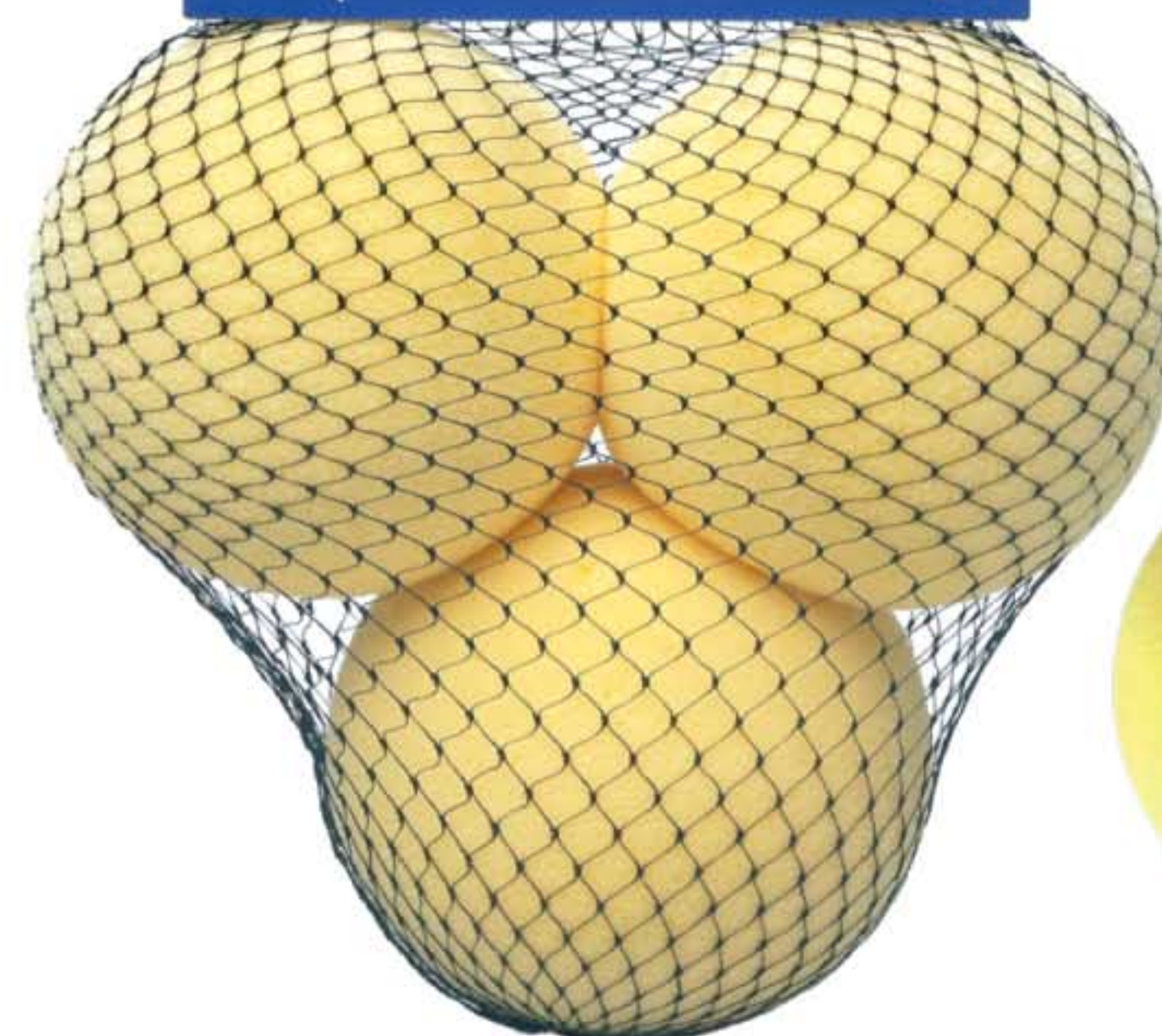
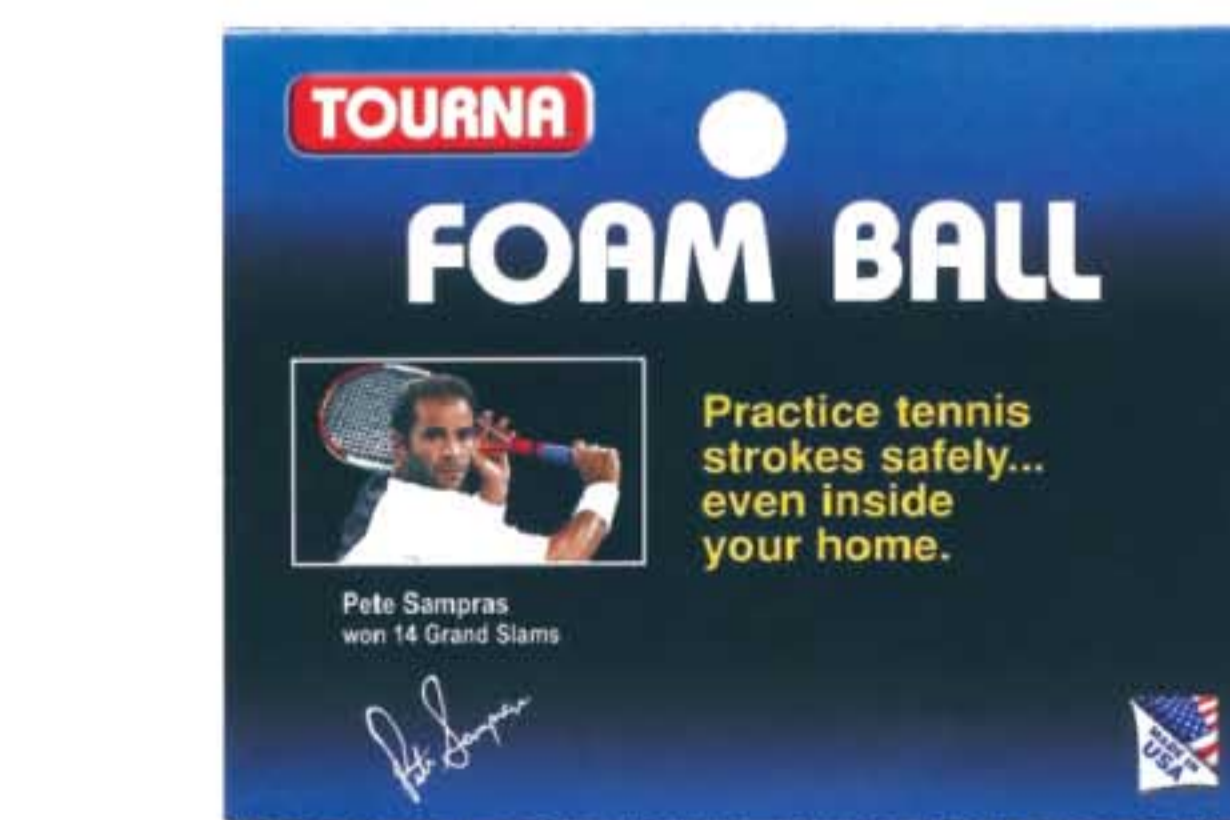
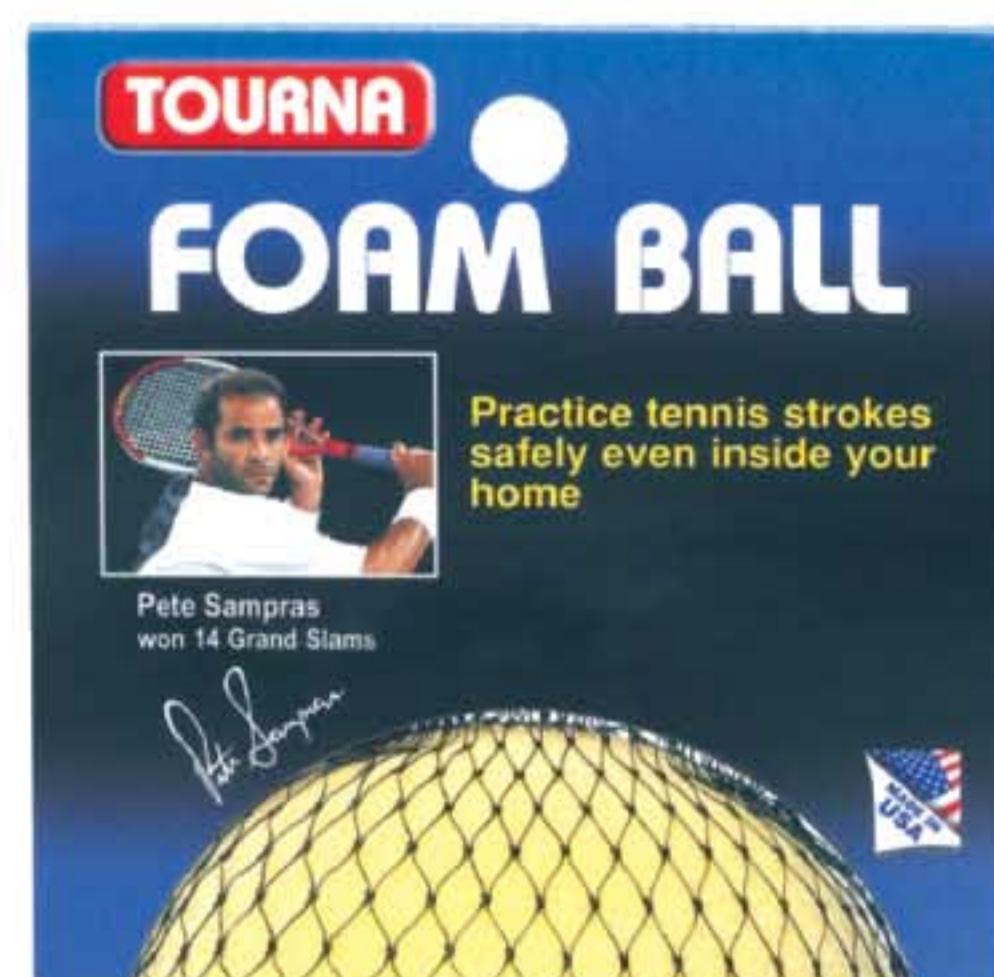

10 and under Tennis Court Dimensions

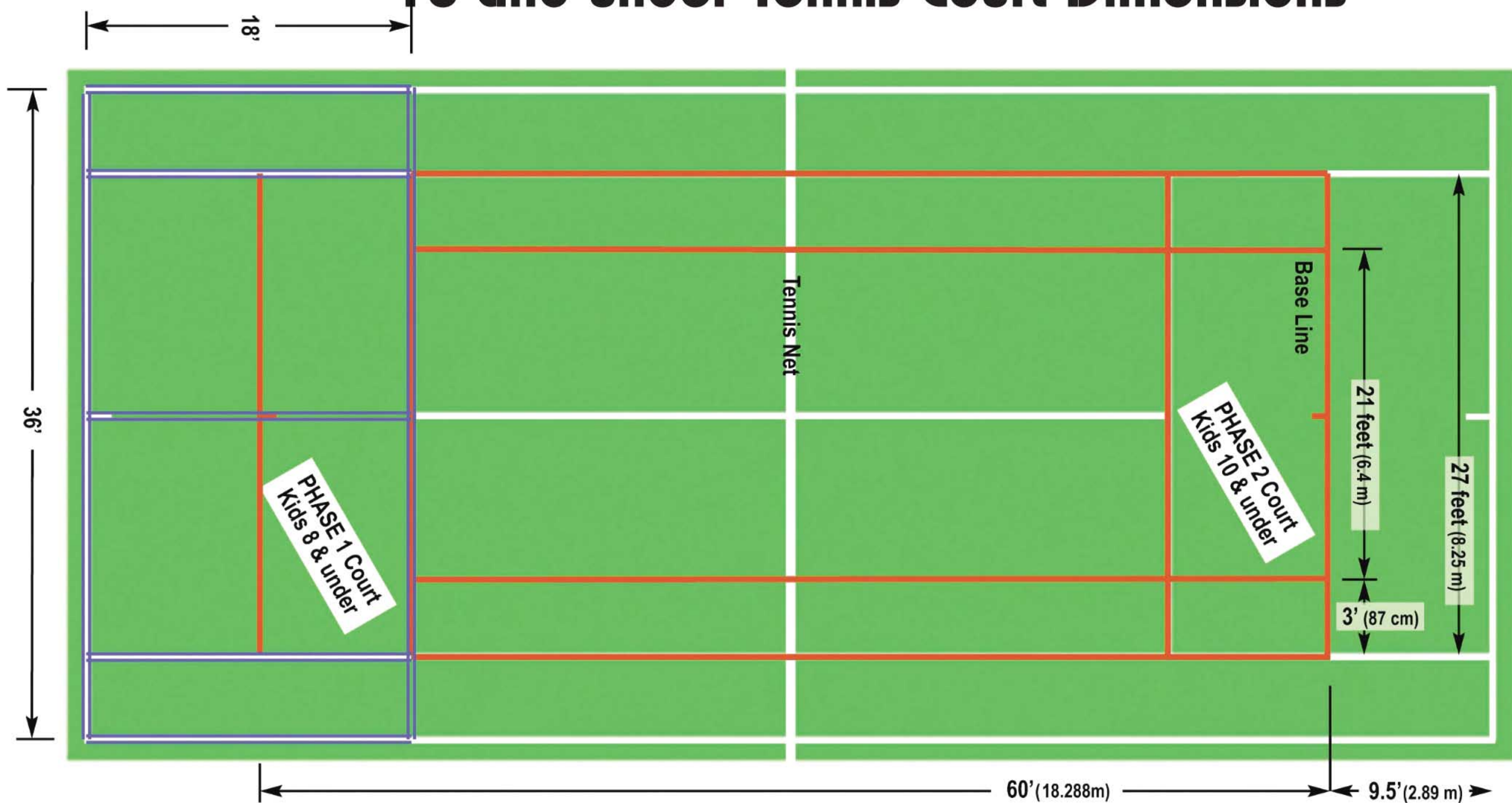

10 & Under Portable Tennis Nets



10' and 18' official size tennis nets for 10 & under tennis court.
Portable and lightweight for quick and easy set up.

- Handy carrying case with shoulder strap
- Black steel frame base
- Adjustable sleeve net - 33" high
- Velcro base straps

KNET-10 (Ten foot net)

KIDS-18 (18 foot net)

Kids Tenn Tube Ball Pick up



It makes ball pick up fun for kids. Teaching pros love them. Kids run on the court picking up balls and return them to pro's baskets. Made of durable, lightweight plastic. The end of tube has a patented fence or a cart hook. Elastic band secures the balls so they stay in tube for transporting. Picks up to 20 balls.

KTUB-W Picks up 1,2,3 stage Kids ball



Bottom view shows the unique rubber prongs that allow different size balls to be picked up.



TOURNA

Ballport® Ball Pick-Up

Ballport® is not just another ball pick-up. It is made of durable poly-propylene so it NEVER rusts, or peels paint, or welds break. Ballport is patented and unique.

Patented features:

- Bars roll at bottom so balls easily lift into basket instead of being forced in
- Two sliding bars at top provide for quick closure and transport
- Handles lock in place in up and down position with built-in locking mechanisms
- Unique design assembles quickly
- Ships in 2" x 25" x 14" box. Box takes little space. Freight is low compared to fully assembled unit



Lightweight

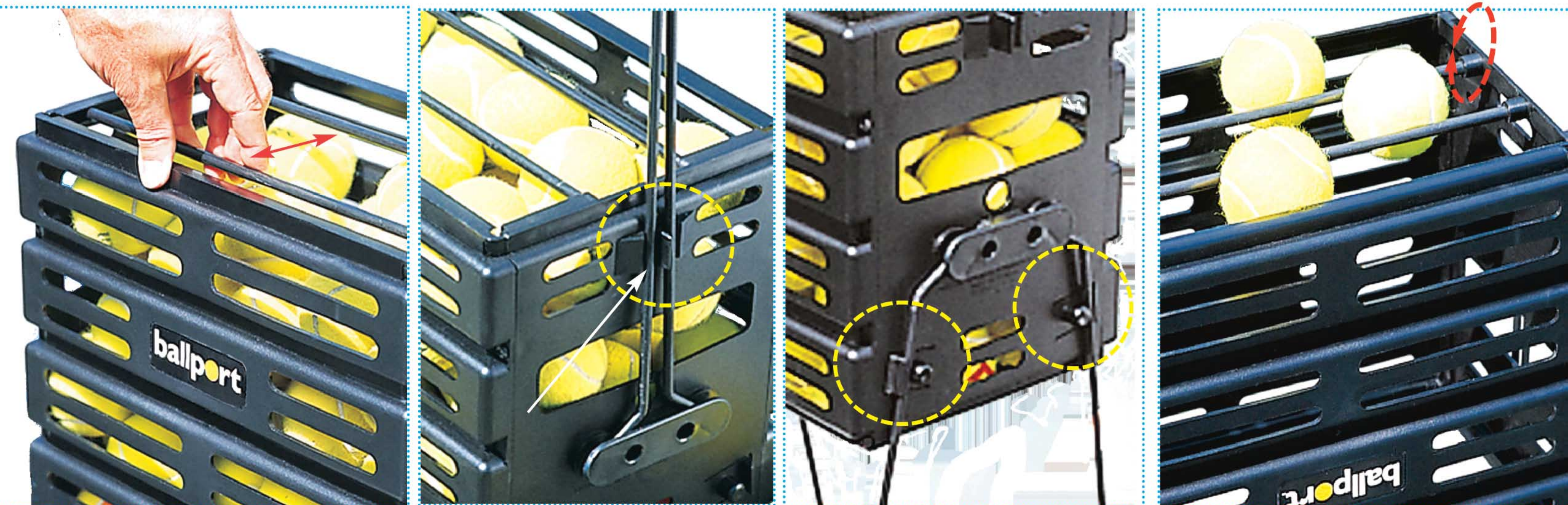

Sliding bars at top for closure

Handles lock in down position

Handles lock when in up position

Bottom bars turn thus rolling the balls into Ballport

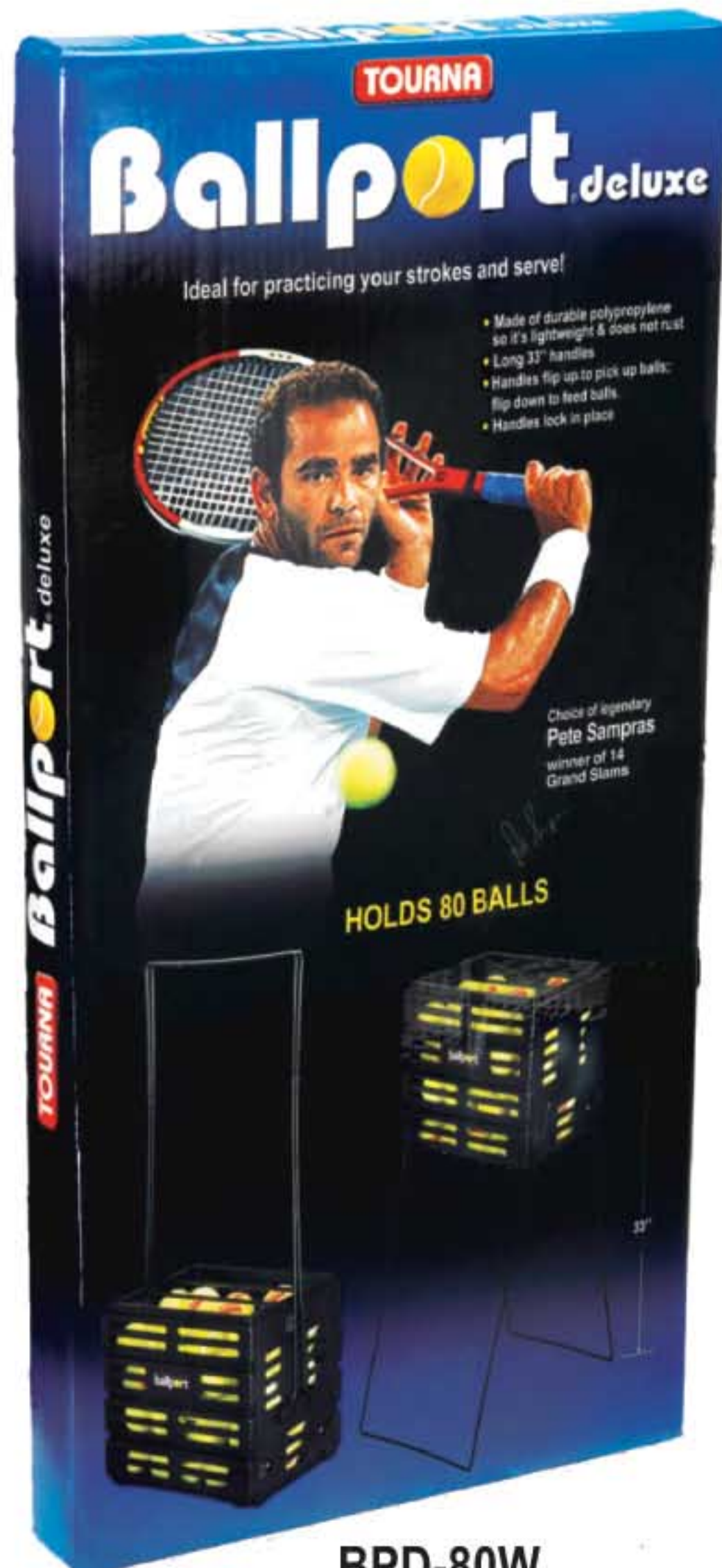

BPD-80W



ABPD-80W



BPD-80W-B



BPD-80W-R

COLORS
NEW!

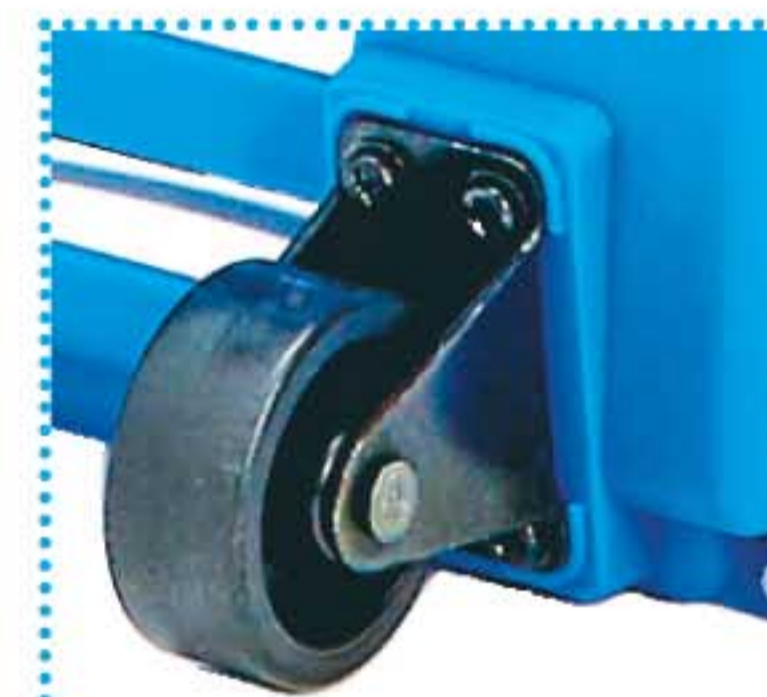

Wheels for easier transport



Deluxe Ballport with wheels

Holds 80 balls

Handles are extra long at 33" It is designed to affix wheels for easier ball pick-up.

- # BPD-80W - with wheels 1/cs
- # ABPD-80W - assembled + wheels 3/cs
- # BPD-RW - spare wheels 2/cs

Pete Sampras

TOURNA

Ballport® Ball Pick-Up

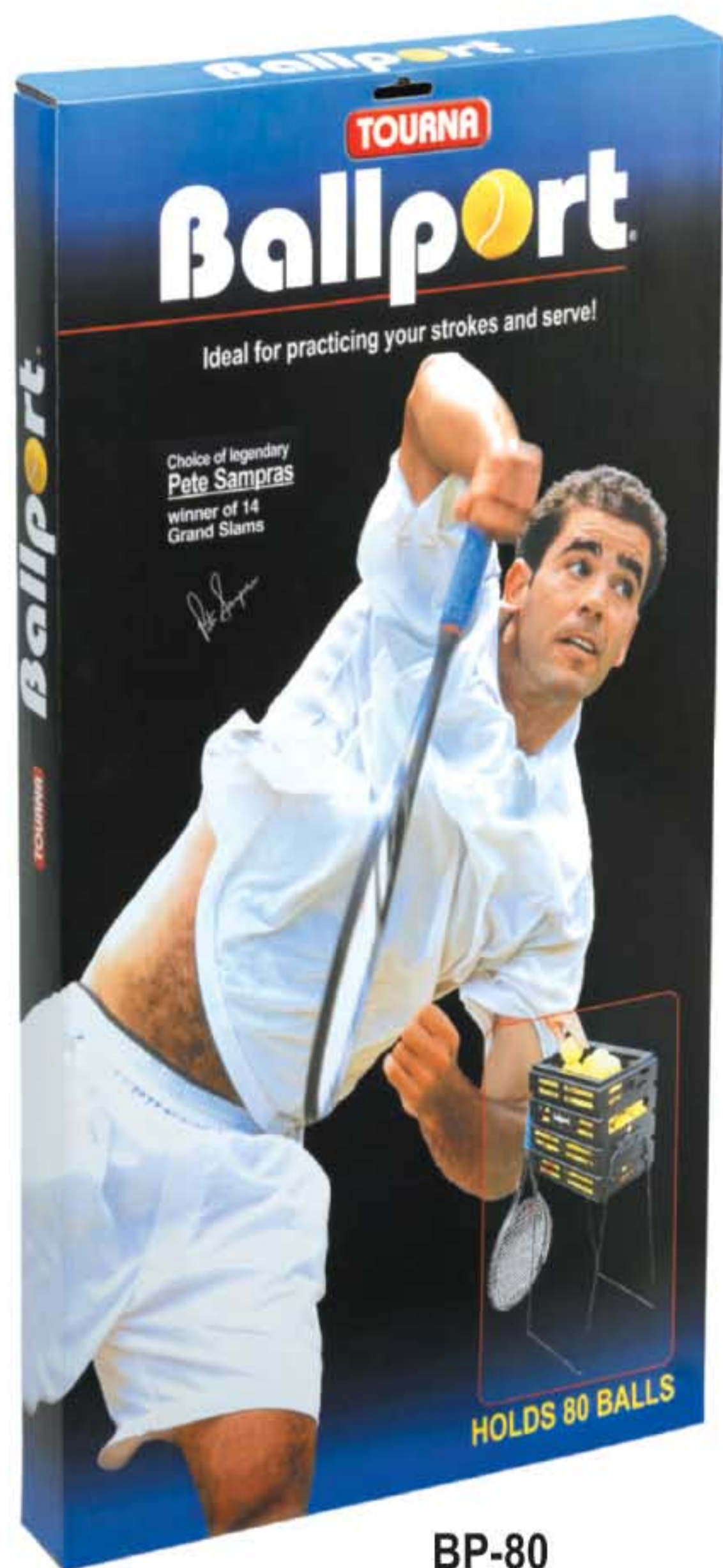

BP-80

NEW! COLORS



ABP-80-R



ABP-80-B



ABP-80

Ballport - 80

Holds 80 balls

- # BP-80 Black - display box 1/cs
- # ABP-80 Black assembled 3/cs
- # BP-80-R Red - display box 1/cs
- # BP-80-B Blue - display box 1/cs

Pete Sampras

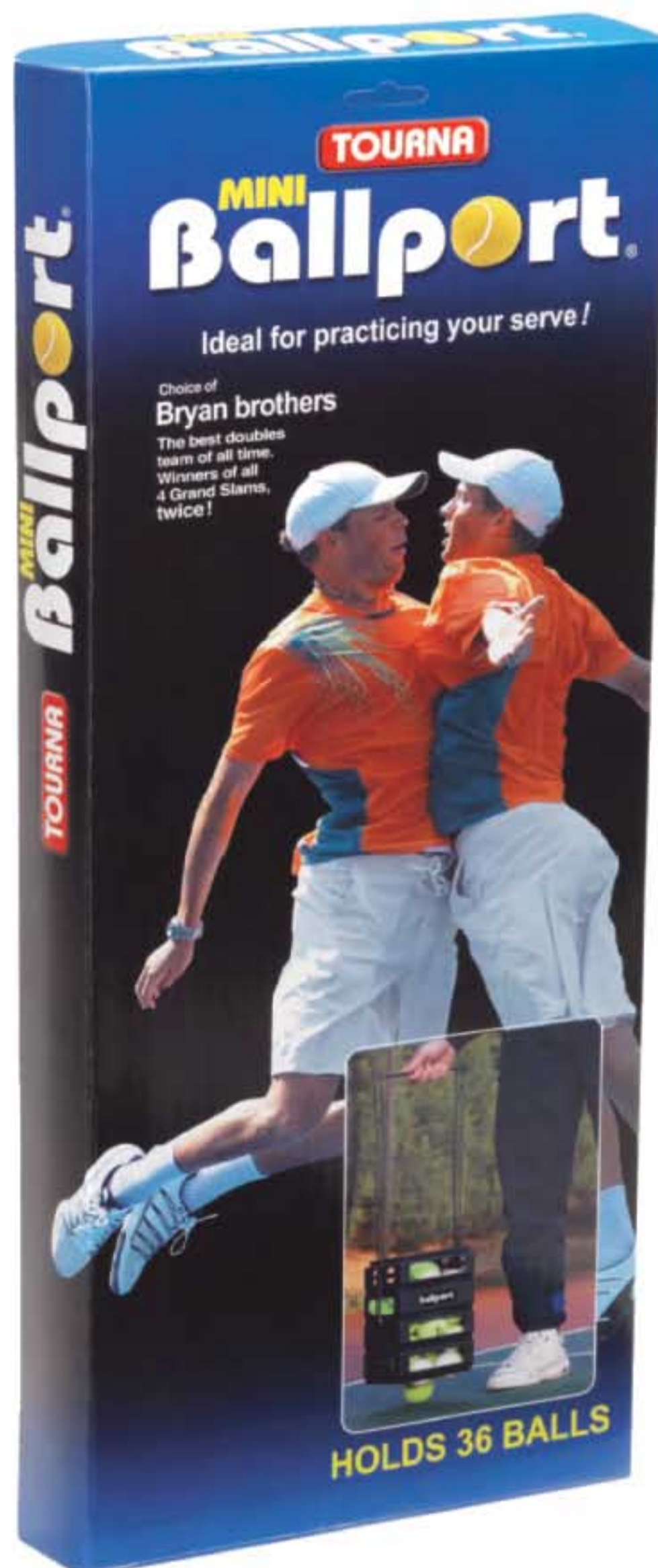

BP-M



ABP-M-B



ABP-M-R



ABP-M

Mini Ballport

Holds 36 balls

- # BP-M Black - display box 1/cs
- # BP-M-R Red - display box 1/cs
- # BP-M-B Blue - display box 1/cs
- # ABP-M-6 Black Assembled 6/cs
- # ABP-M-2 Black Assembled 2/cs

Bob Bryne M Paul



Knock down wire Ballport in a box. Easy assembly,

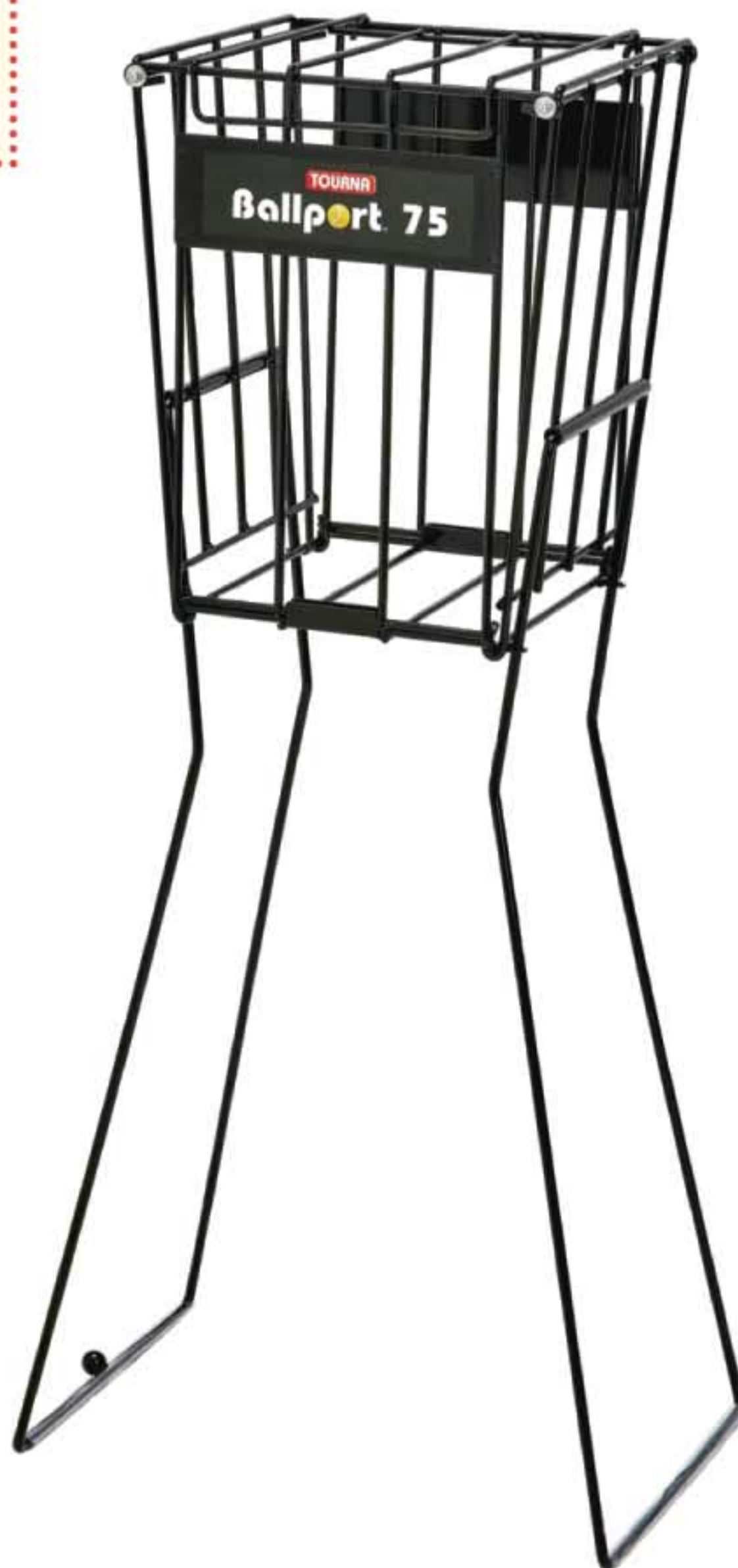
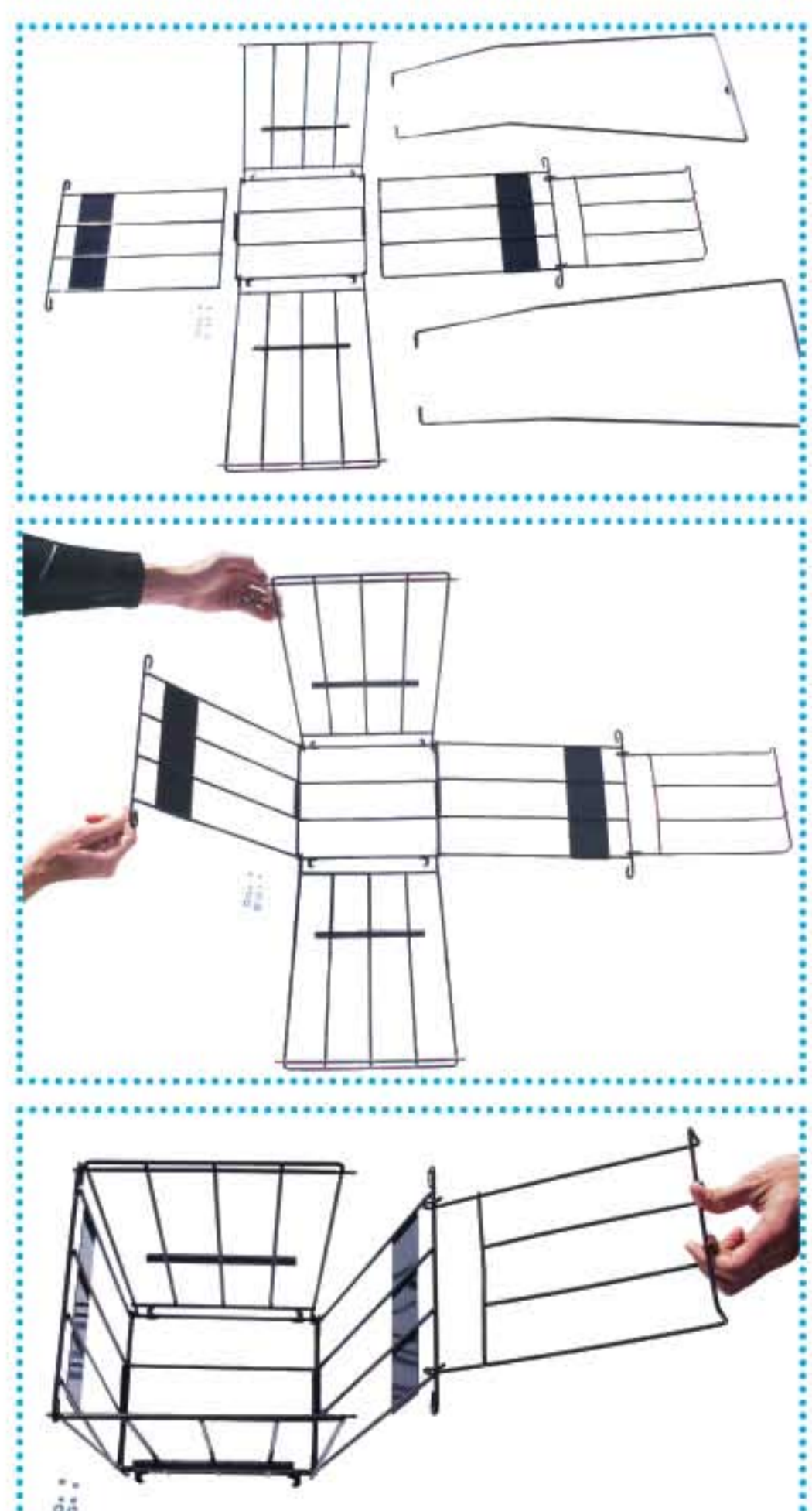

WIRE - BALLPORT 75

Ballport 75 ball pick up is an all steel, sturdy wire construction that comes unassembled in a display box. The unit assembles quickly with 4 fasteners. It holds 75 tennis balls. Front box panel displays Bryan brothers endorsement.

Box takes up very little space:
3" x 11" x 27"

Saves on shipping costs and shelf space.

BP-75

Bob Bryne M Paul

Classic Ballport® (70)

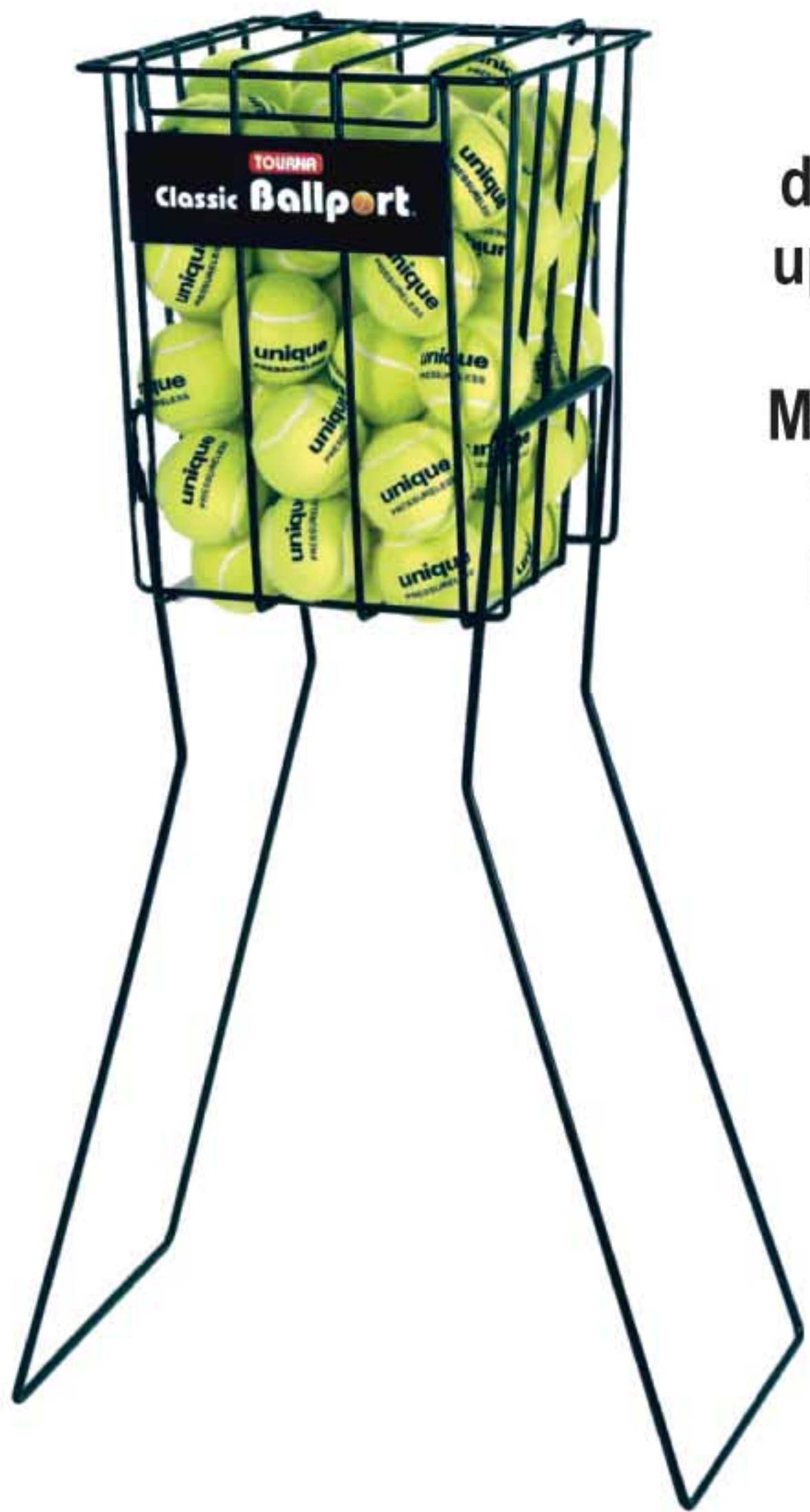

Classic wire design that picks up and dispenses up to 70 balls. Made of steel wire with a weather resistant black coating. Attached lid secures balls in basket.

BPC-70-1
BPC-70-6 (6 / box)



NEW!

Classic Ballport 120

Made of steel wire with a weather resistant coating.

Designed to hold 120 balls for extended practice. It holds plenty of balls for practicing serves, and ground strokes.

BPC-120-1



BALLPORT PRO

Heavy duty wire construction for long lasting use. Designed with tennis teaching pro in mind.

Ballport PRO holds up to 85 balls and Ballport PRO-50 holds 50 balls. Great ball pick-up companion with ball carts that hold hundreds of tennis balls. Handle is removable so it ships in a smaller box.

BP-PRO-1 (1/box); # BP-PRO-1-6 (6/box)
BP-PRO-50 (1/box); # BP-PRO-50-6 (6/box)



BP-PRO-1

Holds 80 balls



Shipped with handle unassembled to save on freight costs



Holds 50 balls

BP-PRO-50



Band prevents balls from falling out

Hooks on fence



46"

Tenn - Tube®

The Original, patented ball pick up tube. It makes ball pick up fun for kids. Teaching pros love them. Kids run on the court picking up balls and return them to pro's baskets.

Made of durable, lightweight plastic. The end of tube has a patented fence / cart hook. Elastic band secures the balls so they stay in tube for transporting. Picks up to 20 balls.

In popular colors:
Lime Yellow, Blue, Red,
Orange, and Clear.

TUB-21-B Blue
TUB-21-R Red
TUB-21-Y Yellow
TUB-21-O Orange
TUB-21-C Clear



NEW improved bottom - made thicker & wider to last longer

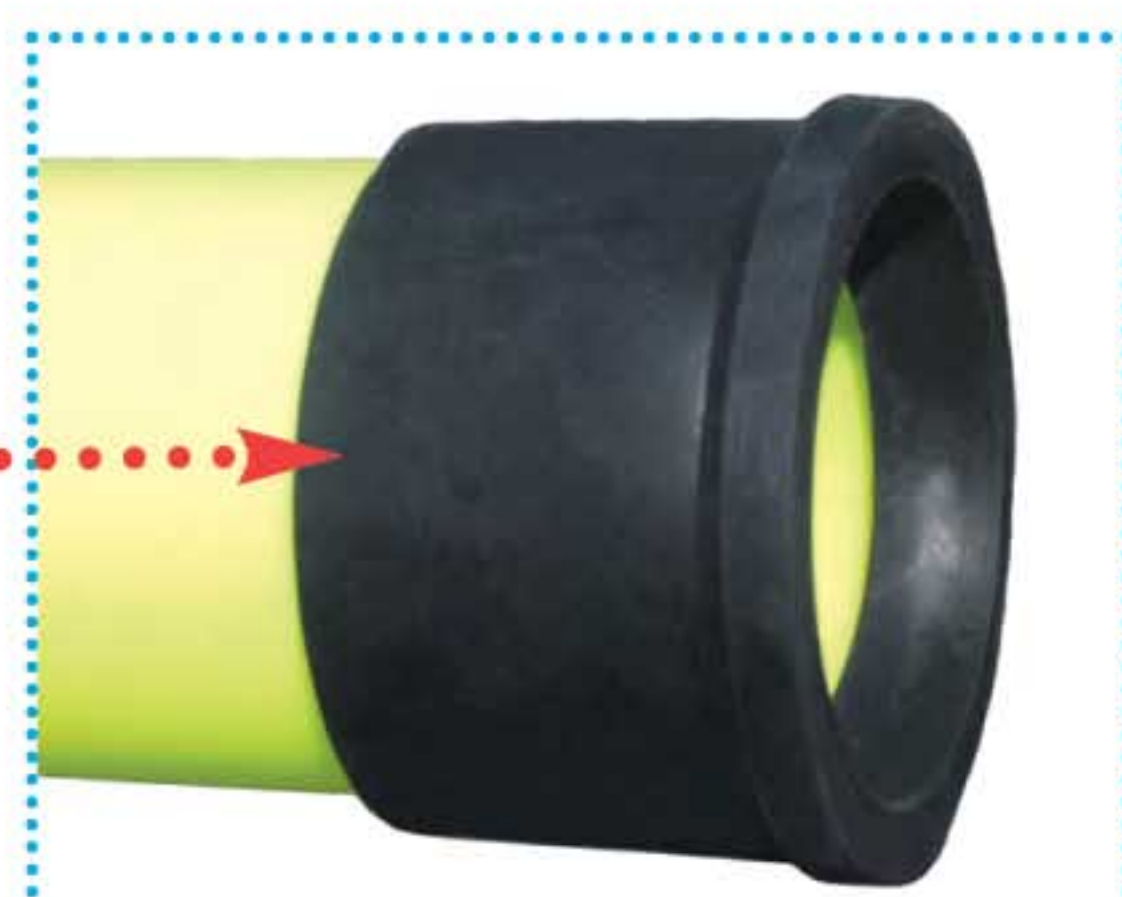

DRY FEEL

TOURNA GRIP®



CHOICE OF CHAMPIONS

The LIGHT BLUE GRIP® that does not slip !

This is not just any other grip....**this is Tourna Grip**, the gold standard for tennis grips. No other grip has been able to match the incredible absorbency and performance of Tourna Grip....None! In fact, when play heats up and Tourna Grip becomes wet, unlike other grips, Tourna Grip actually becomes tackier to hold and thus will not slip.

Tourna Grip was invented and continues to be made in USA.
Pros, college and junior ranked players depend on Tourna Grip.

Over 75 million Tourna Grips sold since we invented it.
Unbeatable performance!

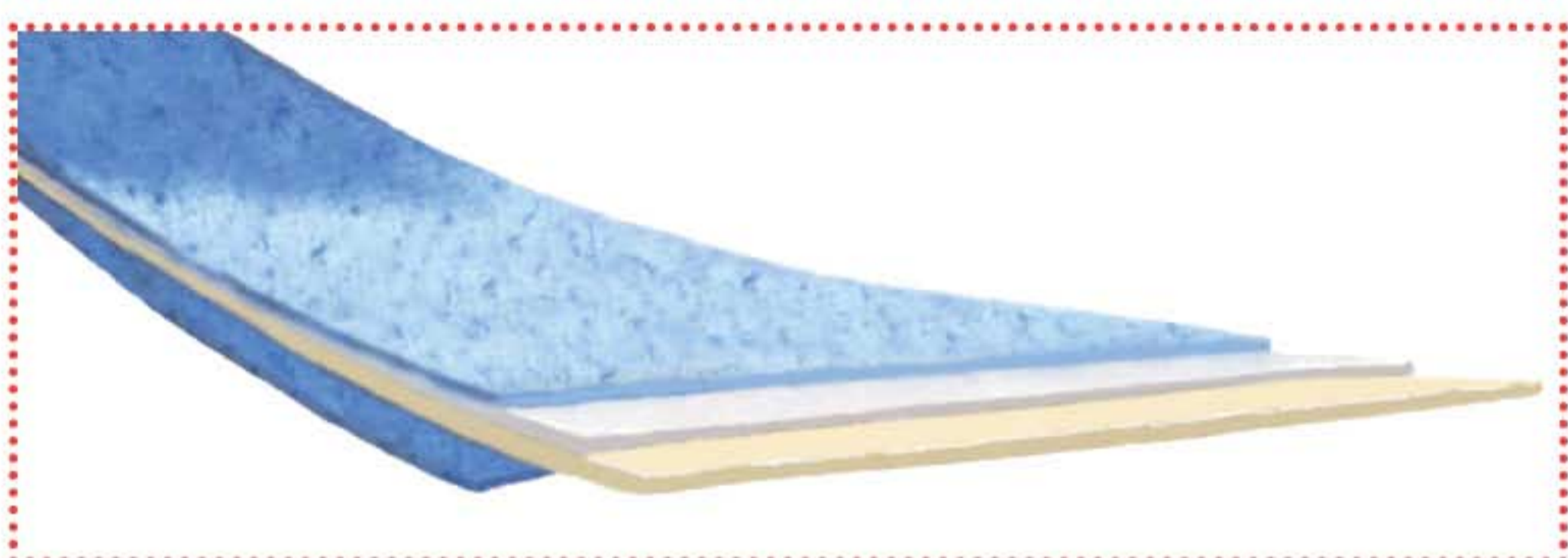

Tourna Grip is made with proprietary layers of materials



Tourna Grip absorbs up to 350% of its initial weight. It gets tackier when wet.



Easily wraps over grip.

Weekend tennis players don't carry 4 or more racquets to use during a match to replace the one when it's grip gets wet and starts to slip.

Tourna Grip will not slip the entire match.

Richard Gasquet

- Absorbs Moisture
- Players can use both sides of Tourna Grip

This is the original creation, a dry feel grip that really soaks up sweat. It is ideal for hot humid days. Tourna Grip becomes tacky when wet - unlike other grips which slip when wet. Its proprietary manufacturing process will never change. Tourna Grip simply outperforms any other grip on the market.

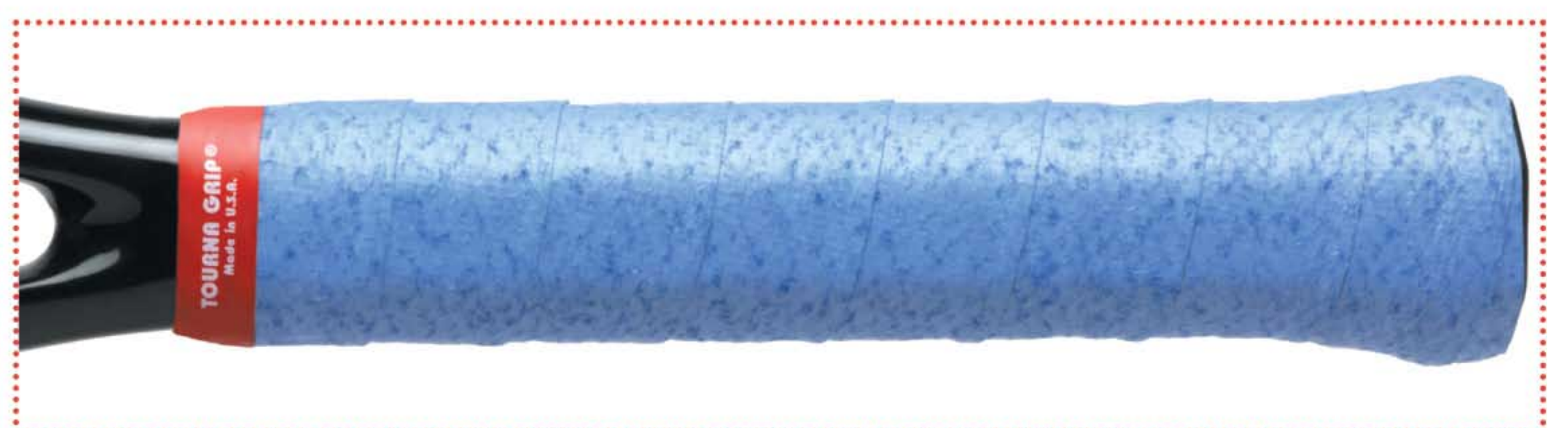



Ballport® 325 Teaching Cart

Designed for teaching pros. Holds up to 325 balls. Comes with **bottom tray**, wheel brakes, chrome plated legs, and durable wheels*. Basket is powder coated to last. Can be padlocked for storage. Weighs 39 lbs.

BP-325

* WHEELS ARE EASY TO REPLACE.
BPT-220-WHEEL - Call to order replacement set

Wheel brake



Ballport® 220 Travel Teaching Cart

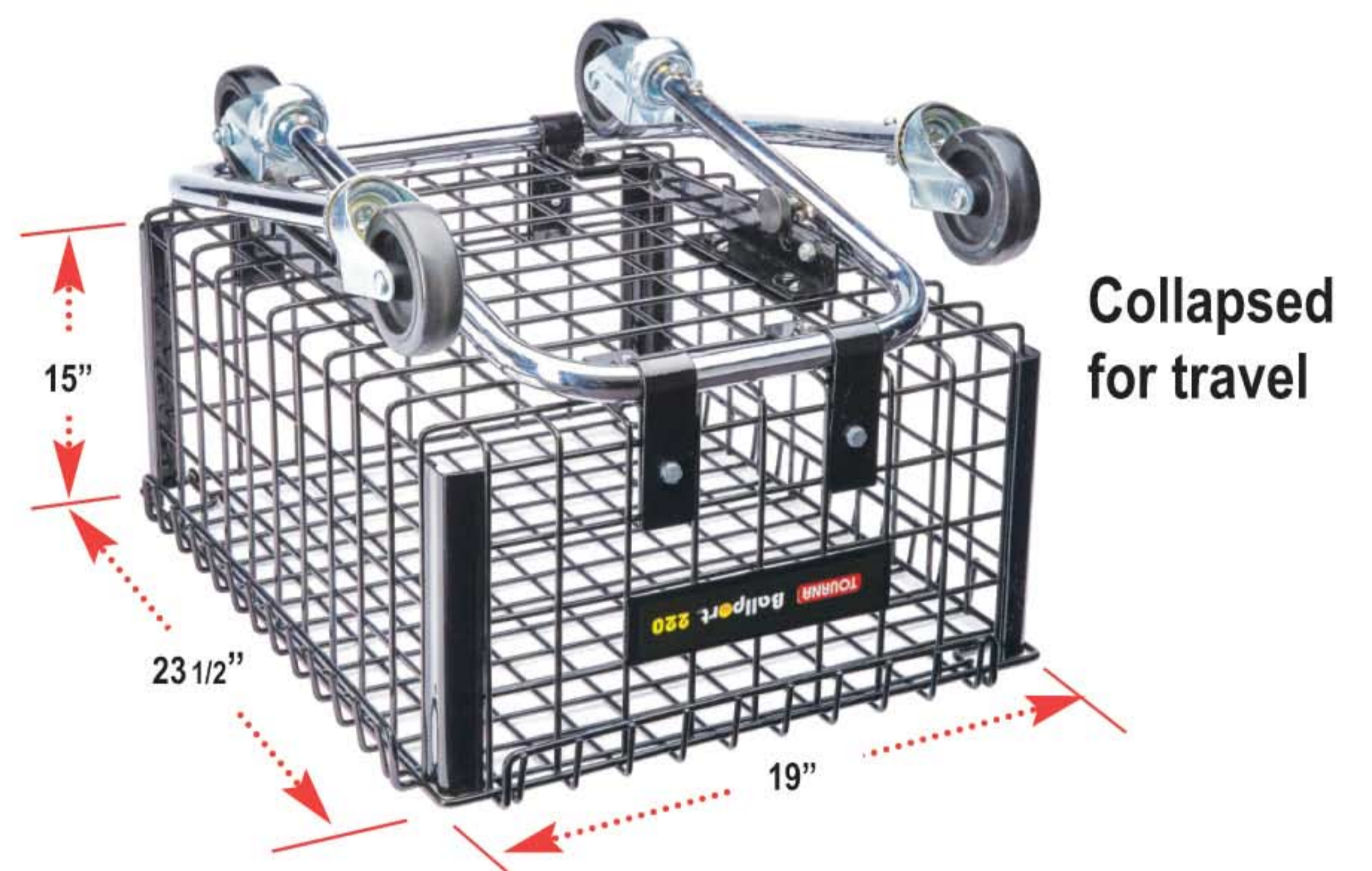

Teaching Cart Divider

Mesh construction. Velcro straps fasten Cart Divider to the cart sides. Fits all 325, 220 or similar carts.

BP-325-D 325 Travel Cart - 13" high
BPT-220-D 220 Travel Cart - 10" high



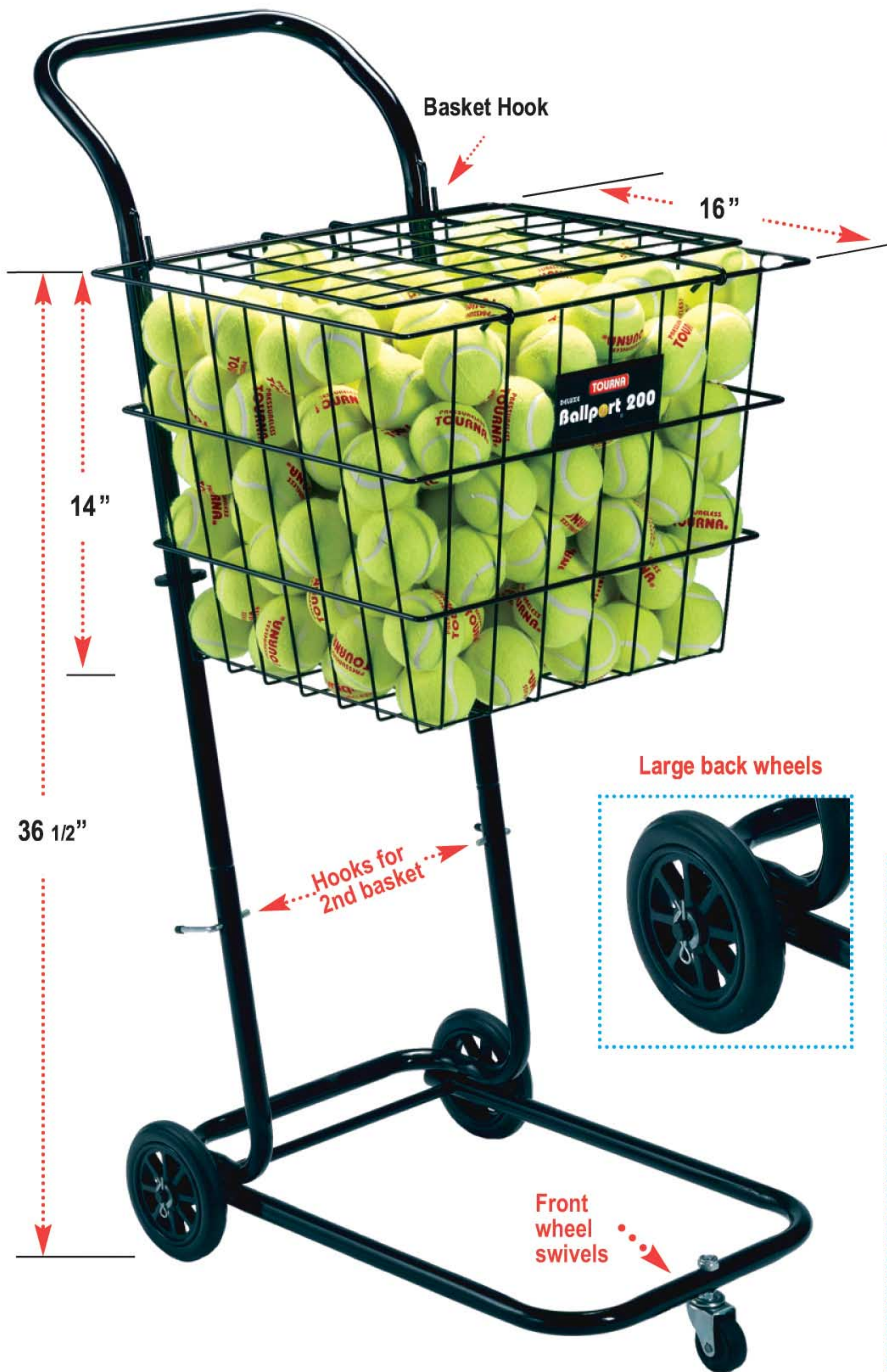

Ballport® 200 Deluxe Dolly Cart

Designed for the ultimate ease of transporting 200 balls. Large back wheels make it easy to traverse over steps. You will be amazed how easily the Dolly Cart maneuvers compared to other carts. It breaks down quickly and easily to fit in a car trunk. Lightweight.

- Additional front wheel
- Bigger rear wheels
- Heavy gauge closure top that can be padlocked
- Extra hook on bottom legs to hold another basket
- Baskets can interchange easily
- Extra basket sold separately

Order 1 or 2 extra baskets depending on your use.

- # BPD-200
- # BPD-200-B Extra basket (with lid)



Ballport® 180 Folding Cart

It doesn't get any easier to transport over 180 tennis balls. The bag lifts from the Travel Cart which neatly folds for car transport. Velcro flaps secure bag to frame. Bag comes with mesh top that zips shut. Teaching Pros, parent teachers, and serious players love it.

- # BP-180
- # BP-180B Extra bag



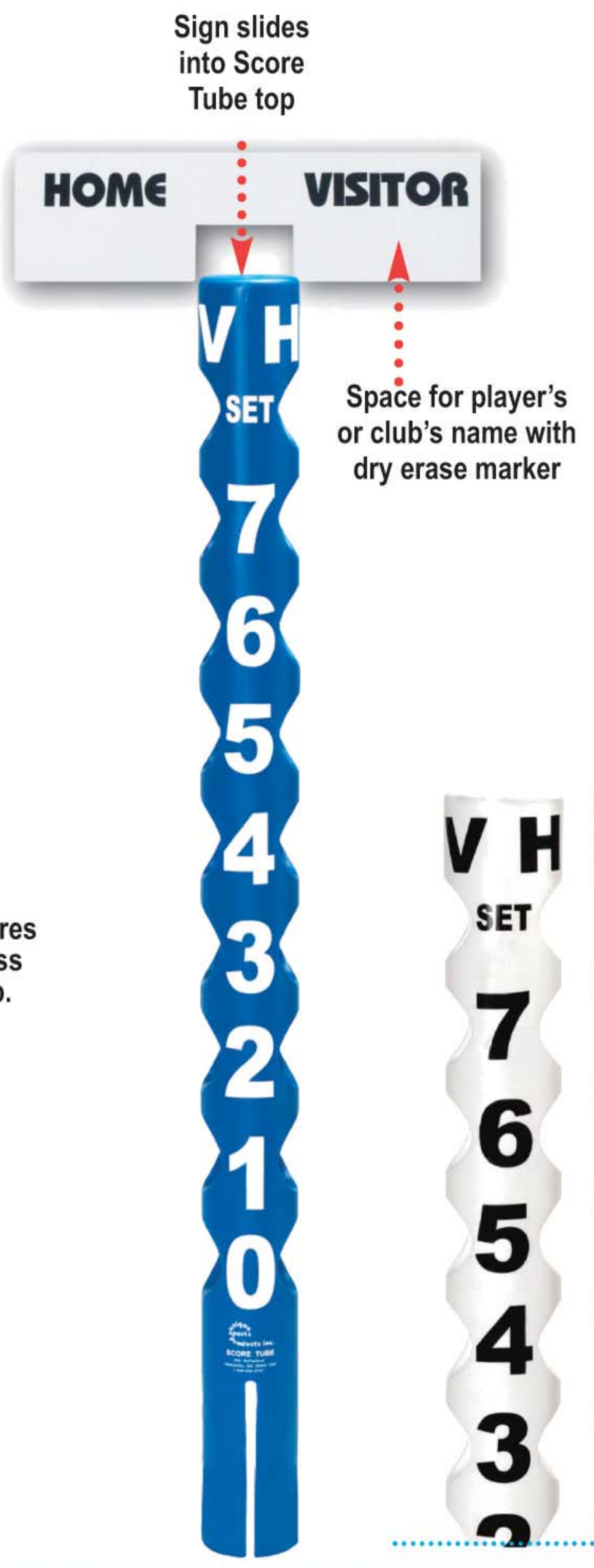

Score Tube ®

Patented tennis score keeper fits right over a round net post, attaches to net, or secures to fence. Installs quickly and easily. Stainless steel clamp is included to secure to post or net. Score Tube can also be hooked to a fence with supplied fence hook.

There are no moving parts. Tennis balls are used to keep score. The entire unit is sealed so rain and weather will cause no damage. There are no moving parts to rust or to vandalize. Graphics are coated with lacquer for longer life.

Add a fresh new look to your courts at the fraction of the cost of other score keepers.

US Patent # 6,578,513

- # SC-W White ; # SC-BK Black
- # SC-B Blue ; # SC-G Green
- # SC-SI Sign (Home-Visitor)

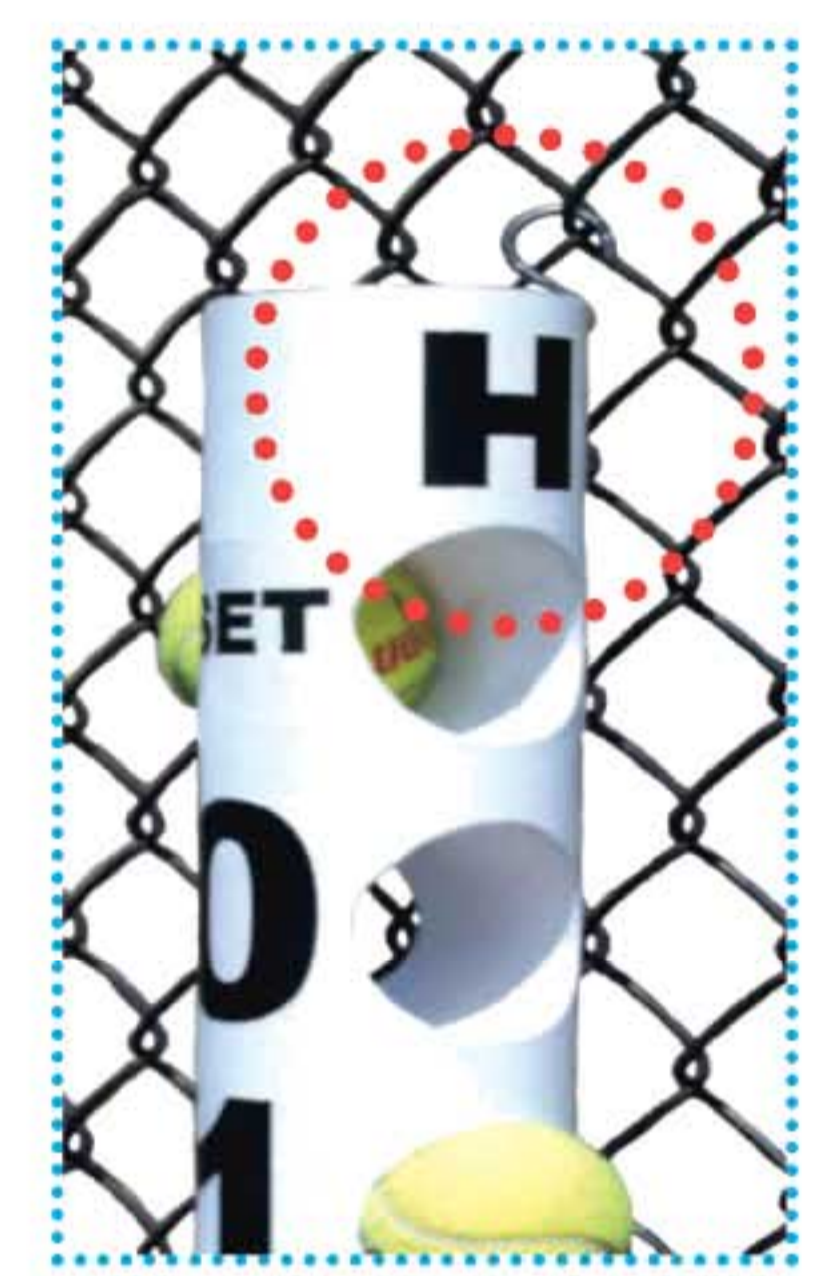
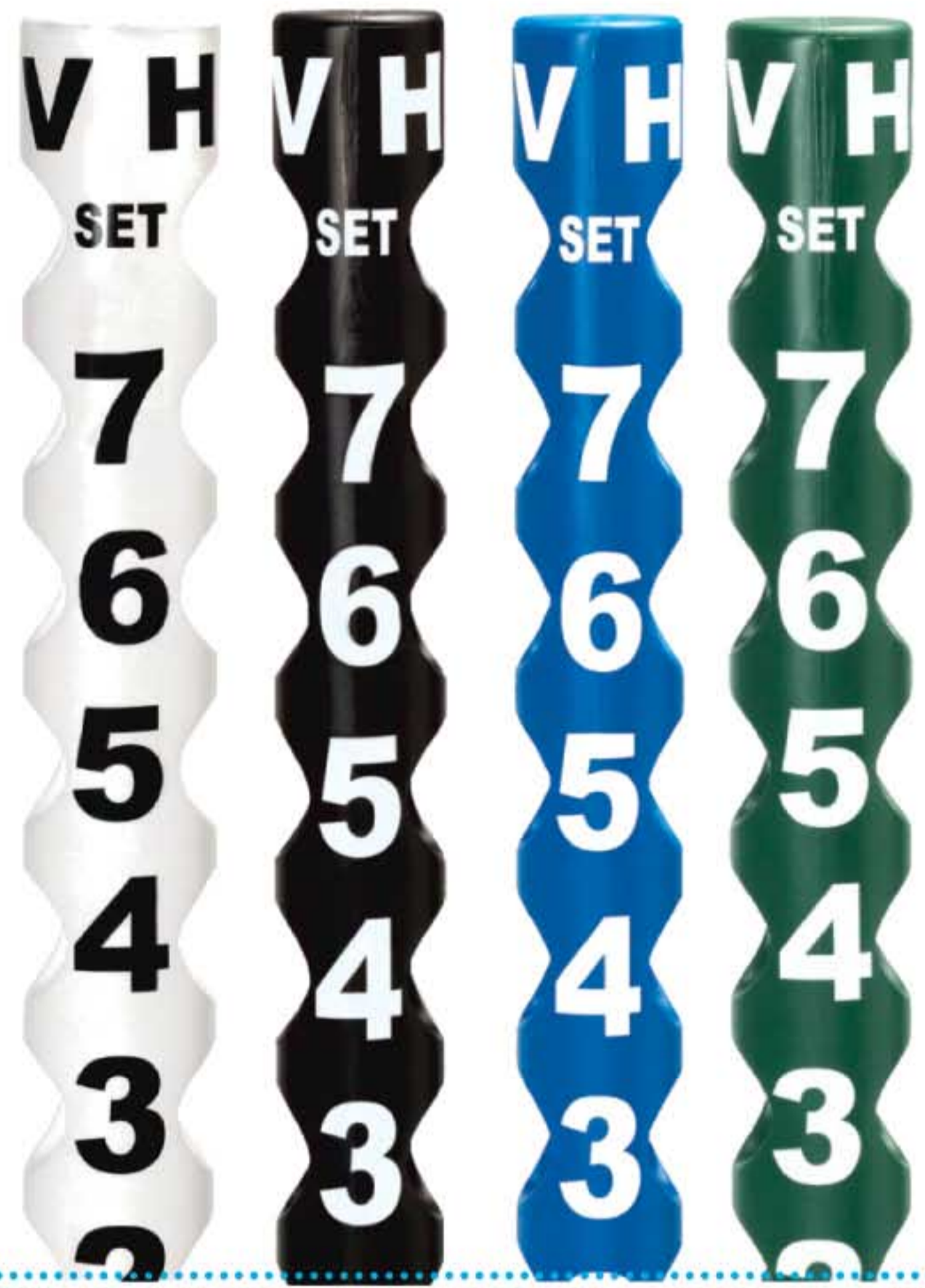

Designed to also hang on fence enclosed with hook

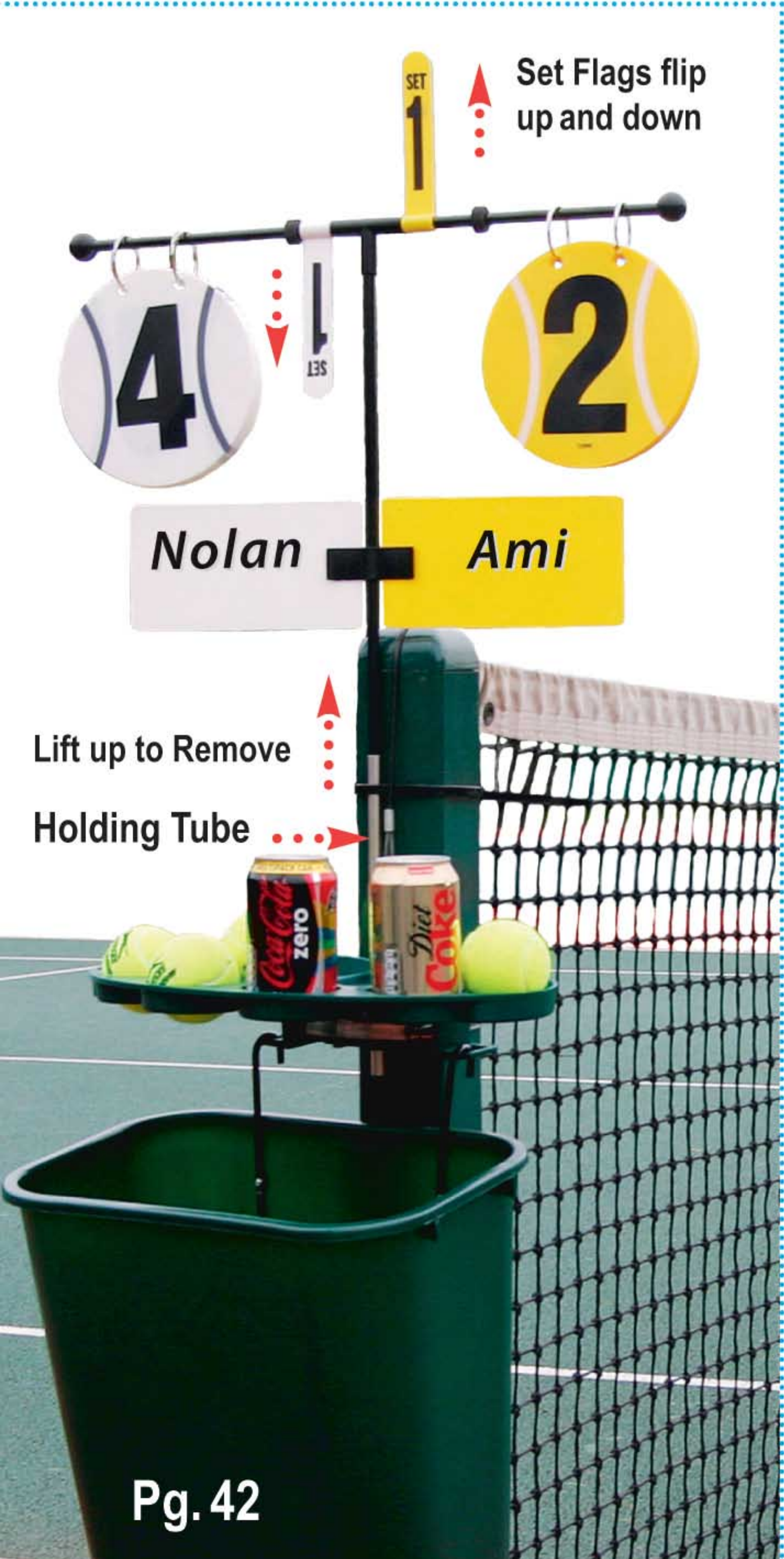

Score Keeper

Score Keeper parts are made with durable PVC plastic...no parts to rust. Installs quickly to tennis net post with supplied stainless steel clamp.

The top portion lifts from the stainless steel tube for storage in the club house. The flip cards are made to look like a tennis ball. The flip cards go from # 0 to # 9.

Set flags rotate up and down. Two name plates are included for players names to be written and erased with a dry erase marker.

US Patent # 418,431

- # SCO -1
- # SCO -N (replacement numbers 1-9)



Portable Net Scorer



Portable Net Scorer that slides over top of tennis net header. Simply push down over net. Position outside of service line. Flip cards go from # 1 to # 9.

Patented! Made of stainless steel wire construction. Comes with carrying case. Very light.

SCO-3 patent pending

Portable Net Score Keeper



Portable score keeper that fits in travel tennis bag. Fits directly on top of tennis net. Simply place on outside of service line. Flip cards go from 1 to 6. Sets up fast with no tools needed. Just insert two holding clamps to top of net.

SCO-2





Court Tray & Basket

Time-tested court valet system. Every tennis court should have this set up. **TRAY** is made of high quality UV stabilized poly. This is a one piece design that quickly attaches to post with supplied stainless steel clamp. Super competitive price!

BASKET is made of sturdy plastic in USA.

We drill drainage holes and attach special hooks to the the basket for it to hang below the **TRAY**.

Basket can also be hung on the fence. Holes are drilled in the bottom of basket to allow rain water to drain out. Available with matching color **TRAY**, in green and black.

- # TRY-BK Tray with clamp, Black
- # TRY-G Green
- # BAS-BK Basket, Black
- # BAS-G Green
- # TNB-BK Basket and tray set, Black
- # TNB-G Green set

Hooks

Clamp secures tray to post

Also can hang on fence



Top Seller!



Tourna Dri - Blue Squeegee

TOURNA DRI is a superb roller squeegee. The frame and housing is made of gray powder coated sturdy steel design which will prevent warping, bending and rusting. The "T" is made of stainless steel to prevent breaking at the stress point.

TDRI-1



36" PVA Replacement Roller. Fits other 36" squeegees.

TDRI-R - roller - blue

Tourna Dri Ready Roll - Black squeegee

- More durable and longer lasting than PVA rollers
- Made of revolutionary Synthetic Rubber Composite
- Immediately ready to push water off court. No wetting necessary.

- # TDRI-BK Squeegee and roller
- # TDRI-BK-R Replacement black roller

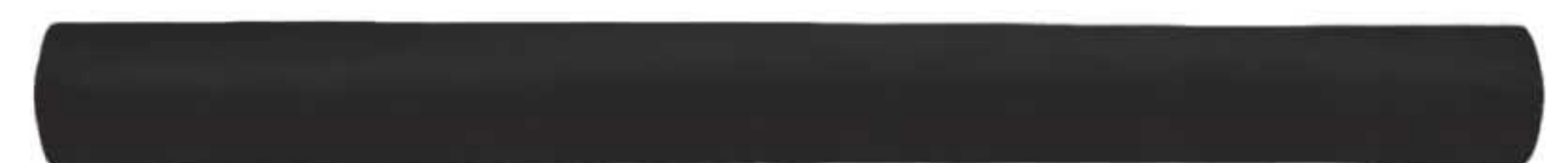

Tennis Practice Rally Pro

Can use to practice Pickleball



7 ft wide x 7 ft high tennis rebounder. It gives you hours and hours of practice. Easy to set up. Quick adjustment tilts the net to change the ball rebound.

Set on driveways, inside garage or backyard. Net stretches taught inside steel tubular frame with heavy duty elastic netting cord.

REB-7

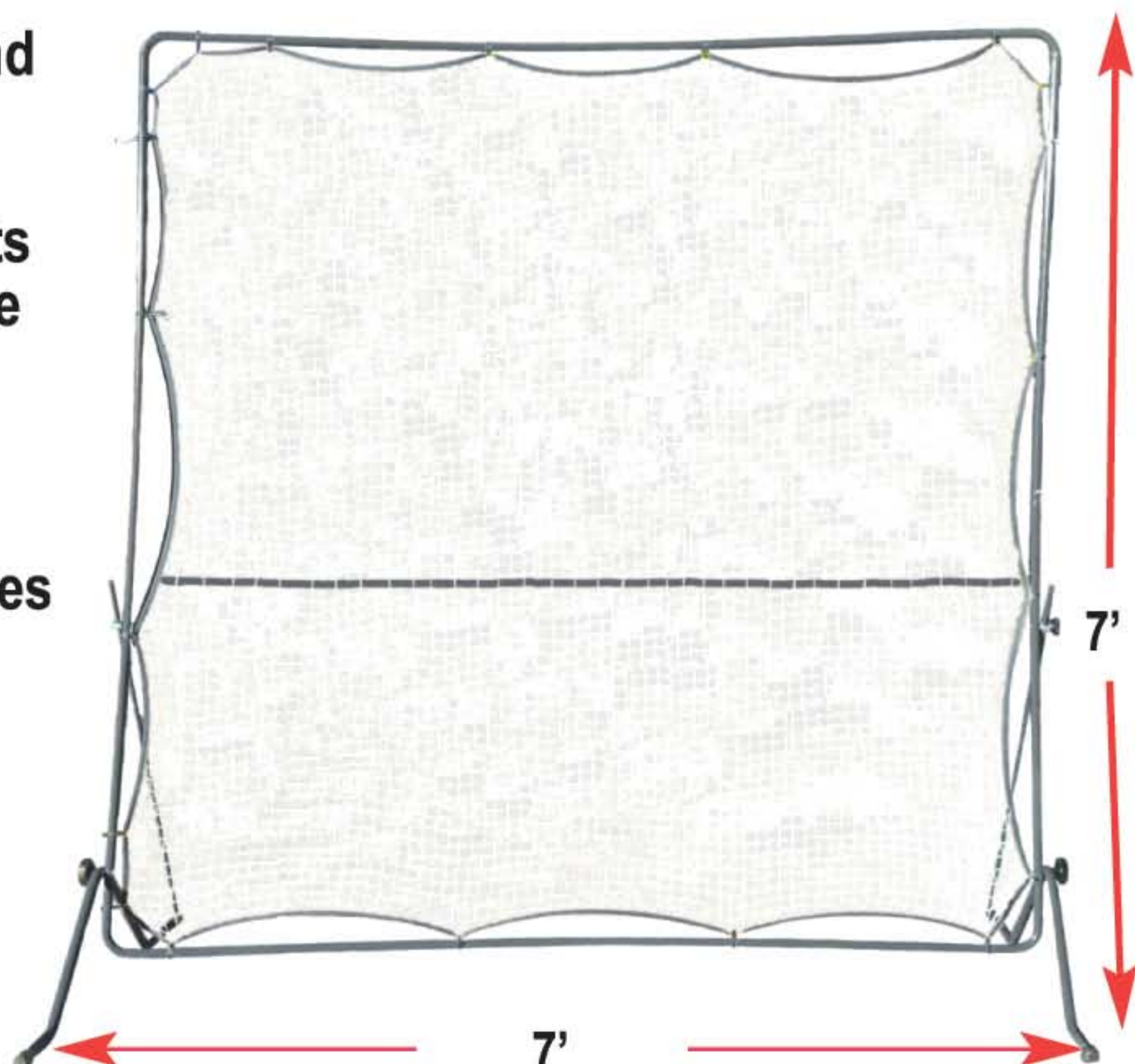

Can use to practice Pickleball

Tennis Practice Rebounder

9 ft wide x 7 ft high tennis practice rebounder. A very silent backboard which delivers hours of practice for beginners and kids.

Excellent for driveways, garage, tennis court. Net stretches taught inside steel tubular frame with heavy duty elastic cord. Heavy duty netting gives realistic like response.

REB-9





Tennis Nets

quality craftsmanship ... made in India



What you need to know about qualities of a good Tennis Net

THE WEAKEST LINK: The tiny rows of thread that stitch the net headband to the net body get the most abuse. They are pounded every day by ball strikes. This will weaken the stitching and make it come apart. You may have seen the net separate from the headband as if it was ripped. This occurs when inferior stitching is used. Make sure that the net description states that it has at least 4 rows of polyester stitching which is UV treated to prevent damage from the sun. The sun breaks down unprotected thread and the constant pounding by tennis ball further breaks it down.

THE NET HEADBAND: Most headbands are made of vinyl or polyester materials. Only good quality grades of the two materials create a long lasting headband. Poor grade becomes brittle causing crack and fall apart. Inferior polyester will fray and fall apart long before the rest of the net has reached its useful life.

THE NET BODY: Most of the abuse the net has to absorb is in the top area where the stitching and the headband are pounded. Most shots that impact the net are at the top and center from the serve. This is why we recommend a net with at least 3.0mm net body with a double net body for the first six rows. This extra layer of body provides double protection where it is needed the most.

SIDE-STICKS: A good quality net will have fiberglass side-sticks, and not wooden sticks which will eventually warp and rot.

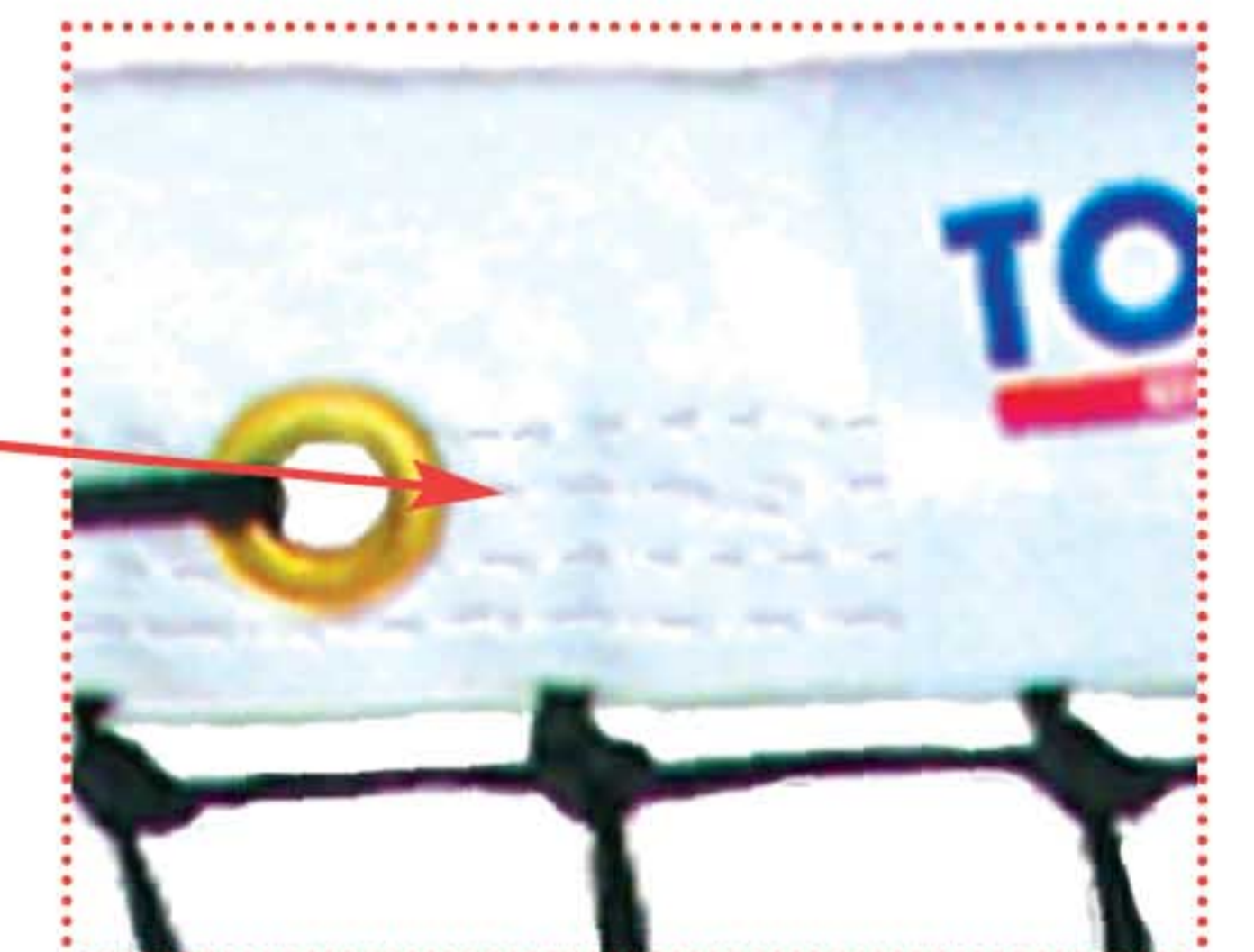

Double net body for first 6 rows

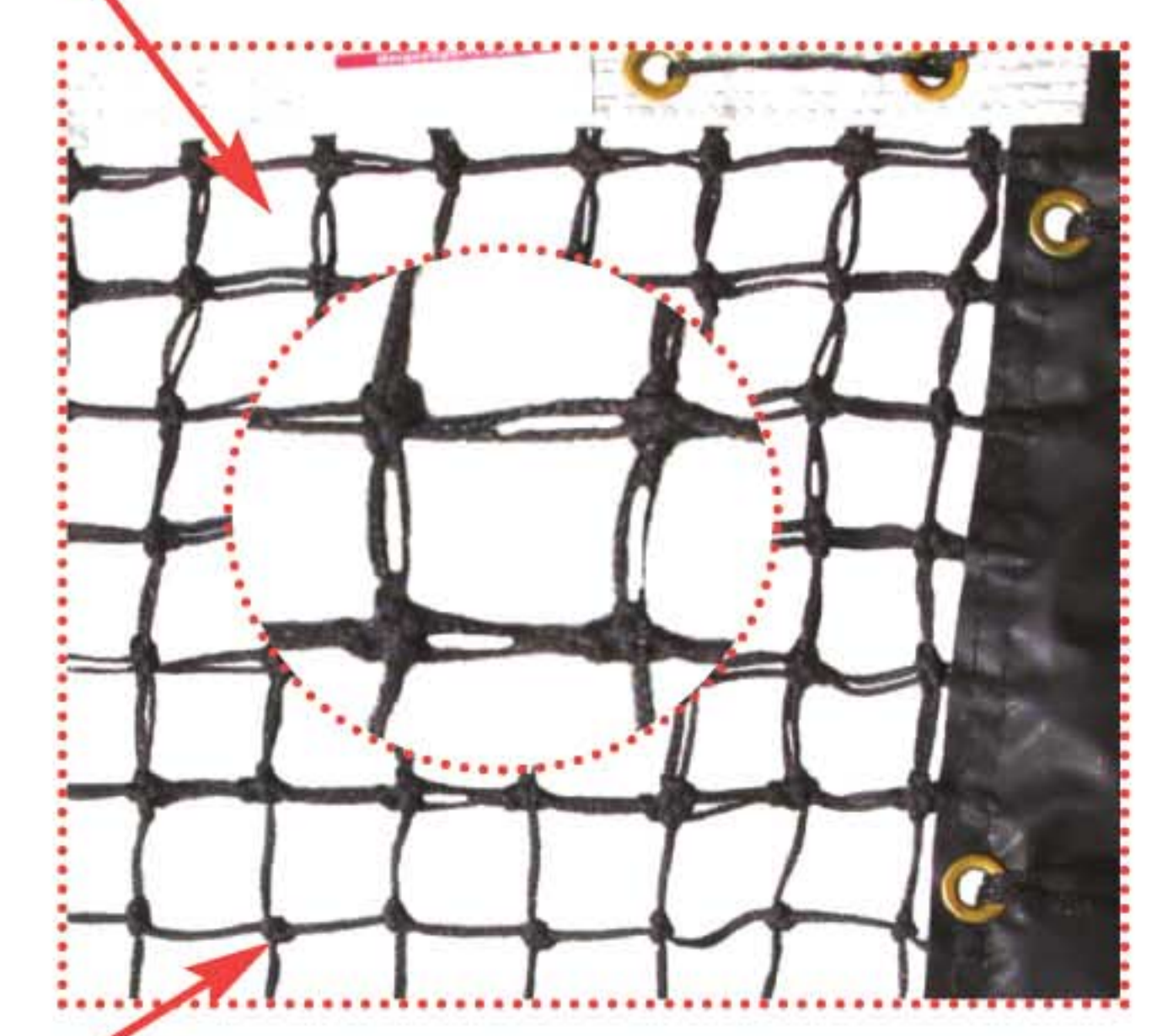

Single net body to bottom of net

TOURNA®

UniqueSports.com

*** TOP QUALITY - MADE IN INDIA ***

Tourna TENNIS NET - Double Braid

7 Double Braided rows at top Poly-material

Comes with:

- * Yarn is 500, FIRST GRADE quality
- * 2.5" white UV treated Vinyl headband with 4 rows of polyester stitching (vinyl coating & stitching is treated with UV and mildew inhibitors).
- * Sides and bottom are trimmed with black tape.
- * It is made with a vinyl covered 6mm steel cable.
- * Side sticks are 1/2" thick fiberglass to prevent bending /warping.
- * Breaking strength 145 KGF (almost double of other nets).

You can depend on our superb quality with a 2 year warranty.

Free Deluxe Net Strap included



TND - D, 3.5 mm - Poly (Tapered) - DELUXE
Lasts in extreme climates



TN-D 3.0 mm - Poly (Tapered)

Tourna TENNIS NET - Single Braid

Single Braid Poly material

Comes with:

- * 2.5" white UV treated Vinyl headband with 4 rows of polyester stitching (vinyl coating & stitching is treated with UV and mildew inhibitors).
- * Sides and bottom are trimmed with black tape.
- * It is made with a vinyl covered 6mm steel cable.
- * Side sticks are 1/2" thick fiberglass to prevent bending and warping.

You can depend on our superb quality with a 1 year warranty.

Free Deluxe Net Strap included



TND - S 3.5 mm - Poly (Tapered) - DELUXE
Lasts in extreme climates



TN-S 3.0 mm - Poly (Tapered)



Court Numbers

Court numbers from # 1 to # 12 on **wind screen material**. Printed on windscreen with white numbers to give the court an elegant look.

The 9 3/4" windscreen square is grommeted on all four corners for quick and secure installation with wind screen ties. Blends in with your existing wind screens for classic look. Unlike hard plastic numbers, the wind screen material will not be broken or ripped off by high winds.

CNO -1 through # CNO - 12

Club Wind Screen

Made of durable, UV stabilized polyethylene which is incredibly abrasion resistant. It is highly flexible which makes it excellent for high wind areas.

It's grommeted along all sides.

Available in black or dark green only.

Prefabricated in 6 feet high x 60 feet wide;
No Air vents; 73% Air and Light blockage;
Weight: 8 oz. / sq. yard; Grommets 12" on center

WS-60BK - Black (6 feet high x 60 feet)



S Hooks

These are helpful when initially installing the wind screens.

50 S hooks / pack
SSH-50



Deluxe Tennis Net Center Strap

One of the best tennis net straps made. Crafted with heavy duty polyester webbing. Comes with stainless steel double snap hook.

DNS-1



Wind Screen Ties

Designed to break before damaging your windscreen and or fence. They are 7" long and are designed for 50 lb break. UV treated.

100 Ties/pack # TYR -100



Tennis Net Check

Accurately measures height of a tennis net. Plastic tool folds neatly. Lip at top of Net Check is designed to rest on top of the net when checking net height.

NET-1



Opens to 3 ft net height

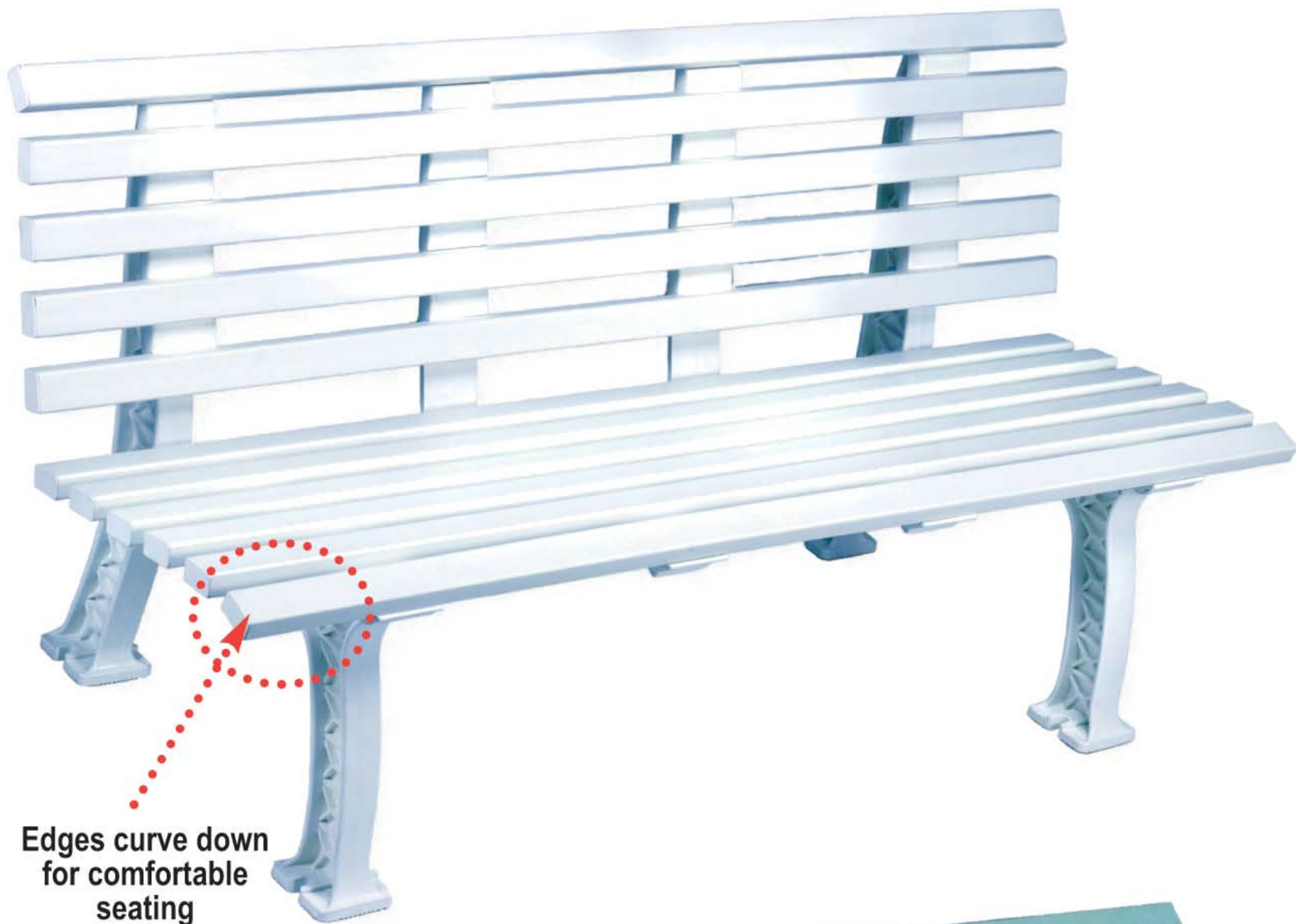

Edges curve down for comfortable seating



TournA Court-Side Bench - Heavy Duty

Made from high density, maintenance free polyethylene and PVC. It weighs 42 lb. which makes it very sturdy, solid and very attractive. This is a strong, heavy duty court bench designed to last in all weather conditions. Treated with UV and mildew inhibitors.

Very comfortable to sit on and supports even big men. TournA Bench can be bolted to any hard surface. Easy to assemble.

Available in white or green.

TCB - 5W White - 5 feet

TCB - 5G Green - 5 feet

cube: 6.8 (61" x 27.5" x 7")

weight: 42 lb

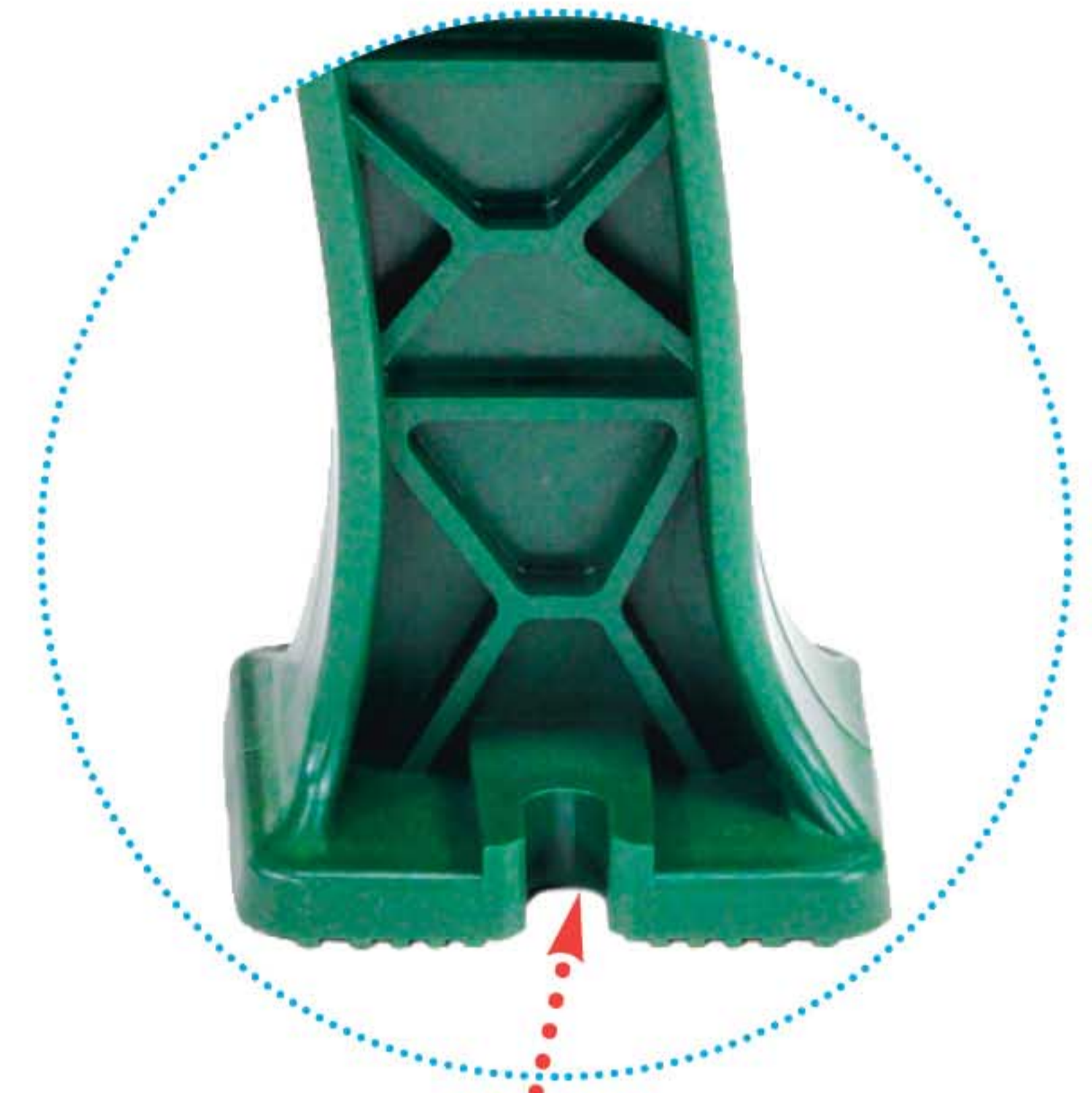

Can be bolted to any hard surface to make it theft resistant

TournA Mid-Court Bench - 5 ft

TournA Mid-Court bench is ideal for use between multiple, side by side courts. Made from high density polyethylene and PVC material. This is a durable, maintenance free, mid-court bench designed to last indoors or outdoors. Equipped with middle legs for added support.

Very comfortable to sit on. Edges curve downward so they don't press into players legs.

TournA Mid Court Bench can be bolted to any hard surface. Available in white or green.

TMCB - 5W White - 5 feet

TMCB - 5G Green - 5 feet

cube: 3.7 (60" x 20.5" x 5.2")

weight: 17 lb



Edges curve down for comfortable seating

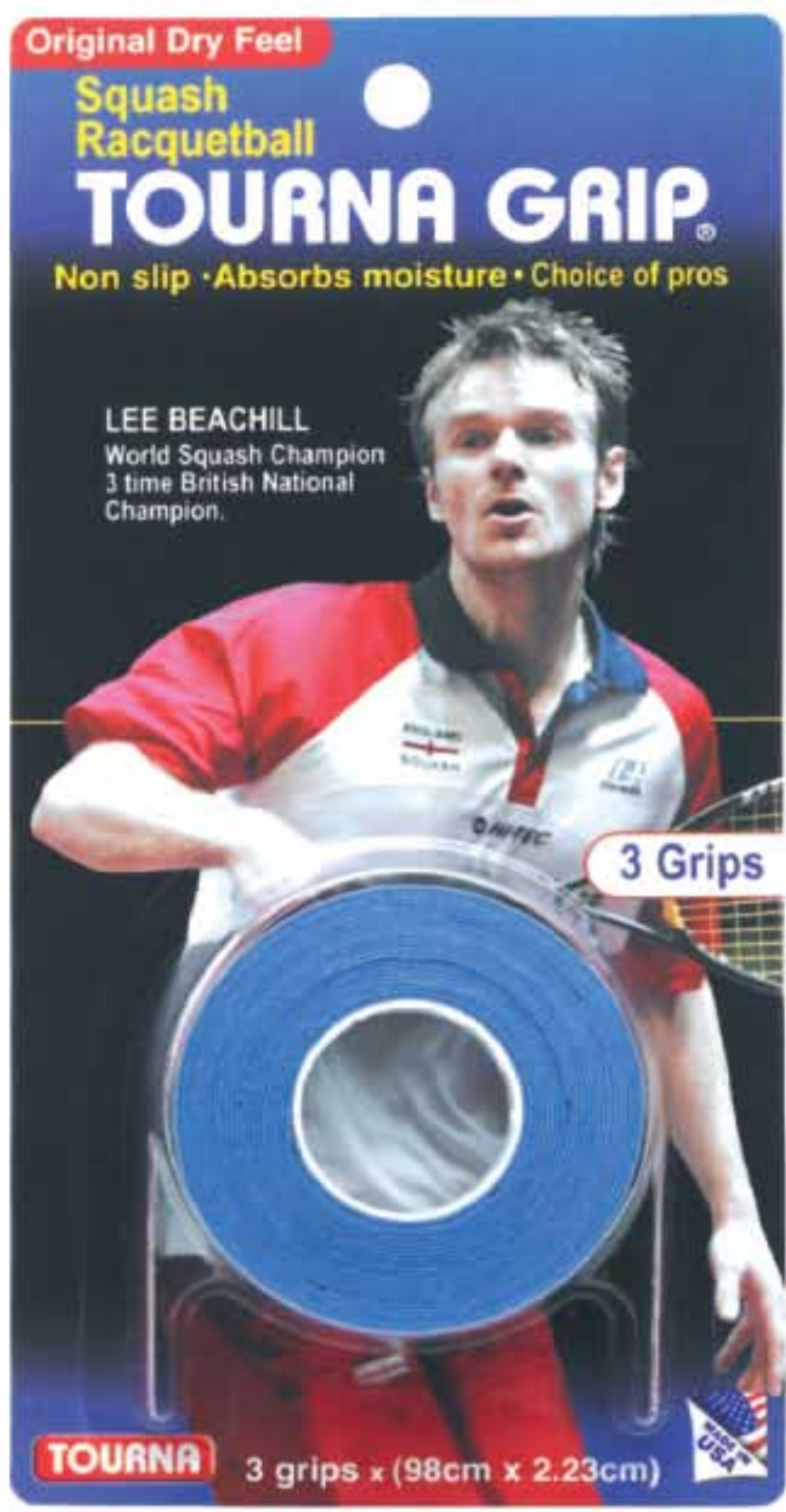

"Grip does matter, my choice is TournA Grip"

Lee Beachill
World Squash champion



TOURNA GRIP® Racquetball-Squash

Lee Beachill, former world squash champion plays with TournA Grip Squash grip. Lee is a 3 time British Champ. Lee has won 8 world titles in his 10 year career. To quote Lee:

"I have used TournA Grip in all my matches. I'm proud to endorse a product that has helped me in my squash career. TournA Grip gave me the perfect grip during the match. I didn't have to worry about grip slipping when the action really heated up".

TG-R- B

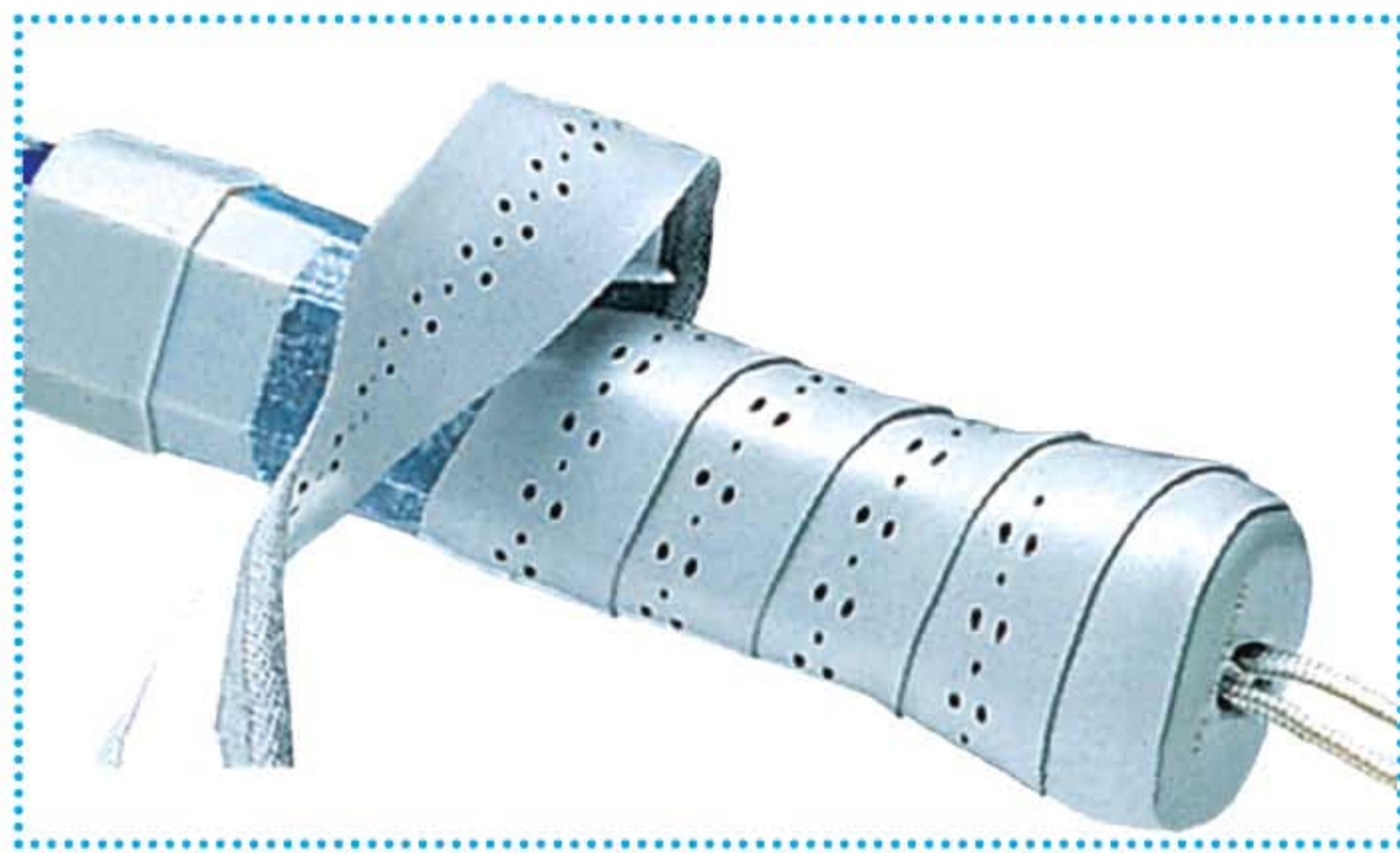

ReGrip Cushion - Replacement Grip

Replaces worn, original equipment racquet grip. Made of high tack polyurethane. Perforated so it absorbs moisture and enhances grip.

CRG-X Black, Gray

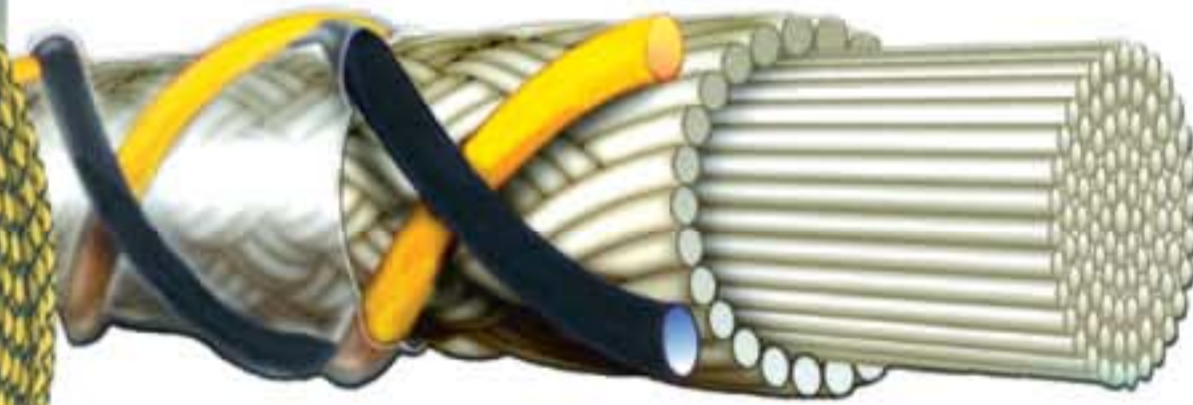

EXTREME POWER String

Extreme Power is a highly responsive racquetball and squash racquet string. It delivers power to player's shots. Made from thousands of extremely thin fibers that are twisted together and bonded. We textured the outside string layer with proprietary protective coating so the string bites into the ball for touch and control. It is 45 feet long...for the most oversized racquets.

XP-17 Gauge: 17 (1.27 mm); length: 45 feet
XP-100-17 Reel - (100m - 330 ft)
Color: yellow with black

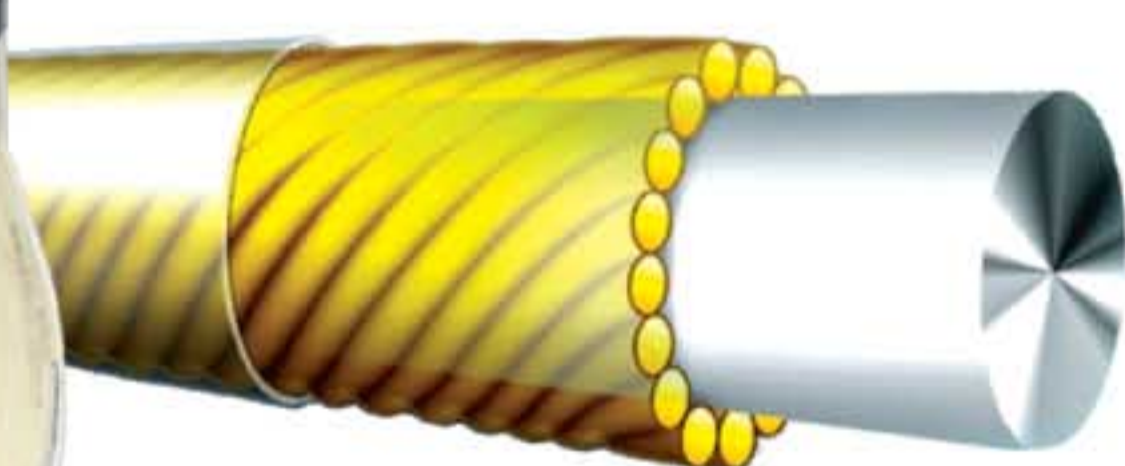
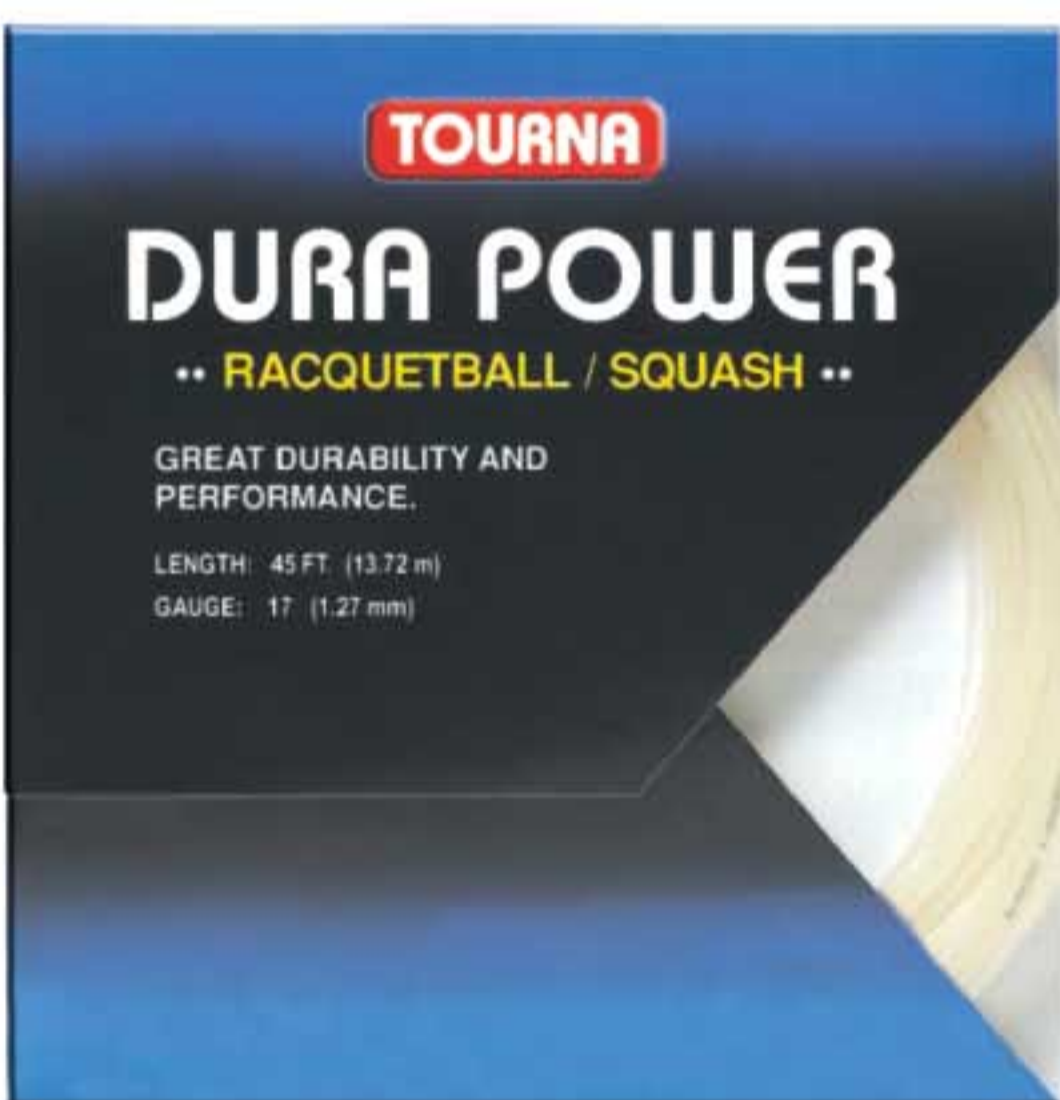

DURA POWER String

Dura Power is a performance racquetball and squash string. It's made of high tensile monofilament core with single layer of strong monofilament outer wraps. It has excellent playability and durability.

DBA-17 Gauge: 17 (1.27mm); Length: 45 ft
Color: light amber
DBA-200-17 Reel - (200 meter - 660 ft)

WRIST CORD

Positively secures racquet to wrist. Stops racquet from flying from players hand. The cord does not tangle. It is made of cotton and is washable. Assorted colors.

RWC-X (6/cs)



GLOVE SHAPER

Prevents glove shriveling from hand perspiration. Glove dries quicker after play and in a correct shape.

GS-1 (6/cs)



Racquetballs RESTORE®

Holds two racquetballs under pressure in a sealed container. Used by players for over 3 decades. Air is trapped and forced into a smaller area as you twist the Restore into closed position. The pressure keeps balls lively.

RST-R (6/cs)



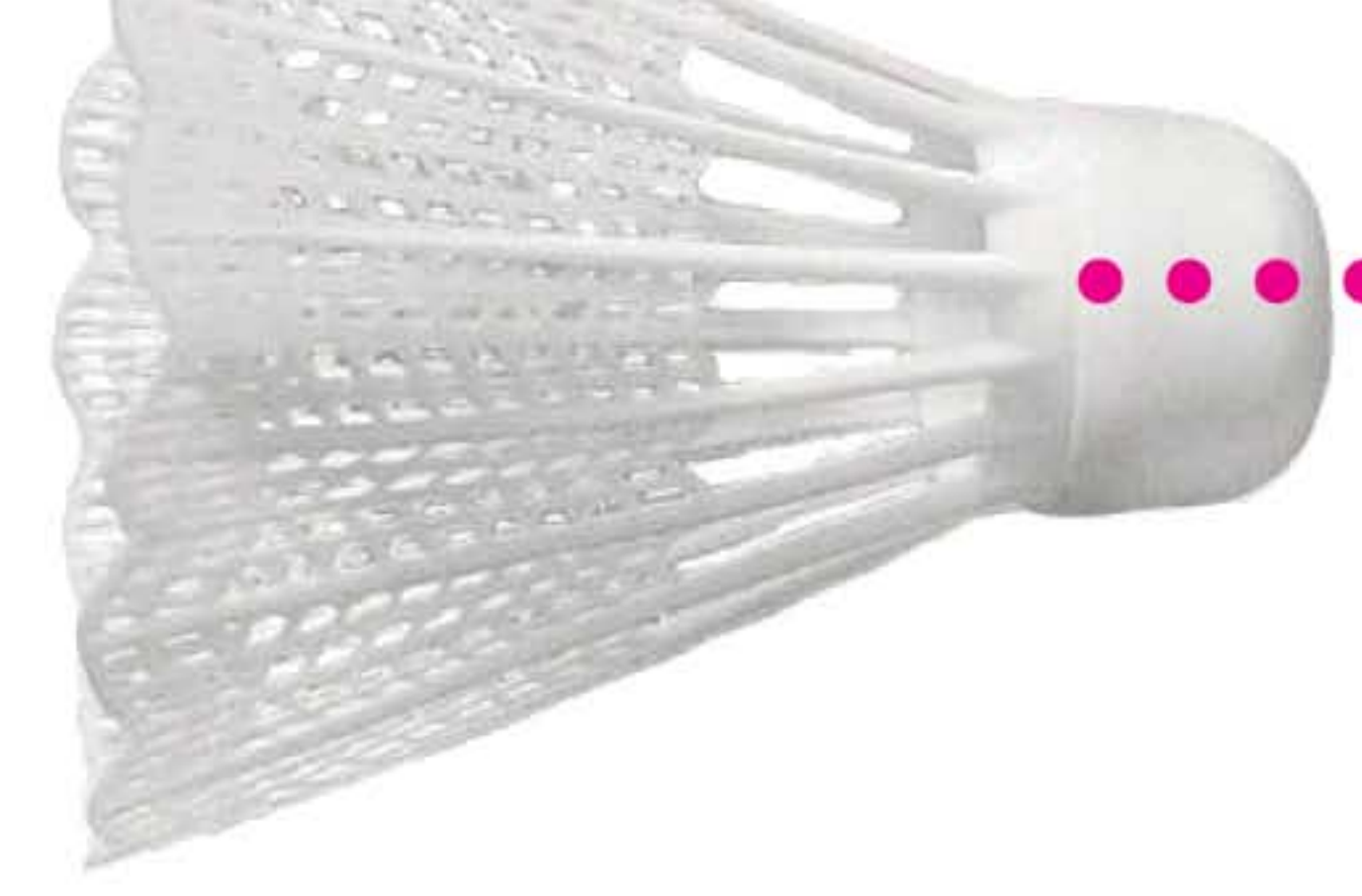

The Official Grips of :

USRBA - US Recreational Badminton Association

IBA - International Badminton Association

PBL - World Professional Badminton League



Endorsed by
Joachim Persson,
Badminton Pro,
career high # 6 in the world

Badminton MEGA TAC®

Mega Tac is the tackiest grip ever made...tackier than anything you've ever felt before...and the tack lasts 10x longer than any other tacky grip. Sized specifically for badminton racket handles.

- # BMT-2X-W White
- # BMT-2X-B Blue
- # BMT-2X-BK Black



Badminton TOURNA TAC®

Tourna Tac provides a tack grip that absorbs sweat and minimizes slippage. Sized specifically for badminton racquet handles.



- # BTAC-2-W White
- # BTAC-2-B Blue
- # BTAC-2-BK Black
- # BTAC-2-P Pink



DRY FEEL

TOURNA GRIP®



Pete Sampras



Bryan Brothers

1 Doubles in the world



John Isner

The only grip made in USA

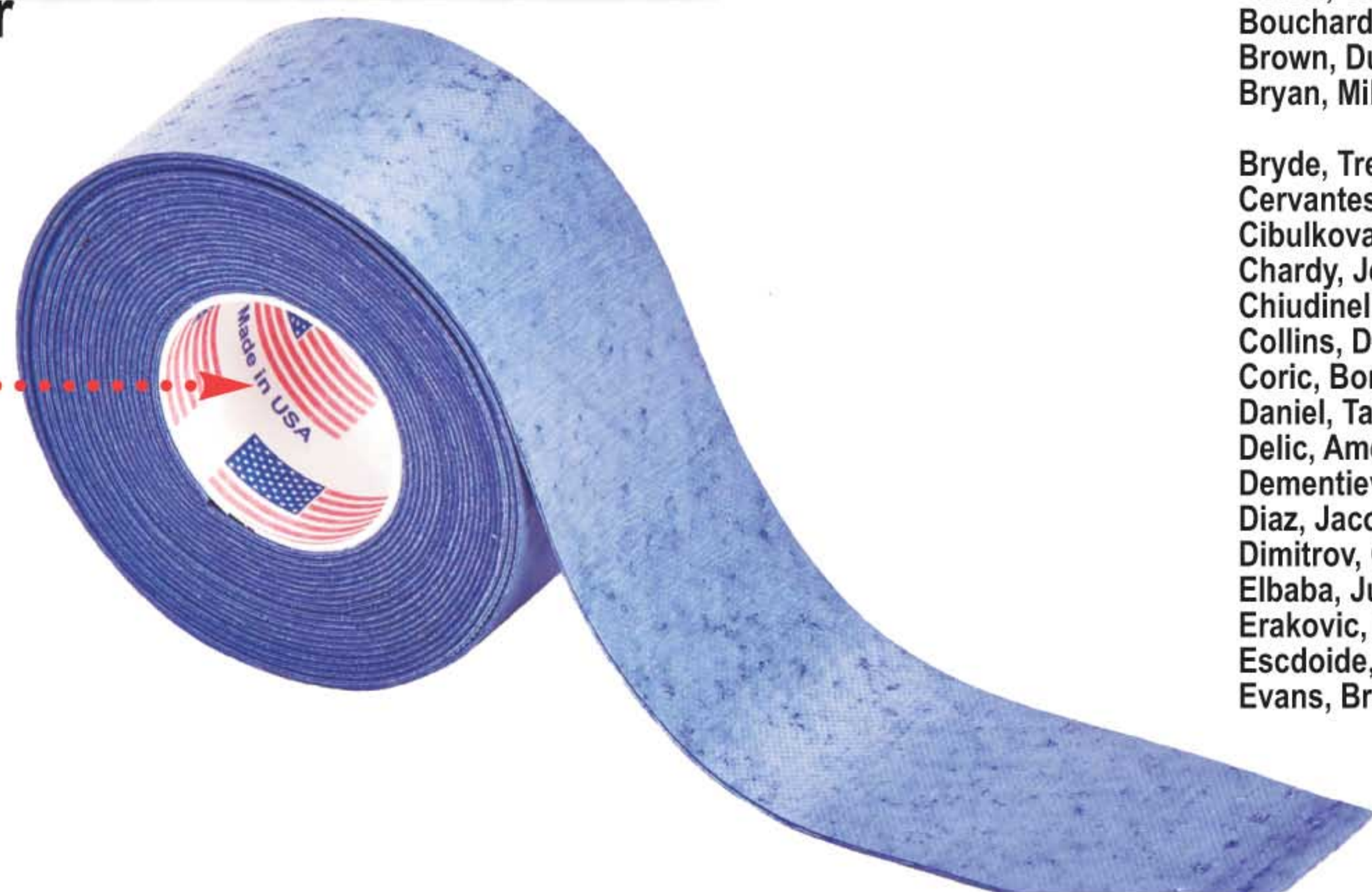

NATIONALLY ADVERTISED



TOURNA GRIP is the best selling grip in the world!

Why?

Because no other grip performs as well when wet. Other overgrips become slippery after a short period of use. Tourna Grip is a proprietary formula invented and developed in USA in 1977. Nothing like it existed before and no imitations have been able to duplicate its quality and performance. All other grips are made in Far East while Tourna Grip is made in USA.

We take special care in producing a top quality grip. Competitors change names and colors, we just keep making the same great Light Blue Color TOURNA GRIP.

Tourna Grip delivers customers.

CHOICE OF PROFESSIONALS

Almagro, Nicolas
Andreev, Igor
Anderson, Kevin
Arnold, Lucas
Azarenka, Victoria
Ball, Carston
Barry, Sam
Barty, Ashleigh
Becker, Benjamin
Bellucci, Thomas
Berloq, Carlos
Berrer, Michael
Bolelli, Simone
Bouchard, Genie
Brown, Dustin
Bryan, Mike & Bob

Fabbiano, Thomas
Falla, Alejandro
Ferrer, David
Fratangelo, Bjorn
Galfi, Dalma
Gabashvili, Teymuraz
Gasquet, Richard
Garcia Lopez, Guillermo
Gicquel, Marc
Gil, Frederico
Glatch, Alexa
Gojowczyk, Peter
Golubev, Andrey
Granollers, Marcel
Groth, Sam
Gulbis, Ernests

Knowels, Mark
Kozlov, Stefan
Kudla, Dennis
Lapentti, Nicholas
Lopez, Guillermo Garcia
Lorenzi, Paolo
Lu, Yen-Hsun
Luczac, Peter
Massu, Nicolas
Martin, Alberto
Mathieu, Paul Henri
McGee, James
McHale, Christina
Mayer, Florian
Mirnyi, Max
Monfils, Gael

Ramos-Vinolas, Albert
Robredo, Tommy
Rochus, Christophe
Rochus, Oliver
Roitman, Sergio
Russell, Michael
Sanchez, David
Schuettler, Rainer
Sela, Dudi
Schnur, Brayden
Seppi, Andreas
Shane, Ryan
Sharapova, Maria
Shvedova, Yaroslava
Silva, Rogerio Dutra
Simon, Gilles

Retired greats:

Agassi, Andre
Blake, James
Becker, Boris
Chang, Michael
Courier, Jim
Kuerten, Gustavo
Martin, Todd
Rafter, Patrick
Roddick, Andy
Safin, Marat
Sampras, Pete
Santoro, Fabrice
Seles, Monica
Wilander, Mats
... to name a few

Bryde, Tret
Cervantes, Inigo
Cibulkova, Dominika
Chardy, Jeremy
Chiudinelli, Marco
Collins, Danilla
Coric, Borna
Daniel, Taro
Delic, Amer
Dementieva, Elena
Diaz, Jacob
Dimitrov, Grigor
Elbaba, Julia
Erakovic, Marina
Escdoide, Ernesto
Evans, Brendan

Haas, Tommy
Hampton, Jamie
Hanescu, Victor
Harrison, Ryan
Hernych, Jan
Hidalgo, Ruben
Hiltzik, Jared
Isner, John
Johansson, Joachim
Johnson, Steve
Karlovic, Ivo
Kelly, Dayne
Kenin, Sophia
Keys, Madison
Khachanov, Karen
Kim, Kevin

Murray, Andy
Nestor, Daniel
Niemen, Jarkko
Novak, Jiri
Permentier, Pauline
Pospisil, Vasek
Puerta, Mariano
Puig, Monica
Peas, Leander
Pliskova, Karolina
Pouille, Lucas
Querrey, Sam
Quigley
Radulescu, Alex
Ram, Rajeev
Ramirez, Ruben

Smyczek, Tim
Sock, Jack
Stakhovskiy, Sergie
Thiem, Dominic
Teamy, Fin
Tipsarevic, Janko
Townsend, Taylor
Troicki, Victor
Tsonga, Jo Wilford
Tursunov, Dimitry
Vicente, Fernando
Wasek, Alexander
Witten, Jesse
Yim, Robert
Youzhny, Michail

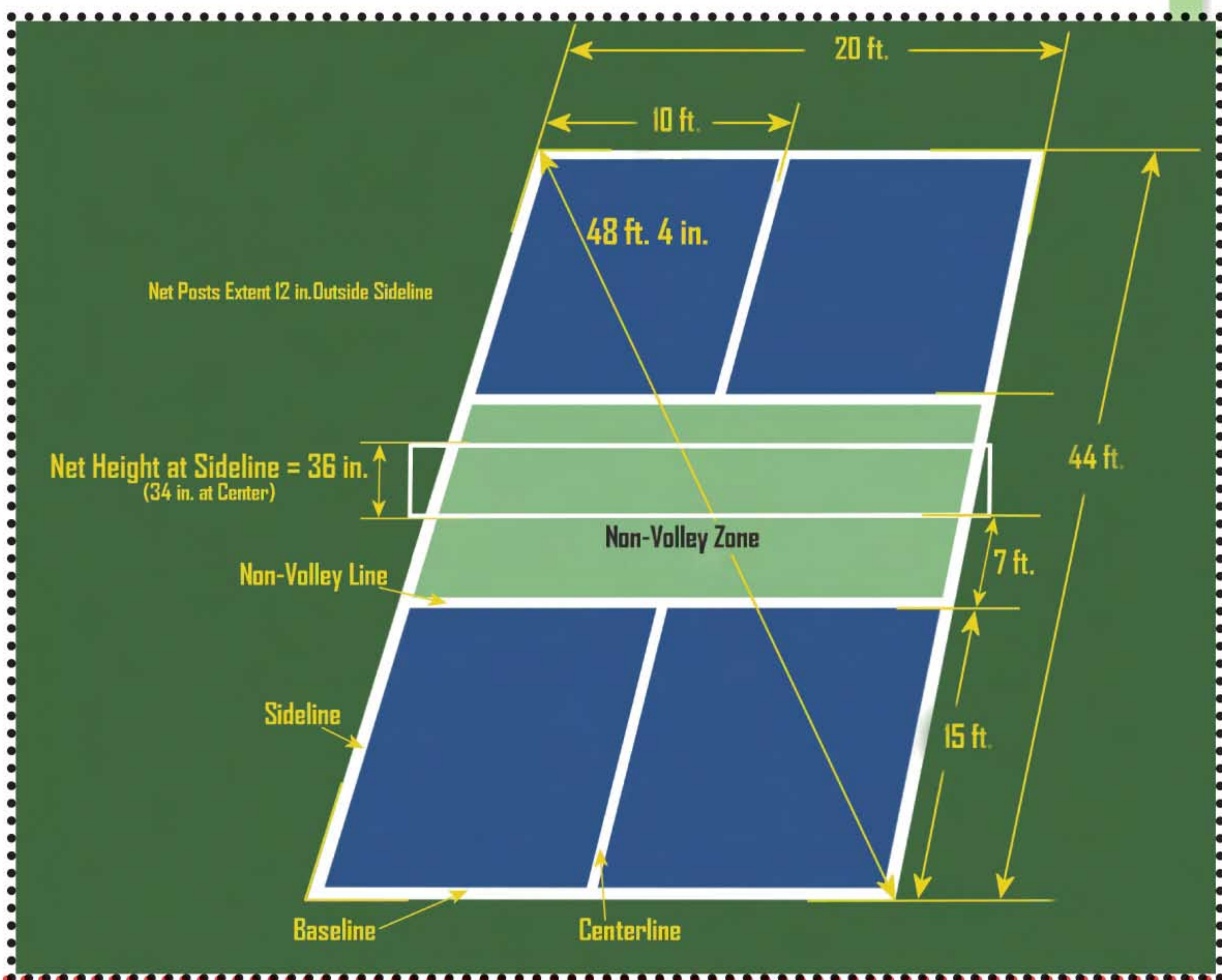

Pickleball Basics

Pickleball is a new paddle game capturing the interest of old and young. The game is easy to learn and play well quickly.

Game is played with a perforated, plastic ball and a paddle. Court dimensions and net are illustrated to the left.

The game starts with a server serving underhanded diagonally to the opponent's service zone. Points are scored by the serving side only and occur when the opponent fails to return the ball in bounds. Server continues to serve, altering service courts, until the server faults. Game is won by first side to reach 11 by a 2 point margin.

Pickleball is played indoor and outdoor. The balls for indoor play have 26 holes and are made of softer material. Balls for outside play have 40 holes, are larger diameter and the material is harder. Various colors of balls are used for indoor play. Darker colors are seen better when surrounding walls are white.

Pickleball NET

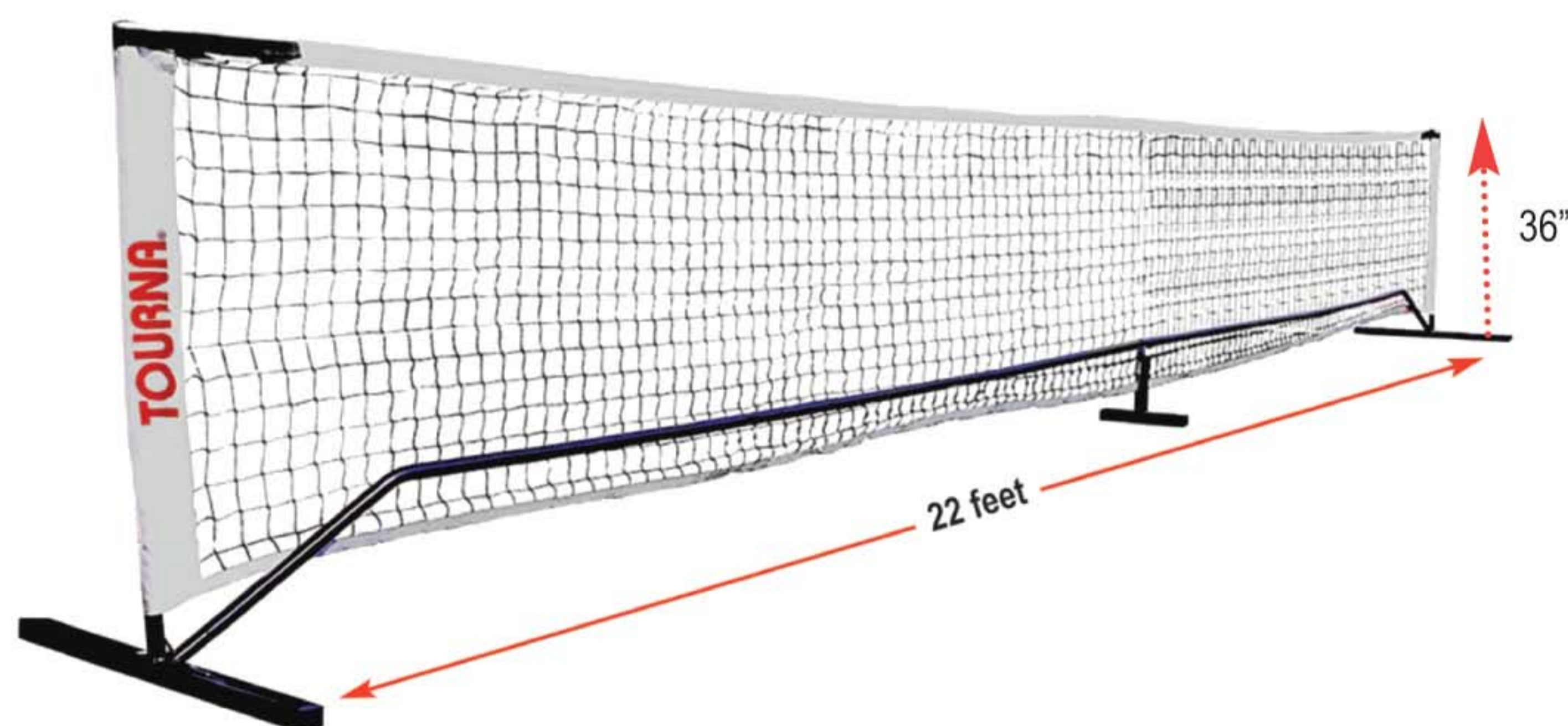

22' official size tennis nets for Pickleball court. Portable and lightweight for quick and easy set up. Set up on neighborhood street for a block Pickleball party.

- Handy carrying case with shoulder strap
- Black steel frame base
- Adjustable sleeve net - 34" high at center
- Velcro base straps

P-NET

Pickleball **INDOOR** play

Regulation size for Indoor play. Meets USAPA/IFP specs for diameter, bounce, and weight. Made of very durable plastic with 26 holes. Indoor balls come with larger holes and are slightly smaller than outdoor pickleballs.

Available in: Optic Yellow, Lime Green, Red, Blue, and White in 3, 6 & 12 pack.

- # PIKL-3-W, OY, LG
- # PIKL-6-W, OY, LG
- # PIKL-12-W, OY, LG bag
- # PIKL-40-OY (in Tote)



Pickleball **OUTDOOR** play

Regulation size. Meets USAPA/IFP specs for diameter (74 mm), lively bounce, and weight (24.5 grams) for outdoor play. Made of hard, dense, durable plastic with 40 small holes.

Available only in Optic Yellow in 3, 6 and 12 pack

- # PIKL-3-OY-O
- # PIKL-6-OY-O
- # PIKL-12-OY-O
- # PIKL-36-OY-O (In Tote bag)
- # PIKL-200-OY-O



Tourna Pickleball Mega Tac®

Proprietary tacky PU coating clings to your hand. Mega Tac grips you back with max tack that lasts and lasts! Prevents slipping, sliding and minimizes blisters.

Available in white, blue & black

YOU NEED TO FEEL IT!

P-MT-W, # P-MT-B, # P-MT-BK

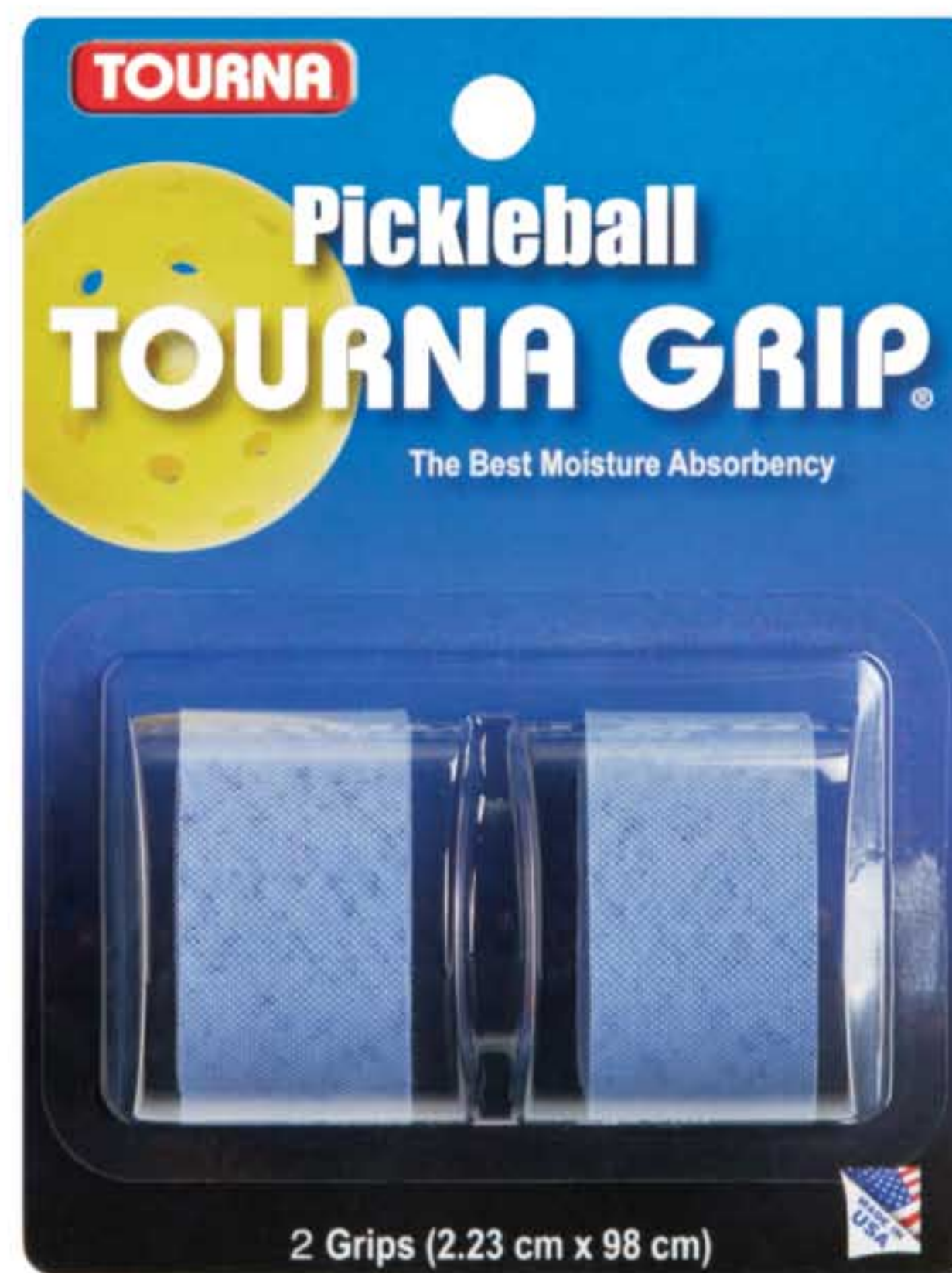

Pickleball TOURNA GRIP®

Designed to fit Pickleball Paddles

- Absorbs hand sweat better than any other grip
- Prevents twisting, slipping, sliding
- Minimizes blisters

P-TG-B



Tourna Pickleball Grip

Made specifically for Pickleball Paddles

- Polymer cushion material provides max comfort
- Perforated for moisture absorption.

Recommend you overwrap with Tourna Grip in very humid conditions.

P-CTGS-BK, 31" LONG

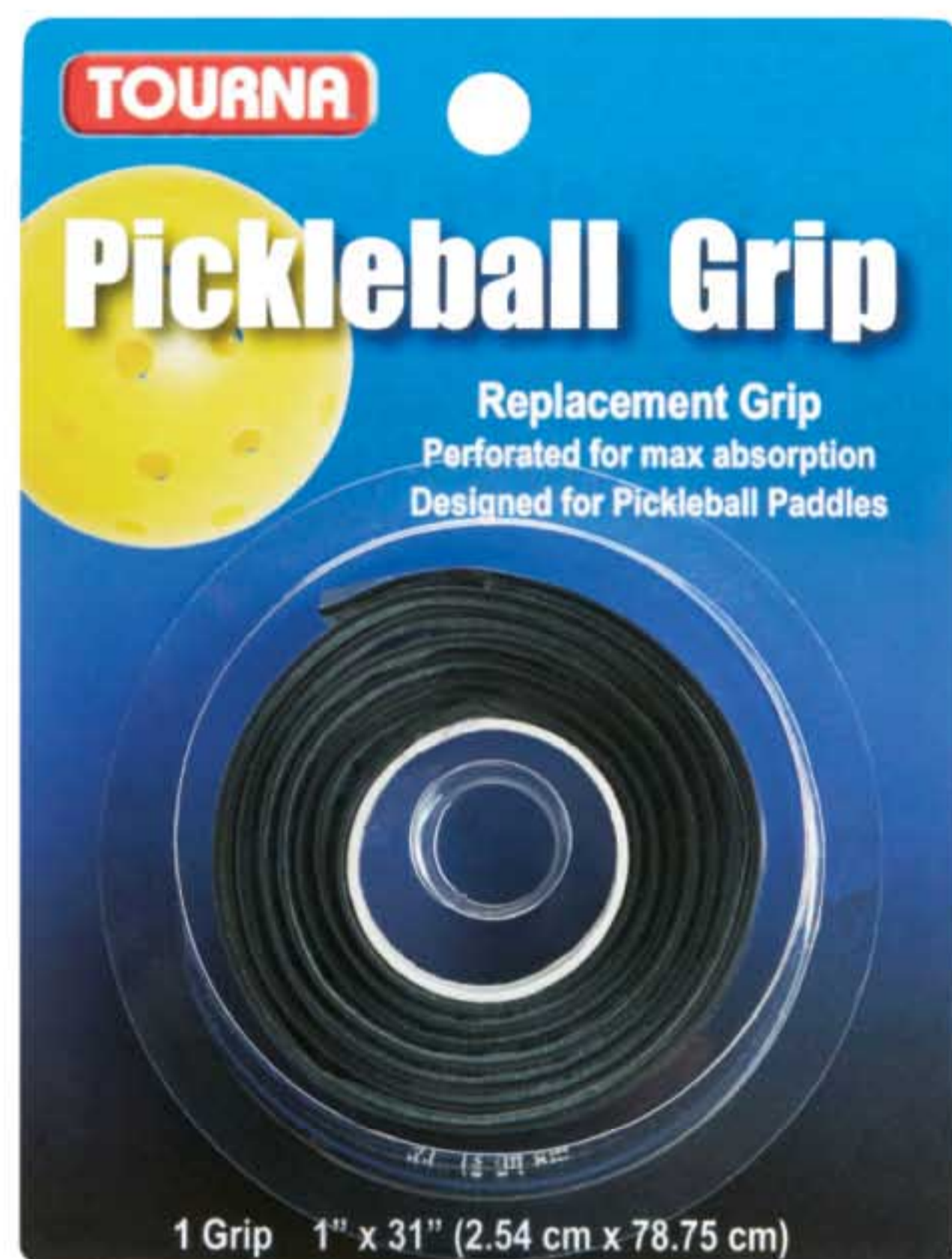

Tourna Pickleball Cushion Grip

Unique elastomer pad below synthetic grip creates a superior cushion grip. It protects your hand from ball impacts by absorbing shock from paddle.

- Prevents twisting, slipping, sliding
- Minimizes blisters

P-C-BK, 31" long



Tourna Pickleball BALLPORT®

Mini Ballport - 20 + Balls

Picks up Indoor and Outdoor Pickleballs after practice. Pick up mechanism rolls the balls into Ballport with ease.

P-BPD-W, With Wheels
P-BP-M, Mini



P-BPD-W
HOLDS 50 INDOOR,
AND 45 OUTDOOR
BALLS

Down position
to pick up balls

Bars at top slide
to hold the balls in
for transport



With wheels
for easy transport



P-BP-M
HOLDS 24 INDOOR,
20 OUTDOOR BALLS

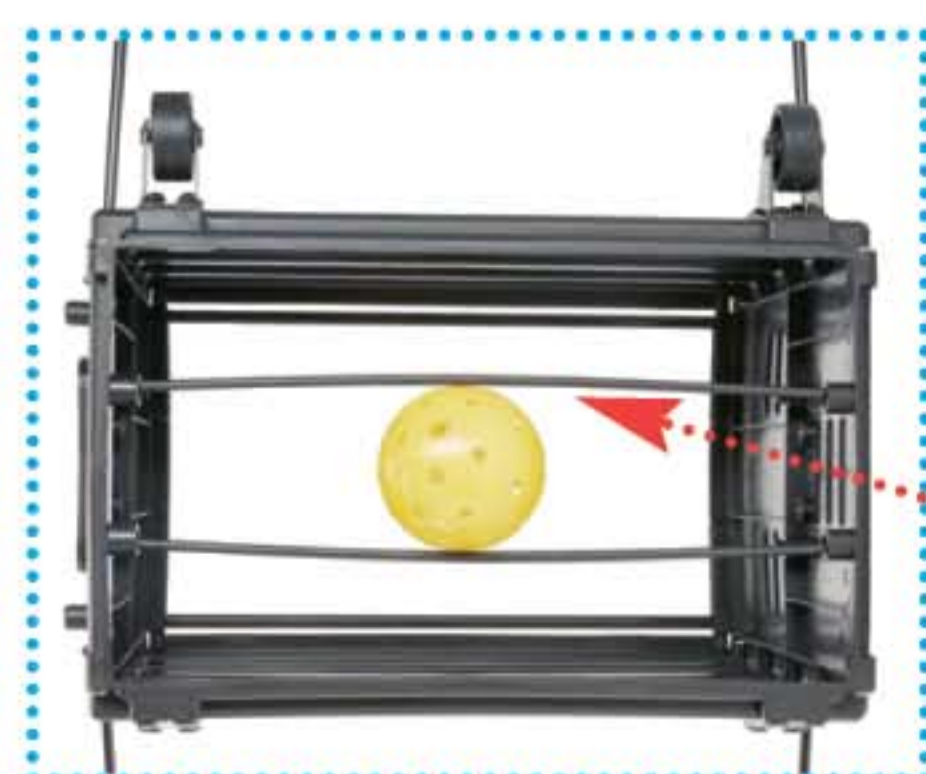

Flexible rods
allow pick up
of indoor and
outdoor balls

Tourna Pickleball TUBE



46"

Pickle Ball Tube picks up up to 16 balls. Just press over the ball to pick into Tube. Avoids bending and picking up by hand. Made of durable, lightweight plastic. Elastic band at the top secures the ball inside the tube for easy transport.

PIKL-TU

Bottom view
shows the
unique rubber
prongs that
allow
different size
balls to be
picked up.



Tourna Pickleball Lead Tape

Add extra oomph to your hits by adding weight to the paddle. The extra weight of lead stabilize the paddle at impact. It will deliver more punch and solid shots with less arm strain.

Adhesive backed for easy placement on the paddle for desired result.

P-LD



Lead Tape applied

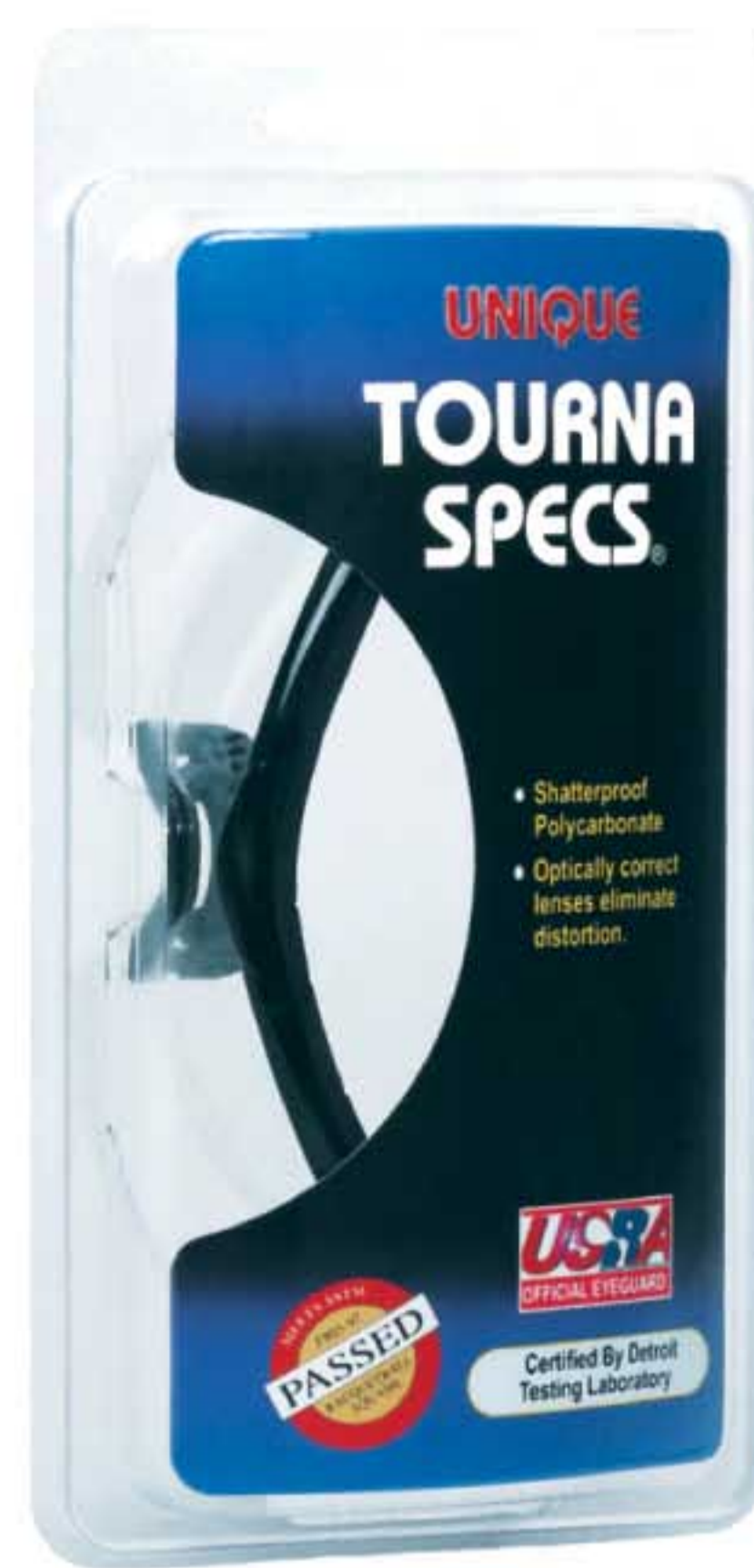

Tourn Specs®

The finest eye protector you can own. Passed the rigorous ASTM F 803-97 testing by Detroit Testing Laboratory and are certified. Made of shatterproof polycarbonate. Lenses are precision ground to deliver distortion free view.

Approved for: racquetball, squash, tennis, lacrosse, badminton, basketball, street hockey, and baseball.

- # TS-C Clear lens - Adult, clam pack
- # TS-A Yellow lens - Adult, clam pack



Prescription Adapter

Adapter fits on the inside of the Tourn Specs. Go to an ophthalmologist to make your prescription lenses.

TS-PA



Super Specs®

This is the classic eye guard design, and still one of the best. It features **flow through ventilation** design to minimize fogging. Made of shatterproof polycarbonate with **anti-scratch coating** and **anti-fog treatment**.

Super Specs has 180 degree full view and is distortion free. Proven in tournament play since 1985. Passed the rigorous Detroit Testing Laboratory tests with balls fired at 100 miles per hour at the eyeguard.

- # SUP-1 Adult, clam pack
- # SUP-Y Youth / ladies, clam



Can be displayed vertically on shelf



Comes with lenses which can be removed to fit prescription lenses.



Rx Specs®

Lenses are **removable** to accept prescription lenses. Optician fits frame with your prescription lenses. This is the same frame that opticians sell for \$80.00 or more.

Frames are made of shatterproof polycarbonate. RxSpecs come with distortion free non-prescription lenses. This classic model can be used in racquetball, squash, soccer, lacrosse, basketball, football.

REC-X



Great Specs®

Crafted in the same mold used for Super Specs. We package it on a blister card with economy strap and do not apply anti-scratch coating. This is a **great** eyeguard with fewer bells and whistles.

Great Specs offers anti-fog coating, flow through ventilation with distortion free lenses. Passed the testing ASTM F 803-97.

GRE-1 Adult, blister card



Racket Specs™

A low profile eyeguard. Side vents are open to minimize fogging. Made of shatterproof polycarbonate. Lenses are precision ground to eliminate distortion.

EP-2



Over Specs™

Fits right over most prescription glasses. Lightweight and comfortable to wear. Made of shatterproof polycarbonate. Lenses are optically correct with no distortion.

OS-1

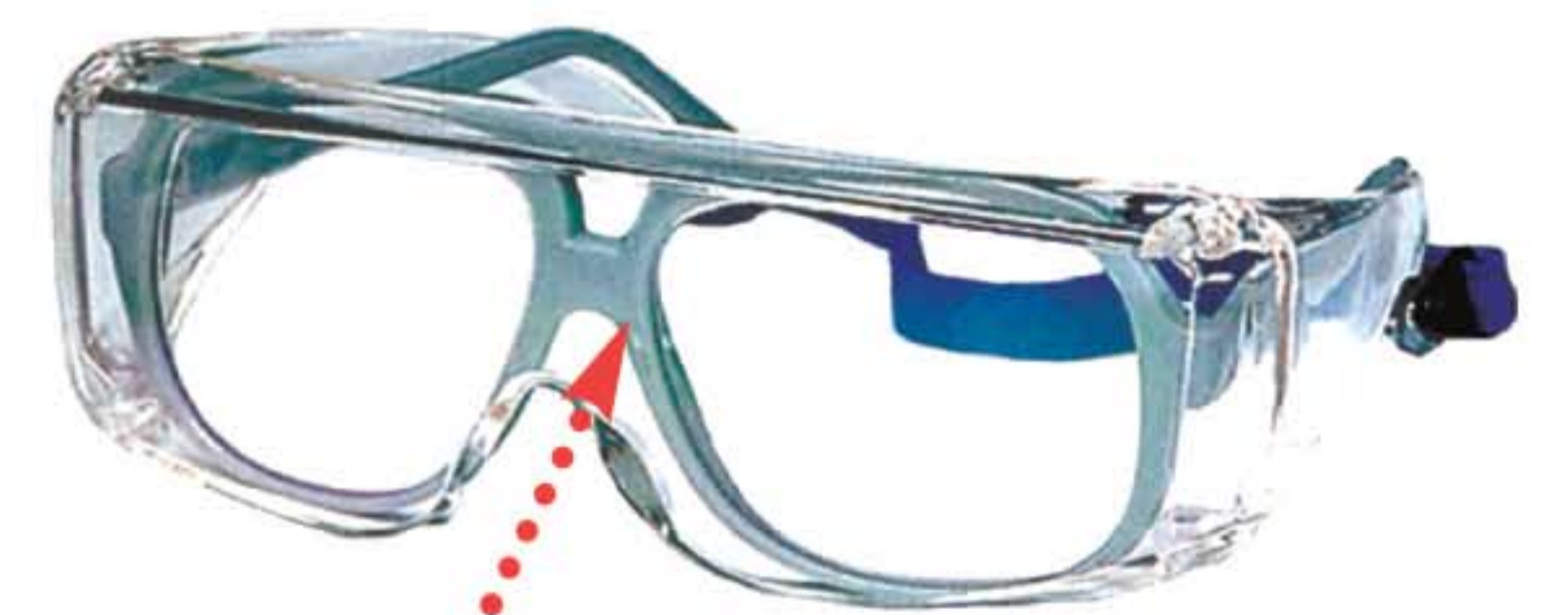

Note glasses on the inside



Lens Clean

Cleans and imparts anti-fog static coating to all eyeguards, glasses, and polycarbonate coated lenses. Spray and wipe with enclosed microfiber cloth.

Lens Clean sells great when placed next to eyeguards. Your customers need it.

LC-1

Eyeglass Holders

Eyeglass Holder



The classic design that securely holds glasses on your head. It is made of elastic stretch material with infinite adjustments. Fits every size head comfortably. Washable. Black color.

EGH-1

Top Seller!



Adjustment Clasp

Bear Hugg®

Just slide on and you are ready for action activities. As forces tug on Bear Hugg, it constricts and grabs on even tighter. If glasses should fall in water, they float. Washable.

Colors: Black, Royal Blue, Red.

BH-1



Eyeglass Huggy®

Thick nylon tubes slide over the arms of glasses. For added safety, rubber tubes are in the entrance of Huggy. The rubber grips the glasses. Sliding bead adjust for tight fit. For skiing, extreme sports, etc.

Washable.
Colors: Black, Blue, Red.

HUG-2



Bead slides to secure to head

Specs Cord

This is an ideal leash for glasses. Never forget where you placed your glasses... they hang from your neck. Very thin and light. Black rubber clasps slide over the arms of glasses and are secured with sliding brass spring. Available in assorted colors.

EGC-1 Assorted



Specs Strap

Very thin tube slides over glasses side arms. The adjustment bead is small and it slides for perfect fit. Loosen the bead and Specs Strap becomes a leash to hang glasses from neck. Made of nylon. Washable. Available in assorted colors.

STR-X Assorted



Bead slides to secure to head

Caps & Visors

Quality, Performance, Affordable

Ultimate Cap

Made with mesh fabric so it's cool and feather light. As air passes around the head, it keeps you cool. Underbill is gray for better vision.

Cap has a plush headband for comfort fit. Unisex design. Velcro adjustable strap. Washable

This is a non logo cap and very affordable.

CAP-1 white

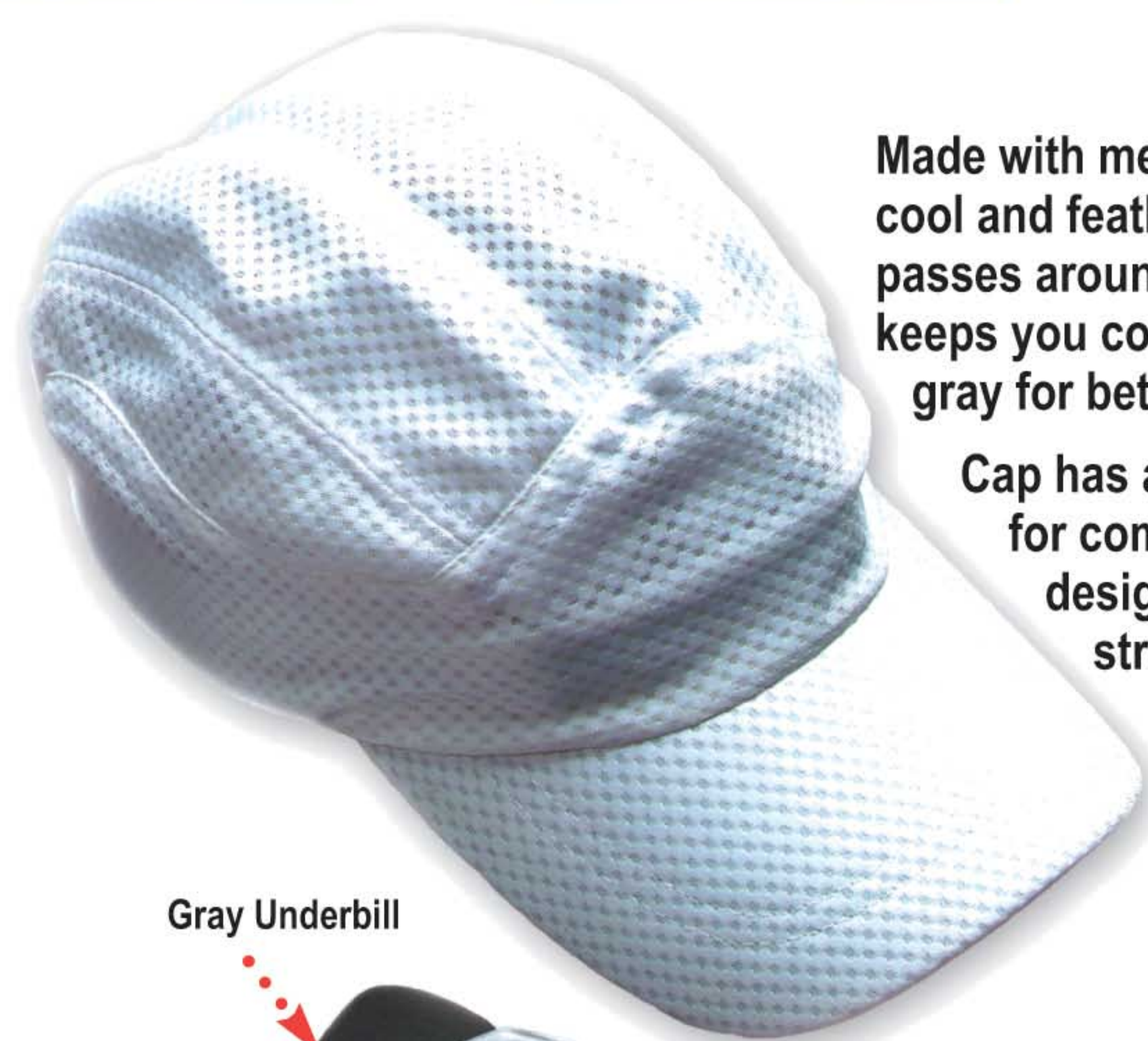

Gray Underbill

Plush Headband

Velcro Closure

Mesh Air Flow Material

Ultimate Visor

Made with mesh fabric for cool and light wear. Plush headband is in front for exceptional comfort. Machine wash and wear over and over again.

- Gray underbill cuts glare for better vision
- Adjustable Velcro strap
- One size fits all
- Washable

Exceptional Value Price

VIS-1, White



Gray Underbill Cuts Glare

Pro Cap

Keep a cool head with ultra light Pro Cap. The 4 mesh inlets on top of cap keep air circulating over head. The terry sweatband wicks away sweat. The black underbill reduces glare. The velcro closure on back ensures perfect fit. Pro Cap has a stylish bill that is narrow shaped.

The black trim around bottom of cap adds a classic look.

Made with 100% microfiber material. One size fits most.

Available with and without Tourna logo.

Mesh Air Inlets

PCAP-1 (No logo)
PCAP-T (Tourna logo)

Velcro Closure



Black Underbill Reduces Glare

Black Trim

Pro Visor

Pro Visor is the lightest cap or visor you will experience wearing.

- Stylish design with black trim around the base of visor
- Sweat wicking band for true comfort
- With quick adjust Velcro closure
- Black underbill reduces glare

One size fits most. Made of 100% polyester microfiber material. Available with and without Tourna logo. Washable

PVIS-1 (No logo)

PVIS-T (Tourna logo)

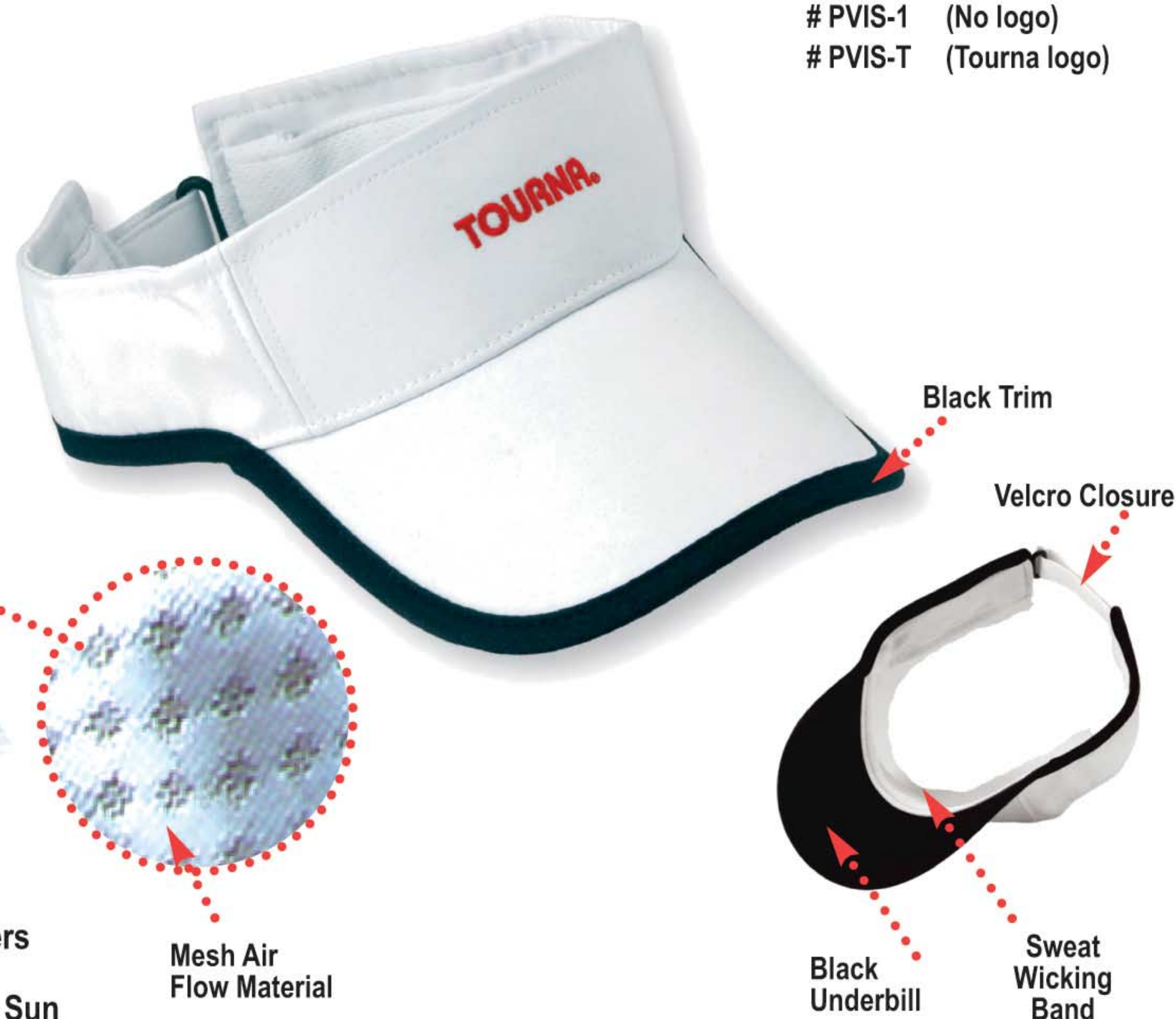

Black Trim

Velcro Closure

Black Underbill

Sweat Wicking Band

Aussie Hat

Made of mesh material for cool wear. Terry headband on the inside of hat wicks sweat out. Why is this old floppy hat still around? American Medical Association recommends that a hat / cap should have a brim around the head to protect the ear and neck from sun burn.

Available in: S, M, L and XL

AC-X White

Small: 23" (58.4 cm)
Medium: 23 1/2" (59.7 cm)
Large: 23 3/4" (60.3 cm)
XL: 24" (61.0 cm)



Covers Ears from Sun

Mesh Air Flow Material



TOURNA

COOLING SUPPORT

Place around neck
to lower the body temperature

LIQUI TOWEL® Cooling Towel

Dip LIQUI TOWEL in water and it gets cooler than the outside air but stays dry to touch. Put it in smaller cooler with ice water and pull it out on changeovers. It's like taking a cold shower without getting wet. Instantly cools & refreshes during hot and humid sport competition, workouts, or strenuous activities. Contains no harsh chemicals, fragrance, or alcohol. **Washable and Reusable!**

MONEY BACK GUARANTEE

If it doesn't cool after following our instructions, return the product with purchase receipt for refund.

Advanced PVA synthetic chamois material creates a cooling effect which is significantly cooler than ambient air. Hand wash with mild soap and rinse. Do not air dry. Place into zip lock bag or tube while still wet. Dampen before use.

Size: 34 cm x 81 cm long x 2 mm thick



COOL - B-T - Blue, in plastic tube

LIQUI Cool® Cooling Bandanna

Keeps your body temperature cool even on the hottest days. **How does it work?** Just soak in cold water for 10 minutes. Crystals embedded in the bandanna expand 400 times and turn into a cooling gel. **It will stay cool for 12 hours** or more. To recharge, just re-soak in cold water.

To clean, wait until dehydrated (two days). Hand wash with mild detergent, air dry, and use again. Put this item on a Clip Strip and blow it out during the hot summer months. **Millions sold.** We cut and sew and embed the crystals in USA.

Available colors: white, blue, black, pink, light blue, blue print, red print.

LIQ-X
LIQ-X-CS Clip Strip (12 per strip)

Dip in water
to activate



Top Seller!



Sport Towel

Made of 100% cotton, flannel, terry cloth. Thick and luxurious. Feels great. Size: 33" x 13"

ST-U

Personalize your towels
with club name or logo.
We can do it for you.



SweatBands



Thick Head & Wristbands

Double the cotton content (2 ply) of regular bands. Thick and plush, they soak up the moisture. Blister carded for greater perceived value. 94% cotton, 6% elastic. Made with non-allergenic, plush cotton in our USA knitting plant. Available in listed colors:



HB-X, Headband

WB-X, Wristbands

HWB-1, White combo
HWB-BK, Black combo



2 ply thick



Ultimate Head & Wristbands

SIMPLY THE BEST SWEATBANDS MADE!

Three times the cotton content (3 ply) of regular bands. Made with combed premium USA cotton. Very plush and comfortable. Your customers will love them. 100% cotton.

Merchandised in a smart, resealable package that allows your customer to feel and try on the band. Once they try, they are hooked. Available only in white and black.

- # UHB - 1 White headband
- # UHB - BK Black headband
- # UWB - 1 White wristbands
- # UWB - BK Black wristbands

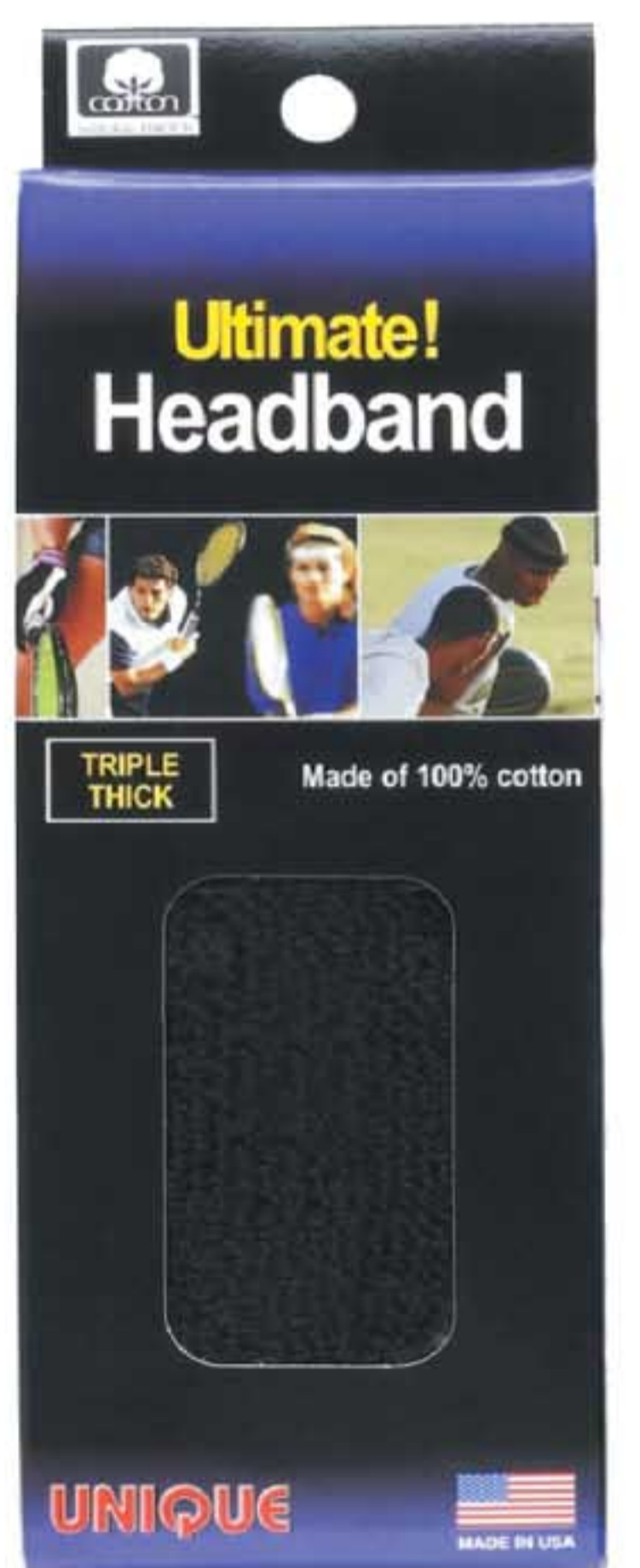
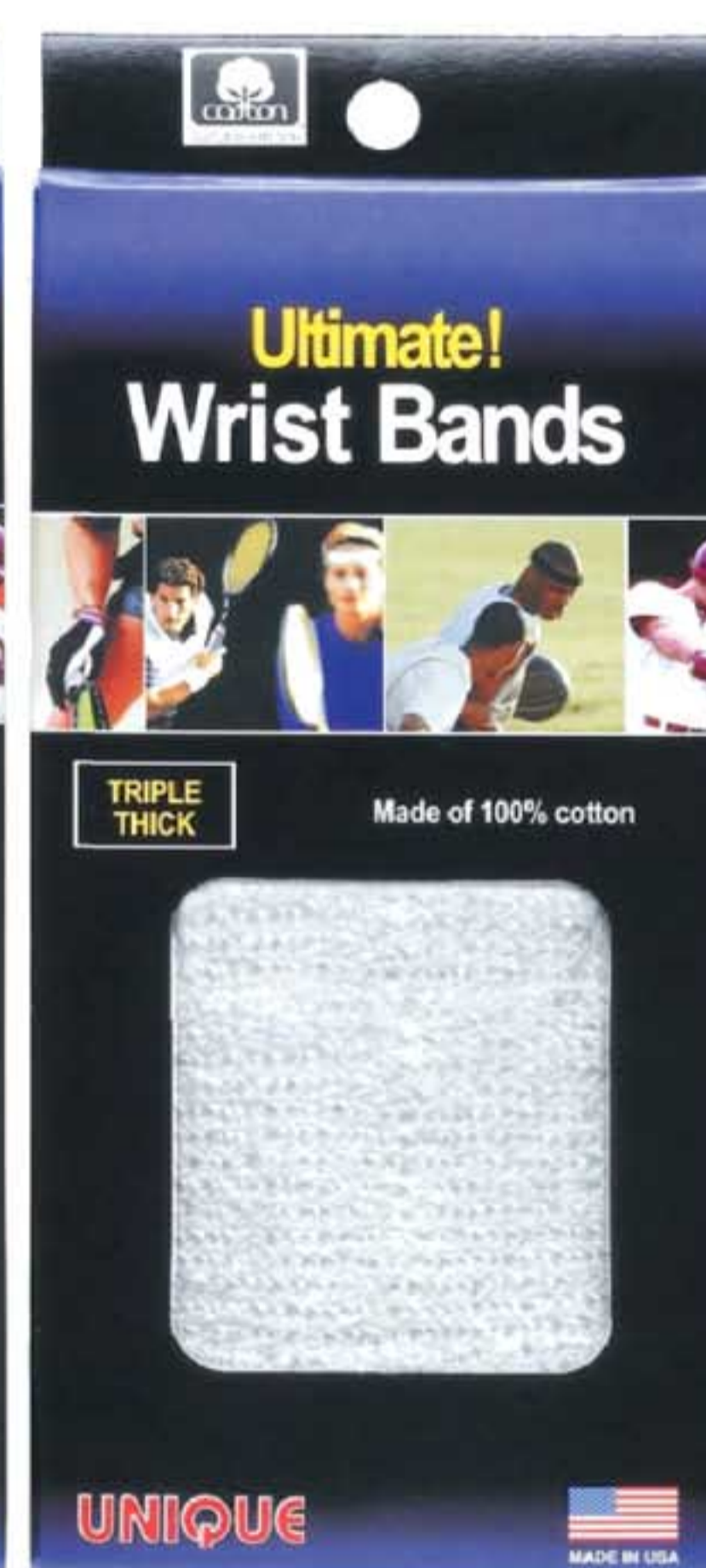
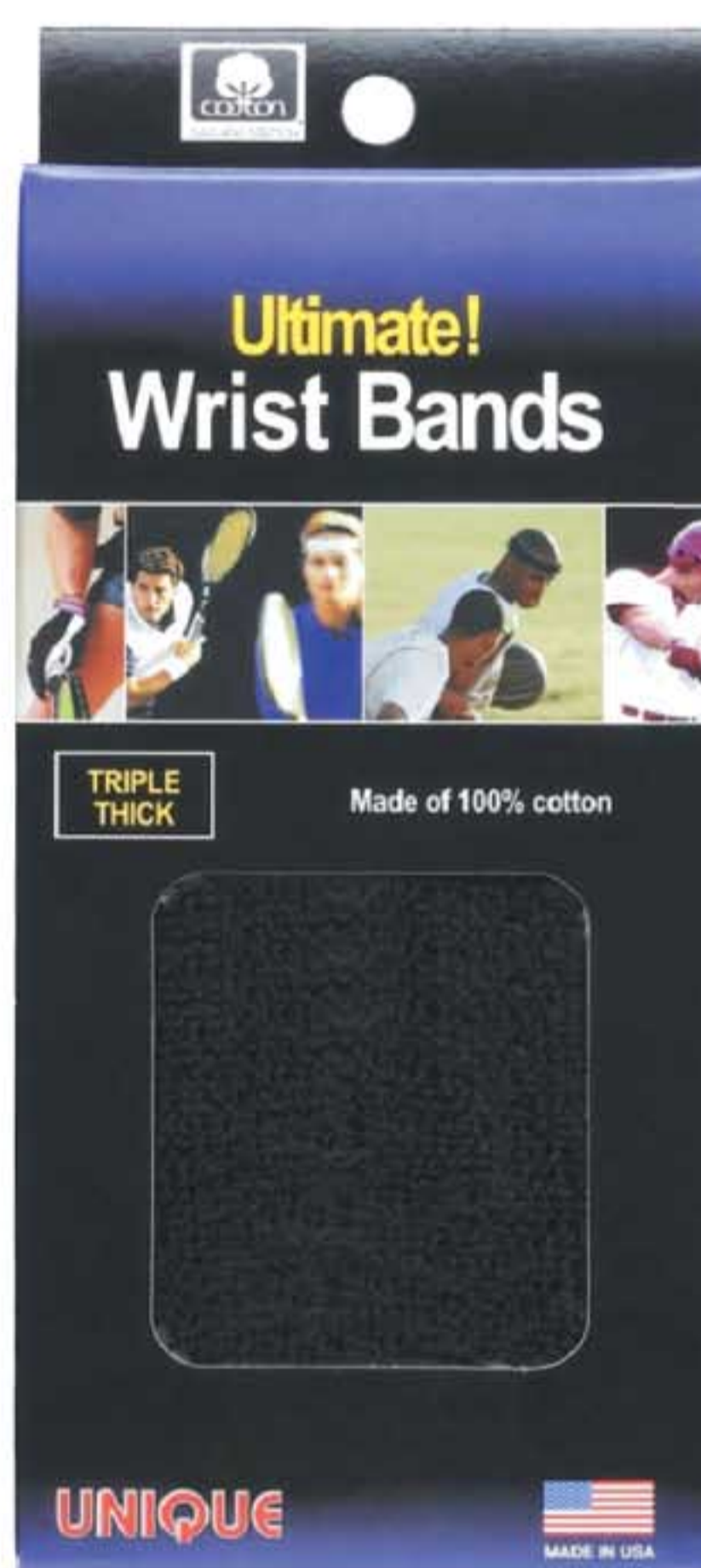

3 ply - The Ultimate Plushest Band

Yes, we knit our cotton sweatbands in the USA!

Our plant is located in Mt. Airy NC

(that's where they filmed the TV program Mayberry with Andy Griffith and Don Knotts).

We knit sweatbands made 100% and 94% cotton. The feel of cotton is simply unbeatable. We also knit Quick Dry cotton-poly blend that wicks moisture to the front of the band so it dries quicker.

We utilize non allergenic, recycled cotton in our bands. Helps save the planet and keep jobs in USA.



Sweat Bands

QUICK DRY



Top Seller!

2 per pack

2 per pack

High Performance Head & Wristbands

Hi Performance bands with 2 stage wicking action for maximum comfort.

Stage 1: Inner core is made with cotton/poly blend to wick sweat away from skin.

Stage 2: Outer wicking fibers pull moisture away from the cotton.

This two stage process maximizes drying and delivers cooling comfort.

Available in Black and White.



QUICK DRY



Clip Strip holds 12

Head & Wristbands

1 ply wrist and headband in poly bag. Cotton-Poly blend. Available in various colors. **Great price!**

Put them on a Clip Strip for blow out sale during hot summer months. Ideal for anyone working or playing in outside summer weather.

- # CHB-X Headband
- # CWB-X Wristbands

Available Colors:



6 pack

12 pack

Team Sweatband Packs

Each pack has 12 headbands or 24 wristbands. Great for teams, cheerleaders, and event promotions. **Great price.**

- # CHB - 12 Headbands - 12 pack
- # CHB - 6 Headbands - 6 pack
- # CWB - 12 Wristbands - 12 pair
- # CWB - 6 Wristbands - 6 pair

Available in these Colors:



6" long



QUICK DRY



WRIST TOWEL®

Our registered trade name, WRIST TOWEL, says it all. It's 6" long and very absorbent.

Made of non allergenic USA cotton, Quick Drying.

Consult price list for stock numbers.

- # WTL - X
- # WTL - 6-1 Team Pack of 6

Available in these Colors:



Bands

My Number Bands

Now a player can make his team number. Any numbers can be made from 1 to 99. Simply mark out the portion of the rectangle legs to create a desired number. See example below. **Permanent ink marker is included.**

MY-X (2 per pack)



Pen



"88" is embroidered on each band. After marking it becomes 18



1" Bicep Bands

Narrow biceps bands are the latest rage with players. They are only 1" wide. Made of non-allergenic 2 ply cotton yarn. Available in white and black.

1 WB-W White
1 WB-BK Black



Ultimate Bandana

This is the latest style of bandanna that tennis pros have made popular. Ties behind your head. Made of 100% cotton. Washable.

Available in black.

UB-BK Black



Sponge Bandana

Sponge is embedded in the forehead section of the Bandanna. No other band soaks up heavy perspiration like this one. On a hot and humid day it is absolutely incredible. Soak it in cold water and feel a magical relief. Made of cotton fabric. Washable and reusable. In white and black only.

SHB-1 White; # SHB-BK Black

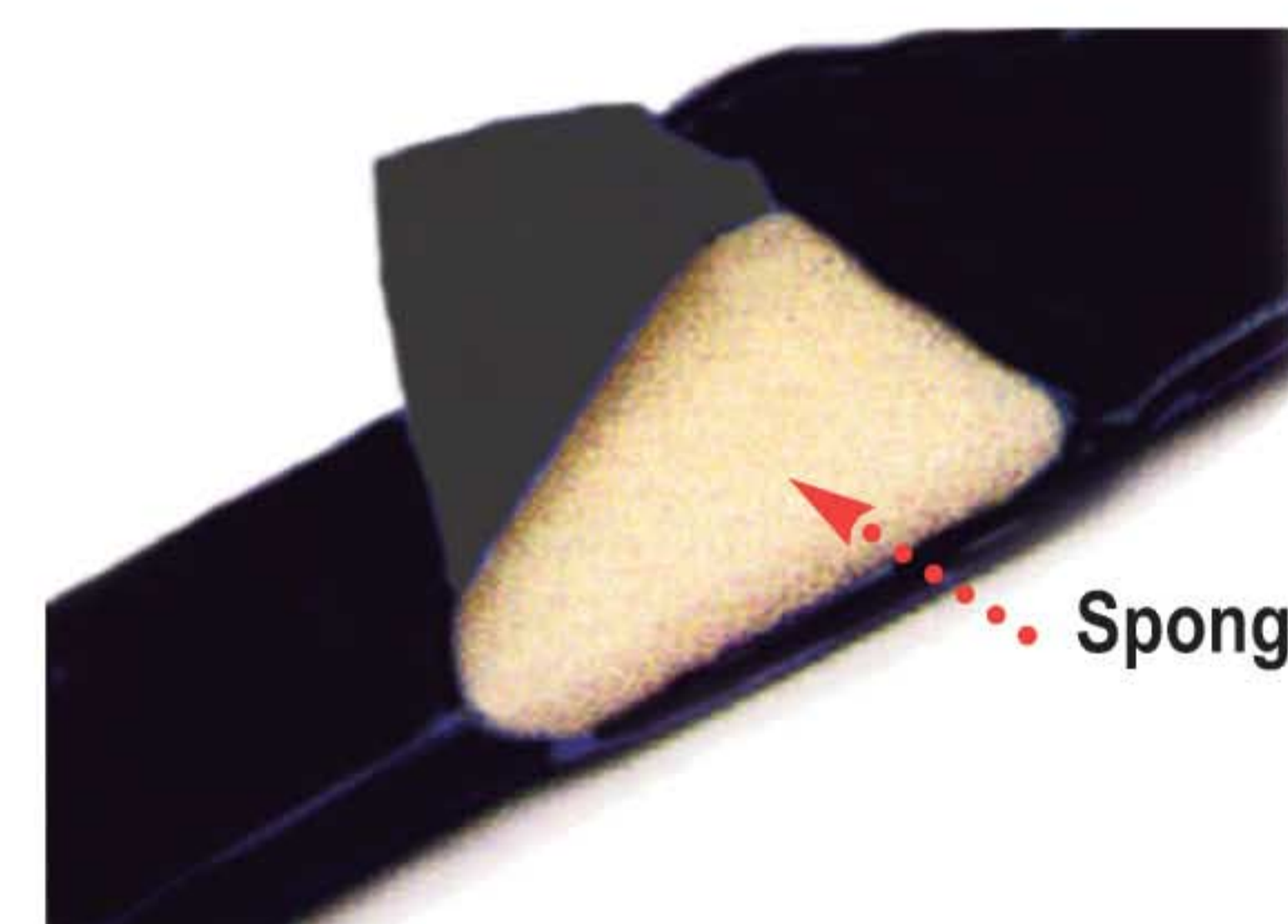

Sponge

Tourna® Tee's & Bands



TEE-T-S - Small
TEE-T-M - Medium
TEE-T-L - Large
TEE-T-XL - XL Large



Tourna Headband
Tourna Wristbands



HB-1T white
WB-1T white

Compression Arm Sleeve

Comfortable muscle support with sheer performance fabric. Fatigue is reduced and performance is improved. The fabric is feather light and feels like your second skin.

CARE: You can hand wash or machine wash.

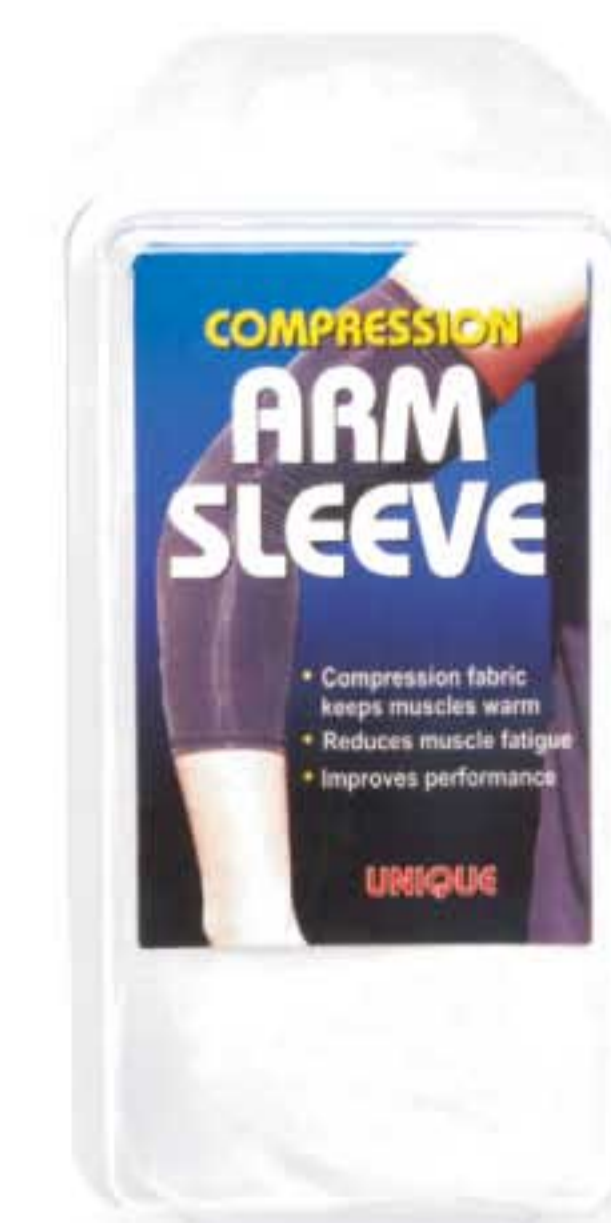

Colors and Sizes

ARM - L - BK, black ; # ARM - L - W, white Large / XL
ARM - M - BK, black ; # ARM - M - W, white Medium
ARM - S - BK, black ; # ARM - S - W, white Small
1 per package



Pete Sampras, the Hall of Fame, best USA tennis player ever. Pete won 14 Grand Slams; holds world record for # 1 ranking for titles (2nd all time high).

“Every title, every major I won, I used TOURNA GRIP. I could rely on Tourna Grip. It feels good in my hands. I think it’s the best grip out there”.

Pete Sampras



BOB and MIKE BRYAN have won so far 115 doubles titles...world record of all time. They have won 16 doubles Grand Slams, most ever; Davis Cup title; #110 times...most ever; Only doubles team to win Olympic’s Gold Metal; also won 4 consecutive grand Slams...Golden Slam; won 35 Masters 1000 titles, most ever. Truly an outstanding doubles team of all time.

MIKE : “We have won many titles from our junior, college and pro circuit. TOURNA GRIP has been with us every step of the way. We wouldn’t take the court without it.”

BOB: “Mike can have a bad day, I can have a bad day, Tourna Grip is never going to have a bad day. It plays well every time”.

Mike Bryan Bob Bryan

Embroiderery

Our US embroidery facility



Embroidered Logos & Promotions

We are your direct source with no middlemen. We knit sweatbands and embroider them directly in our plant. Call us and discuss your promo ideas (quantities at 144 minimum) are welcomed as well. We embroider headbands, wristbands, caps, visors, neck and ear Huggs and sport towels.



asi / 92582



Cap Embroidery

TOURANA

Can Cooler

Towel Embroidery



National flags on wristbands.
A great way to display country pride during sporting events. Wear it to Davis Cup, Soccer, Hockey, Basketball or during national holidays, parades, etc.

Made of 80% cotton, 10% nylon, 10% elastic.
Plush and comfortable and durable.
Measures 4" long. Two wristbands sold as a pair in a poly bag with header.



FBW-US USA



FBW-CA CANADA



FBW-BR



BRAZIL

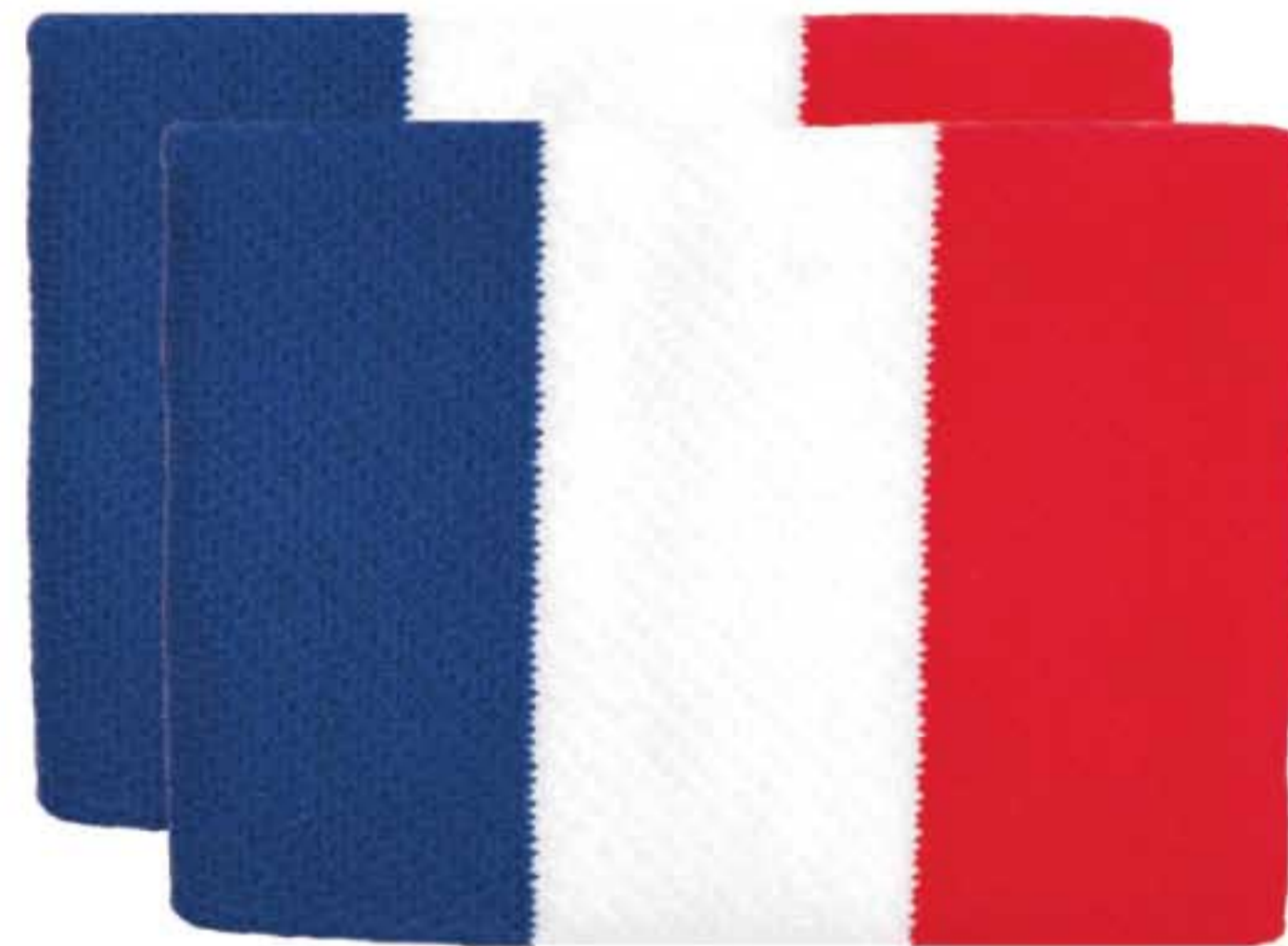

FBW-FR

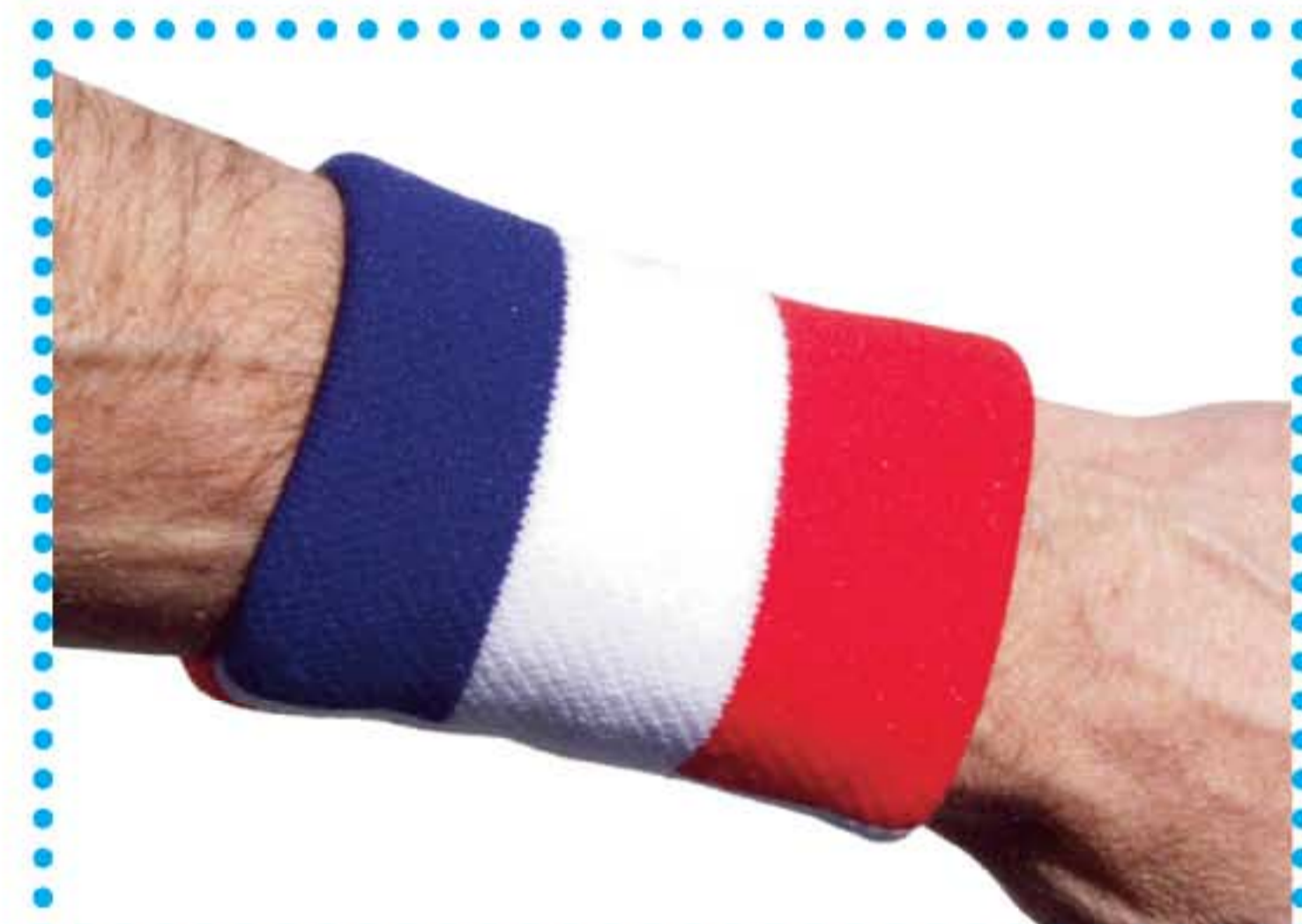

FRANCE



FBW-UK



GREAT BRITAIN



FBW-GR



GERMANY



FBW-IR



IRELAND



FBW-IT



ITALY



FBW-MX



MEXICO



FBW-SP



SPAIN

REFLECTIVE SAFETY PRODUCTS

On average, a pedestrian is killed by a vehicle every 90 minutes. And one is injured every six minutes. It is critically important to be seen at dusk and night. With our collection of safety products these needless accidents can be minimized. These products sell well in late fall.



Reflective Dash Vest

Wet or dry it reflects equally well for up to 1200 ft. Made of lightweight breathable mesh. The Dash Vest contours to your body for ultimate comfort and movement. Reflective strips are strategically placed in front, back and shoulders. Two Velcro tabs at bottom adjust the vest for perfect fit.

One size fits all.

RSV-D



Deluxe Reflective Vest

- Soft mesh conforms to body.
- Vertical and horizontal reflective stripes are in front and back of vest.
- Zipper pocket in front for key and ID
- Back of vest is cut higher for better fit.

Wet or dry you can rely on the reflective safety it delivers. The extra reflective stripes make for superior visibility.

DRV-1



Top Seller!



Reflective Vest

Wet or dry it reflects equally well for up to 1200 ft. Made of lightweight breathable orange mesh with one reflective stripe in front and one on the back in a diagonal position which delivers maximum reflective visibility. One size fits all.

RSV-X Poly bag pack



Reflective Cap

Reflective trim on bottom of cap brim makes one visible at dusk and at night. The cap mesh construction makes the cap very cool to wear. Plush inner headband soaks up moisture from forehead. Washable and durable. These are good looking caps that makes you stand out for added protection from traffic.

RCAP-S Silver reflective trim

RCAP-O Orange reflective trim (with Unique logo)

SAFETY PRODUCTS



Flashing Reflective Band

Just fasten around arm or leg. Brilliant lights can be set to either permanent or blinking flash. The flashing will be seen up to 3000 feet. The band also reflects light from oncoming vehicle headlights. It will run up to 250 hours of continuous use. Comes with a replaceable V Lithium battery.

FRB-2



Flashing Safety Light

Blinking light with adjustable arm band. Wear it on arm -- visible up to 3000 feet.

It emits a brilliant L.E.D. flashing light. It has multi-function flash settings for different blinking patterns or just to stay on. It is also designed to clip to waistband for those that don't want to place on arm.

Uses 2 AAA batteries (not included).
Case is weather sealed for inclement weather use.

BL-2



Flashing Bike Light

Attaches to back of bike under the seat. Comes with mounting bracket. Has multiple flashes that can be programmed. Will be seen up to 3000 ft.

Uses 2 AAA batteries (not included).
Case is weather sealed.

BL-3

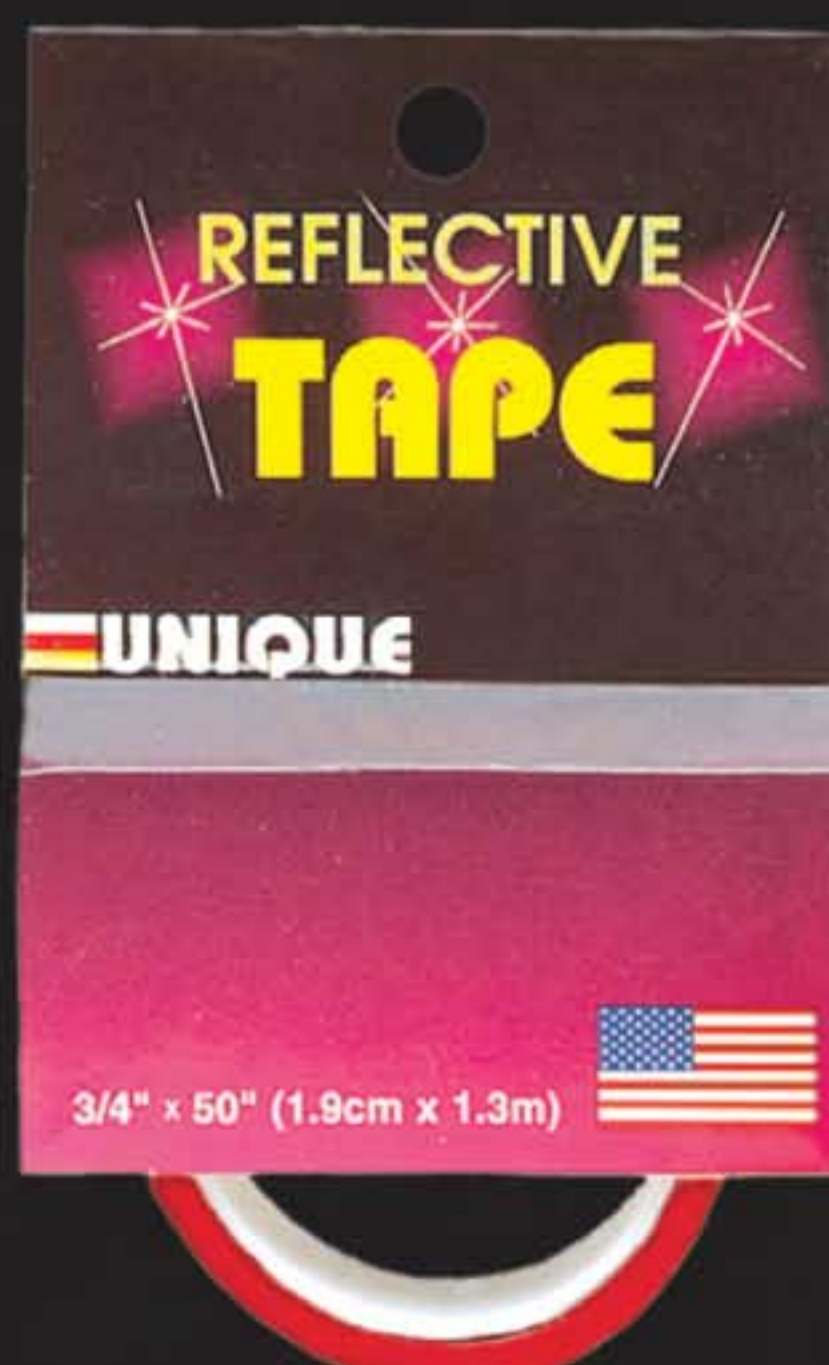

Reflective Tape

This is a highly reflective tape. Simply peel, cut and stick on any hard surface. Self adhesive on back of reflective tape. Place on helmets, bikes, car, mailbox, etc. Available in optic white, yellow and red. Size: 3/4" x 50 inches.

RT-X 1 roll/package
RT-3 3 rolls/package

SAFETY PRODUCTS

Reflective Wrist Wallet

Waterproof zip lock wallet that fits on wrist. Water resistant material on outside with soft cotton terry on the inside facing the wrist. Holds ID, keys.

Colors:
Red
Black
White

RWA-X Adult
RWA-J Junior



Kids Wrist Wallet

Waterproof zip lock wallet that fits on wrist. Water resistant material on outside with soft cotton terry on the inside facing the wrist. Holds ID, keys.

Colors:
Black, Blue, White, Red
WWA-J Junior



HALT! Pepper Spray

Hot Pepper Spray formula is safe, but very effective. Aerosol can shoots a stream 10 ft. long. It will stop an animal or mugger in its tracks. Clips on belt or waistband. Halt brand is carried as protection by US mail carriers.

DR-1
DR-1-PROD - Bulk 12 pack



Reflective Dog Leash

Your pet and you will be safer at night. Your pet will be seen up to 1200 ft.

Leash adjusts to 54" length. Stainless steel collar lock securely. Very durable construction.



Shoe Pouch

Quickly and easily attaches to the top of sport or skate shoe. Holds money, key, ID, medical information. It can also be secured to belt. Great for kids.

SHP-X Assorted



Clip Wallet

The hidden wallet clips to waistband or belt. Place it on the inside of pants. The clear clip can barely be detected by anyone. Ideal for travel, beach, etc. Carries ID, credit cards, keys, \$\$.

CLW-1 Assorted colors
(black, red, white, blue)



GOLF Accessories

Premium Wood Tees

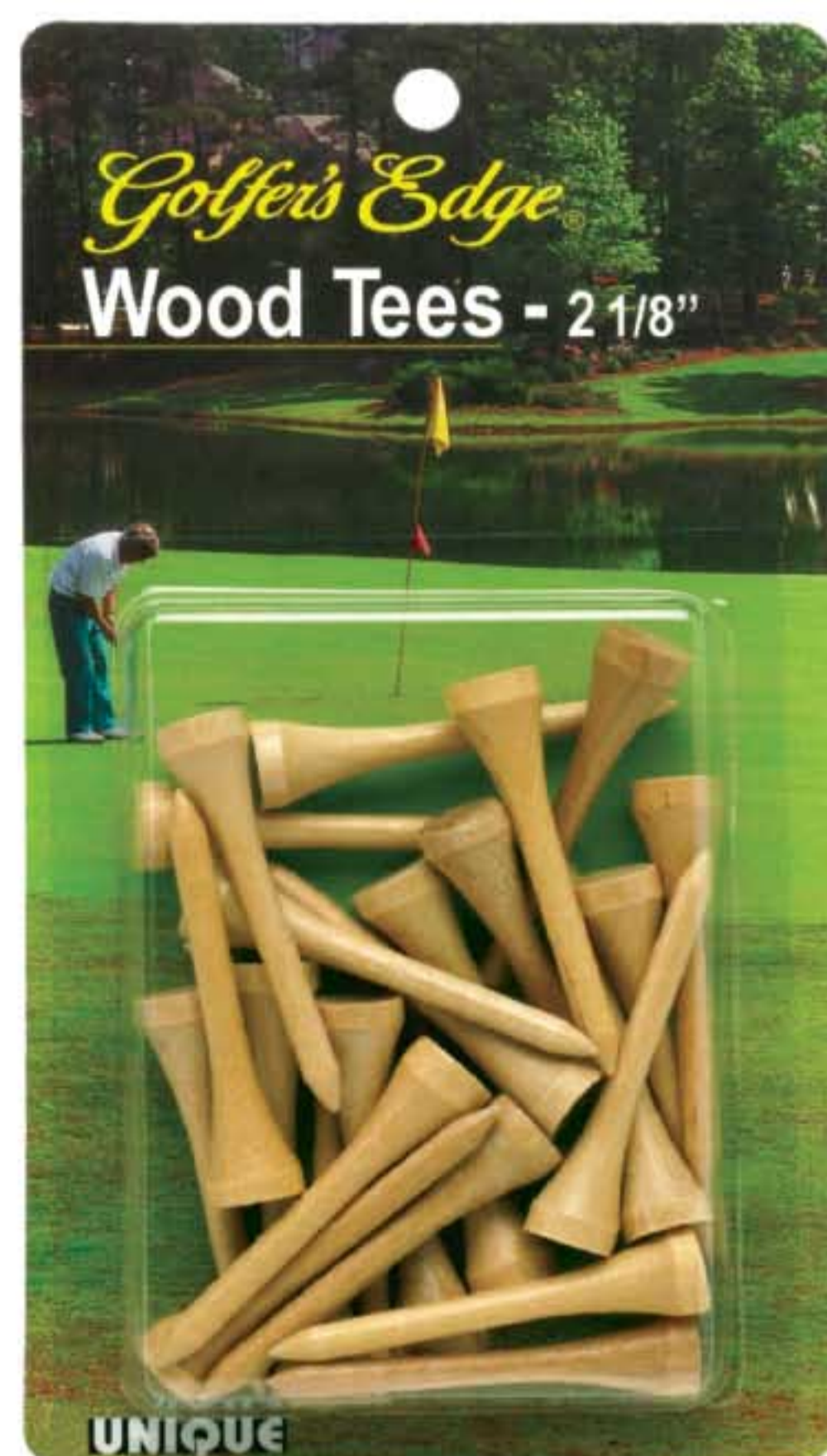

2 1/8" Hardwood tees in natural wood color.
927

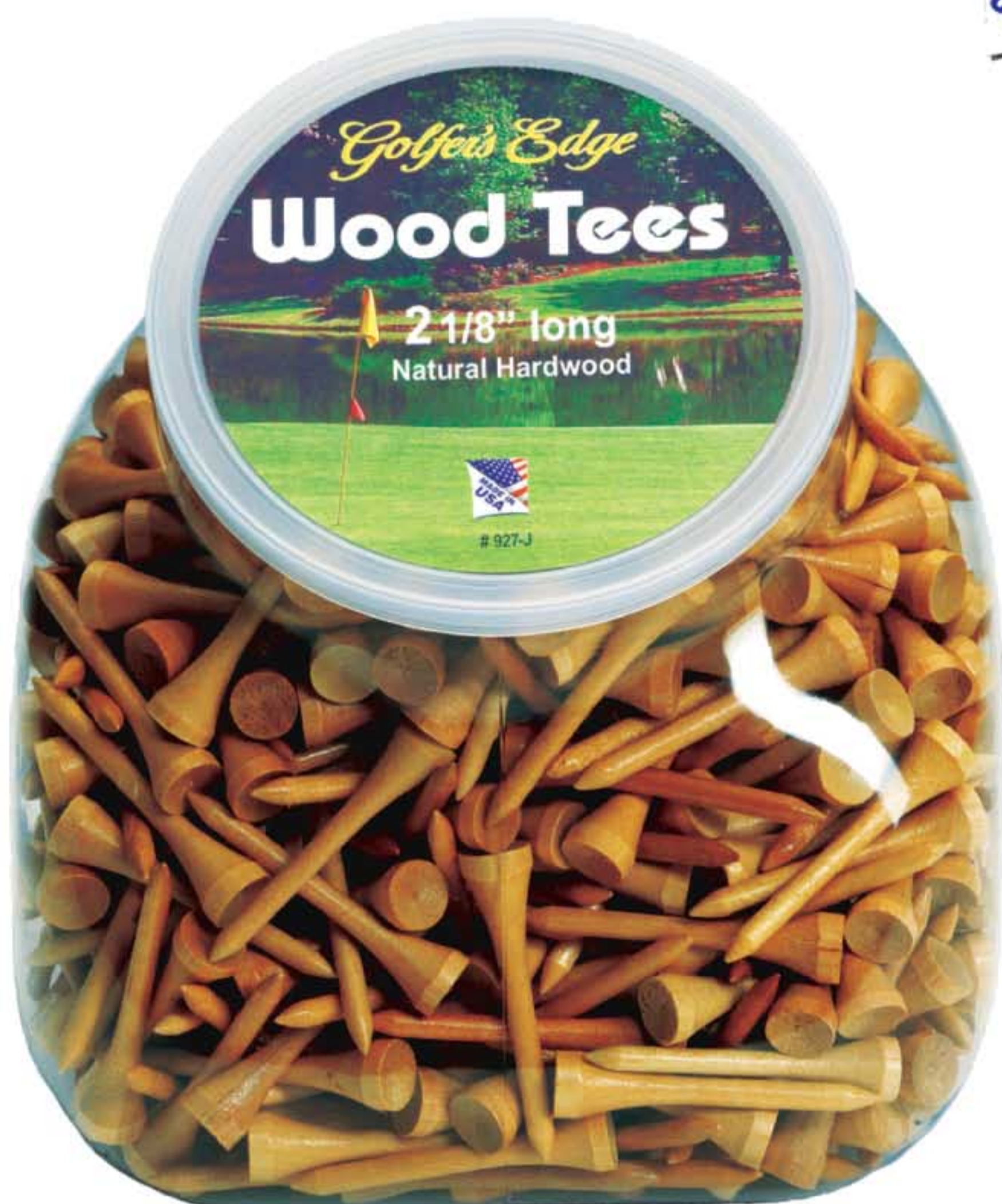

JAR holds 650 2 1/8" tees.
Sell by the handful.
927-J



Carry Pouch holds 180 2 1/8" tees
927-P



Golf Pencils

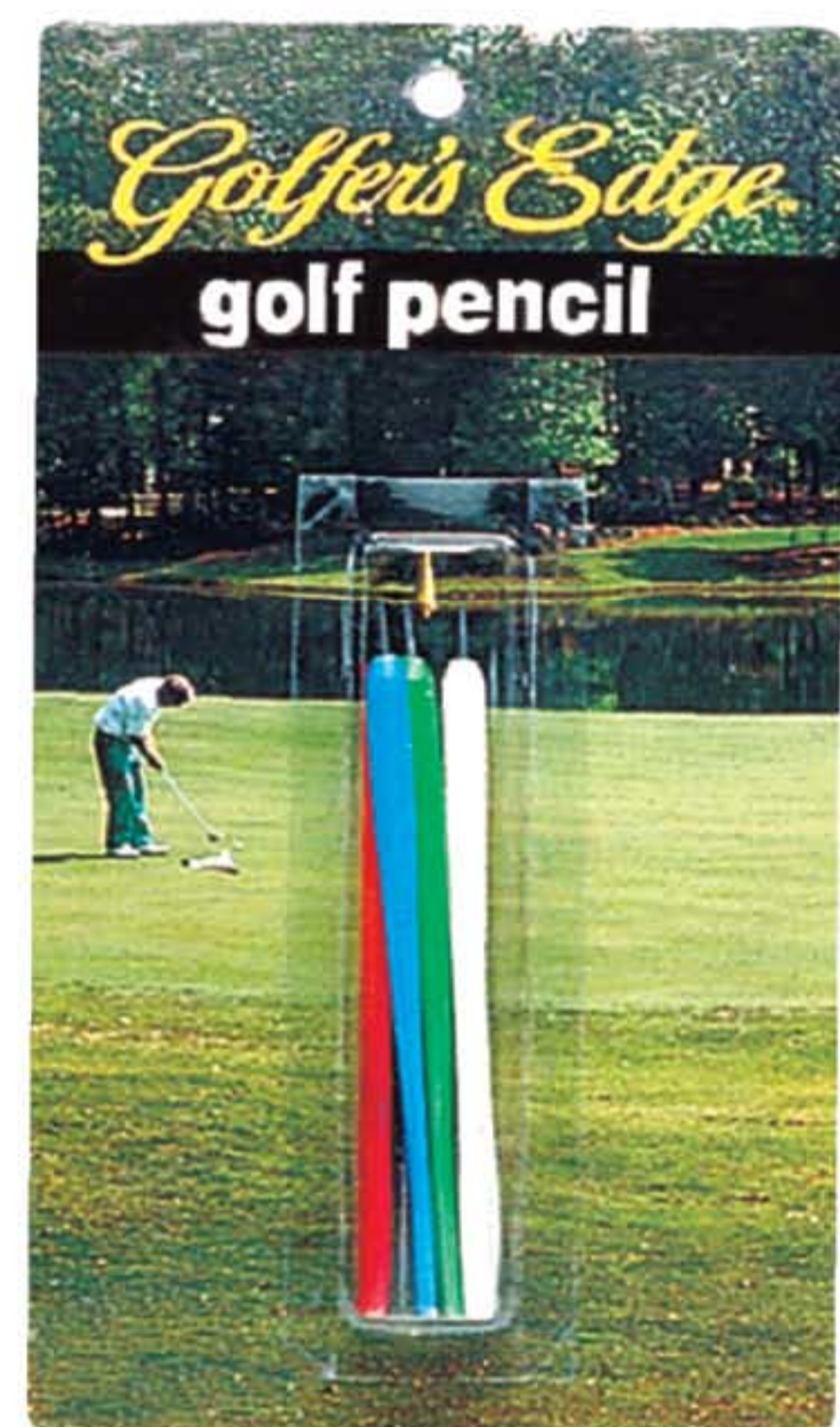

Plastic shell with lead point.
Clips to scoreboard.
4 pencils per pack.
914

Putter Holder

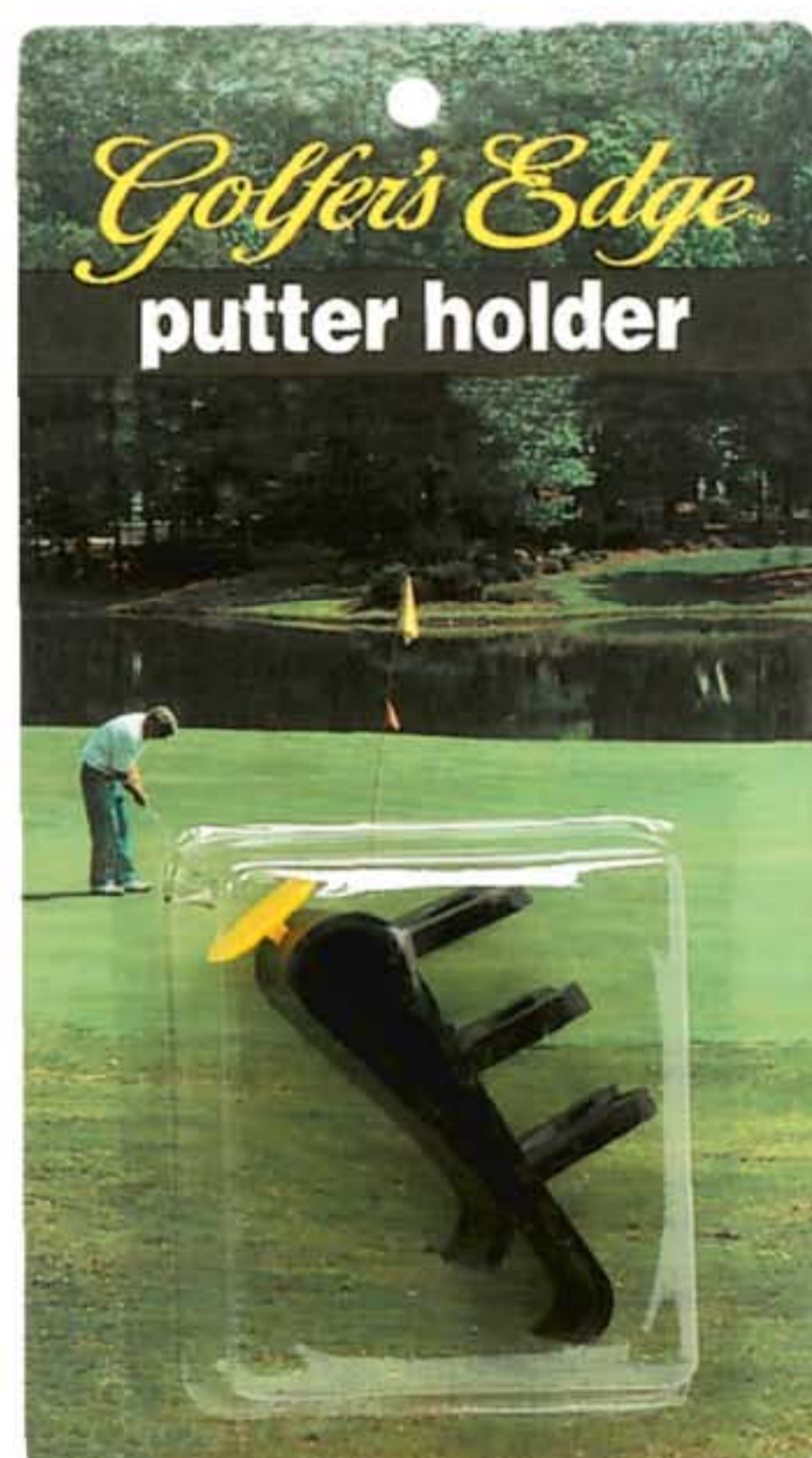

Putter holder clips to golf bag for easy access.
Millions sold.
985

Ball Spotters

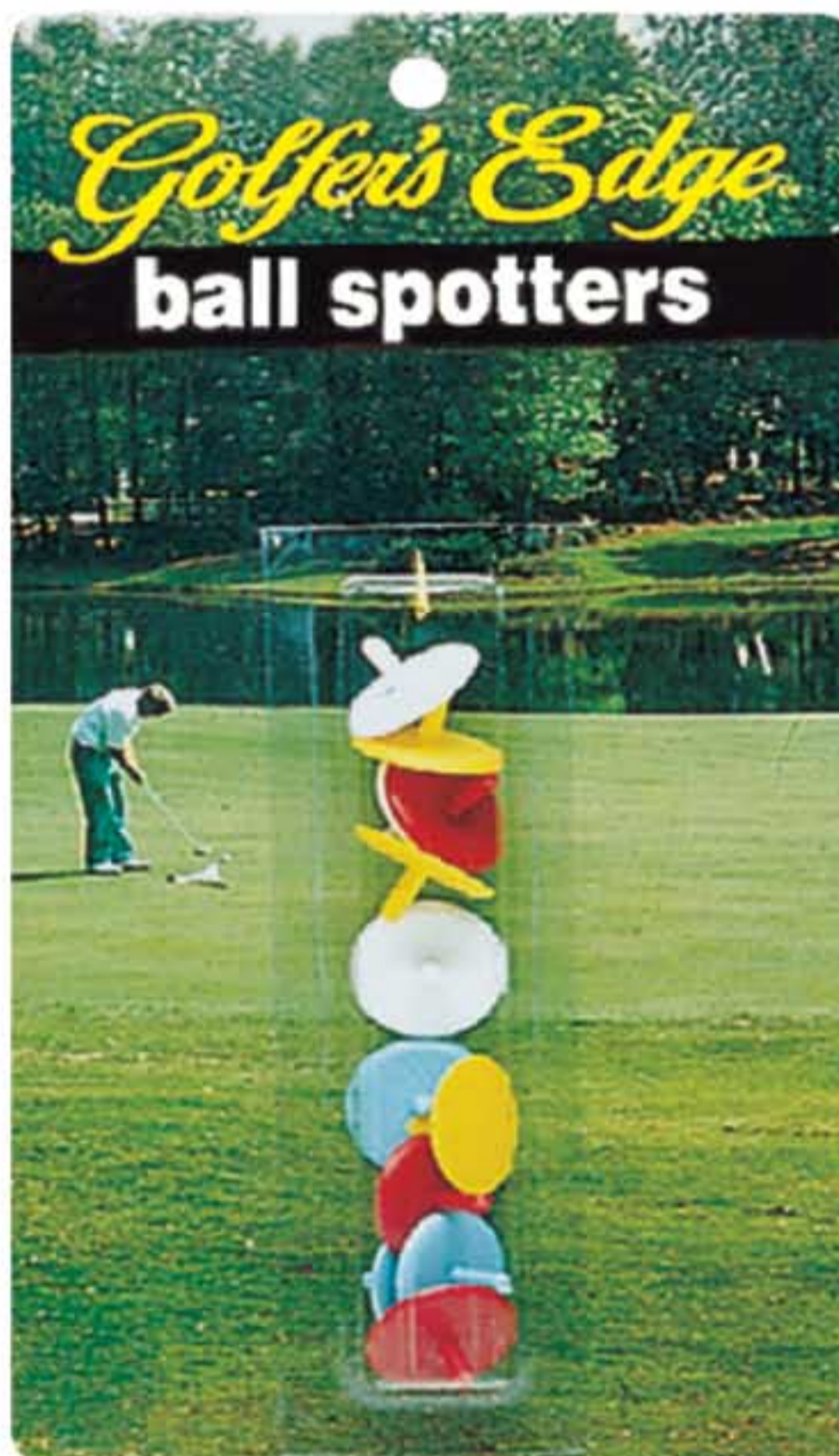

Made of bright color plastic so you can see it.
12 spotter per package.
950

Accessory Kit

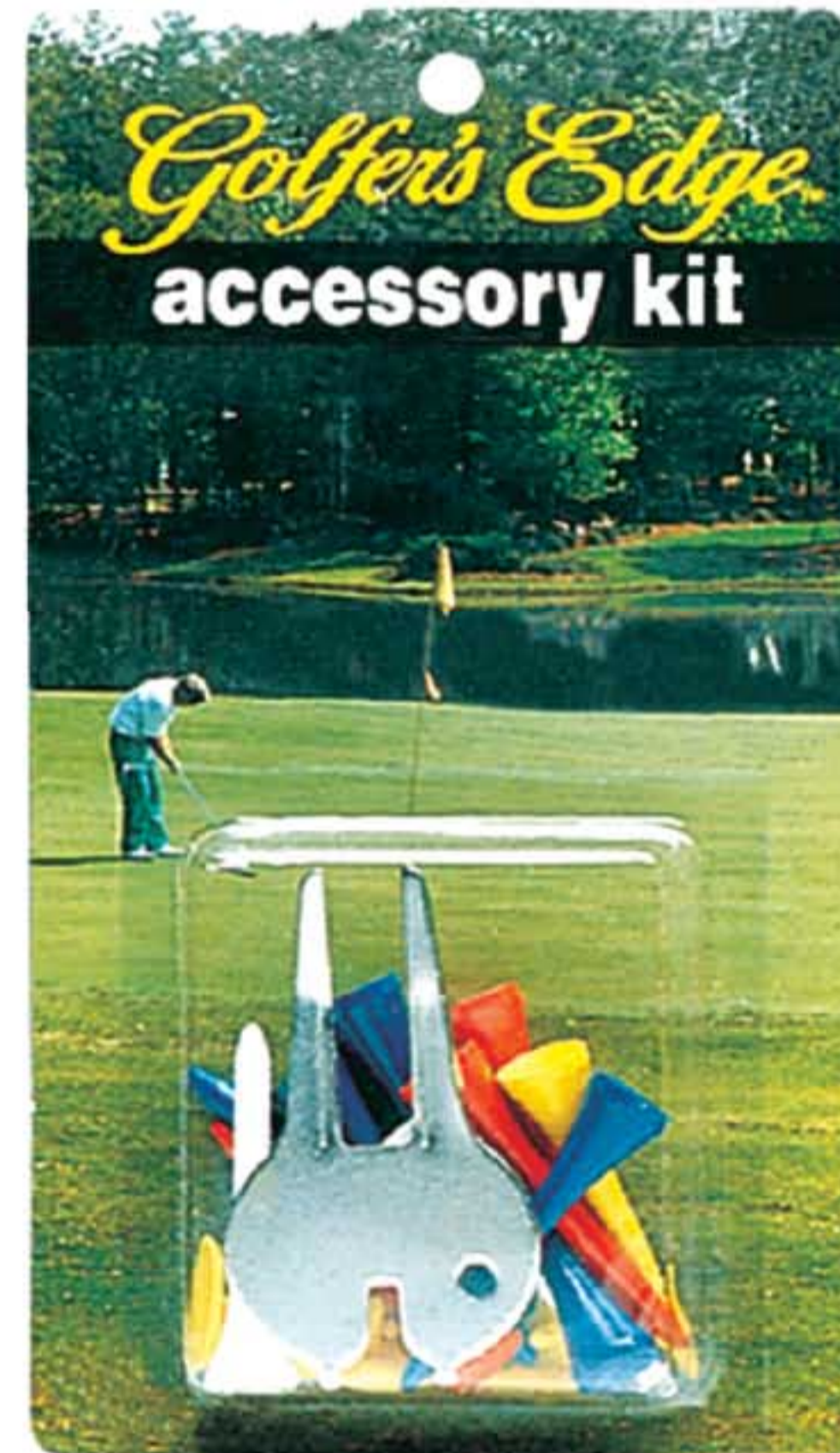

Contains 12 wood tees, 6 spotters, divot digger and spike wrench.
954

Tee Caddy

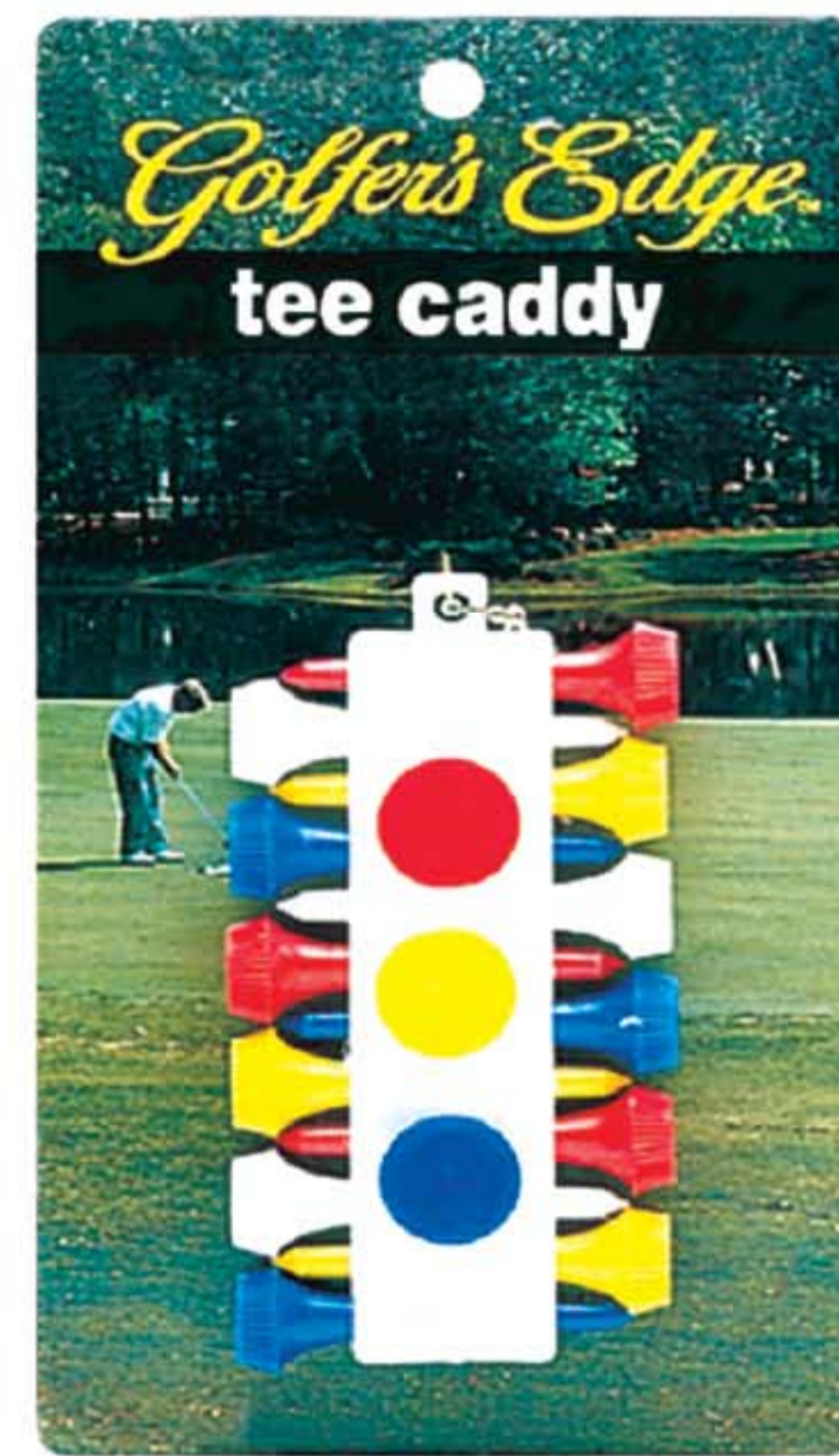

Holds 12 plastic tees and 3 ball spotters.
Attaches to golf bag.
959

Deluxe Spike Wrench



Spike wrench will remove rust-bound spikes. The handle is covered with thick plastic so it grips well and provides leverage.
931

Spike Wrench



Very light and compact for emergency spike repair or tightening.
938

Divot Tool

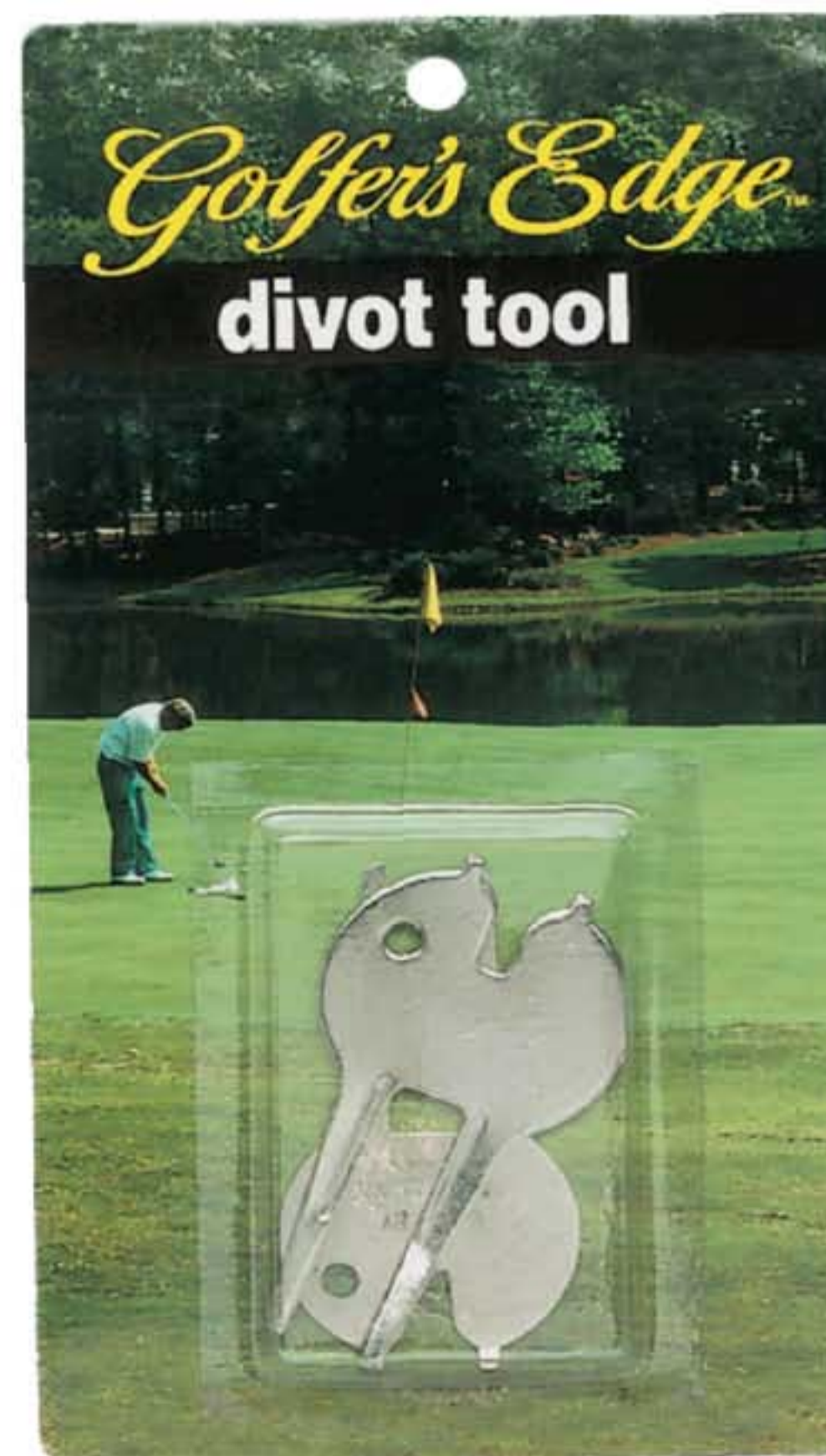

Use it for green repairs and spike tightening. Two per package.
939

Lead Tape

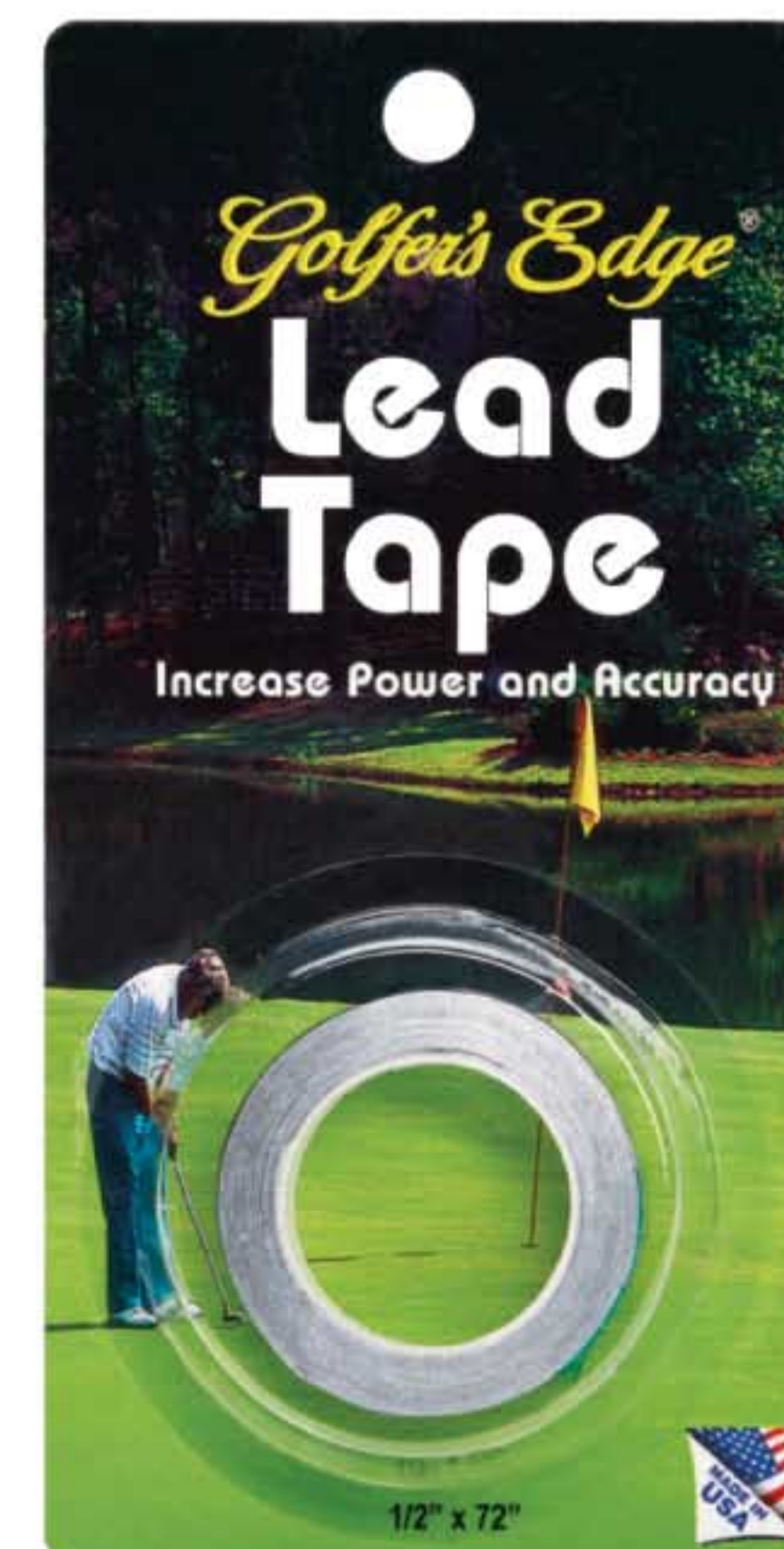

Adds power to clubs. Just cut and tape as per directions on card. It works and it's legal.
934

Valet Brush



Shoe horn handle brush with stiff bristles for thorough cleaning. Spike wrench is built-in at top of brush. It also cleans spikes. # 915

Brush & Tool



Cleans spikes, shoes and clubs. Folds neatly into compact tool. Elastic cord attach to bag. # 962

Score Counter

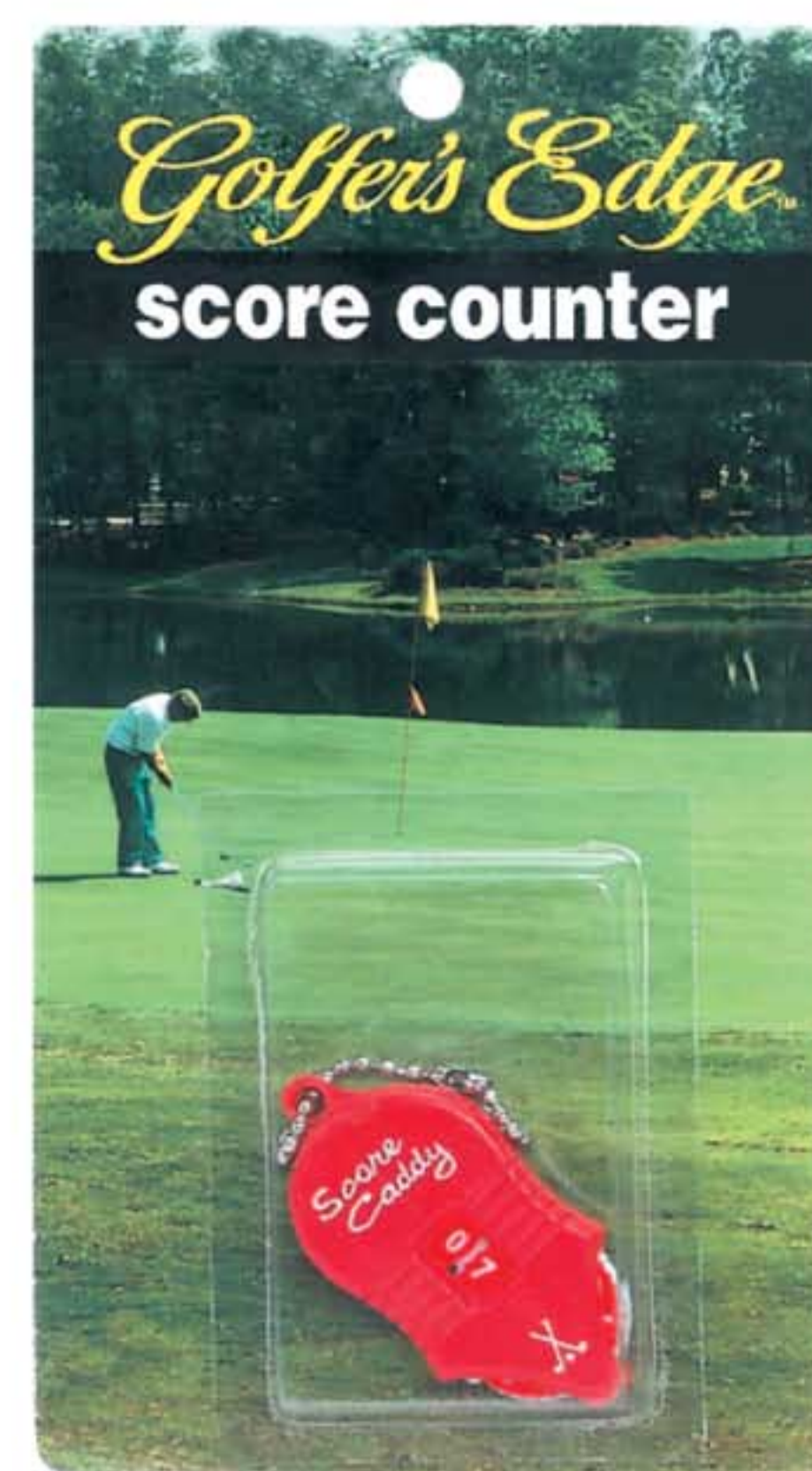

Keeps track of all strokes. Hangs on belt or golf bag. So small that you can carry it in your pocket. # 967

Putting Cup

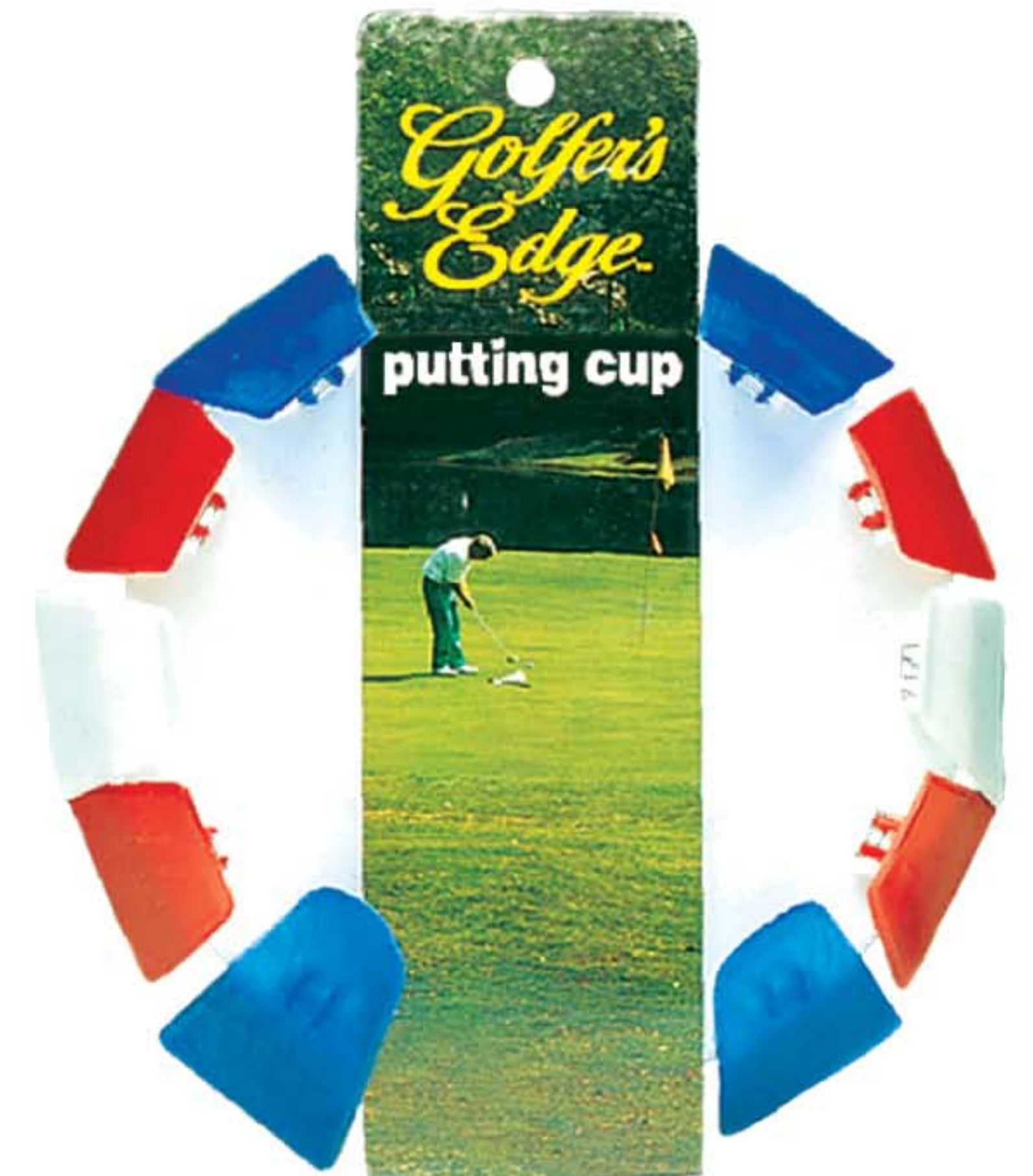

Lightweight plastic cup fits flush on surface. Practice putting at home, office, garage, basement or lawn. # 965

Plastic Practice Golf Balls

Practice Balls With Holes

Made of durable plastic. Designed to simulate ball flight. Exact size as official golf ball. Used for practice.

- # 941 Practice balls with holes - 6/bag
- # 942 Practice balls with holes -12 per bag
- # 942-C Multi color mesh pack, with holes - 12 pack
- # 942-80 Mesh carry bag of 80 balls with holes



Dimpled Practice Balls - No Holes

Made of durable plastic. Designed to simulate ball flight. Exact size as official golf ball. Used for practice. Solid on the outside but hollow on the inside)

- # 946 Dimpled hollow practice balls 6/bag
- # 947 Dimpled 12 per bag
- # 947-80 Mesh carry bag with 80 dimpled practice balls



Coin Holder

Made of brass. Golf club is gold plated. Can be engraved for trophy or gift.

UG-16



Letter Opener

Gold plated. Made of brass. Unusual and desirable gift.

UG-1

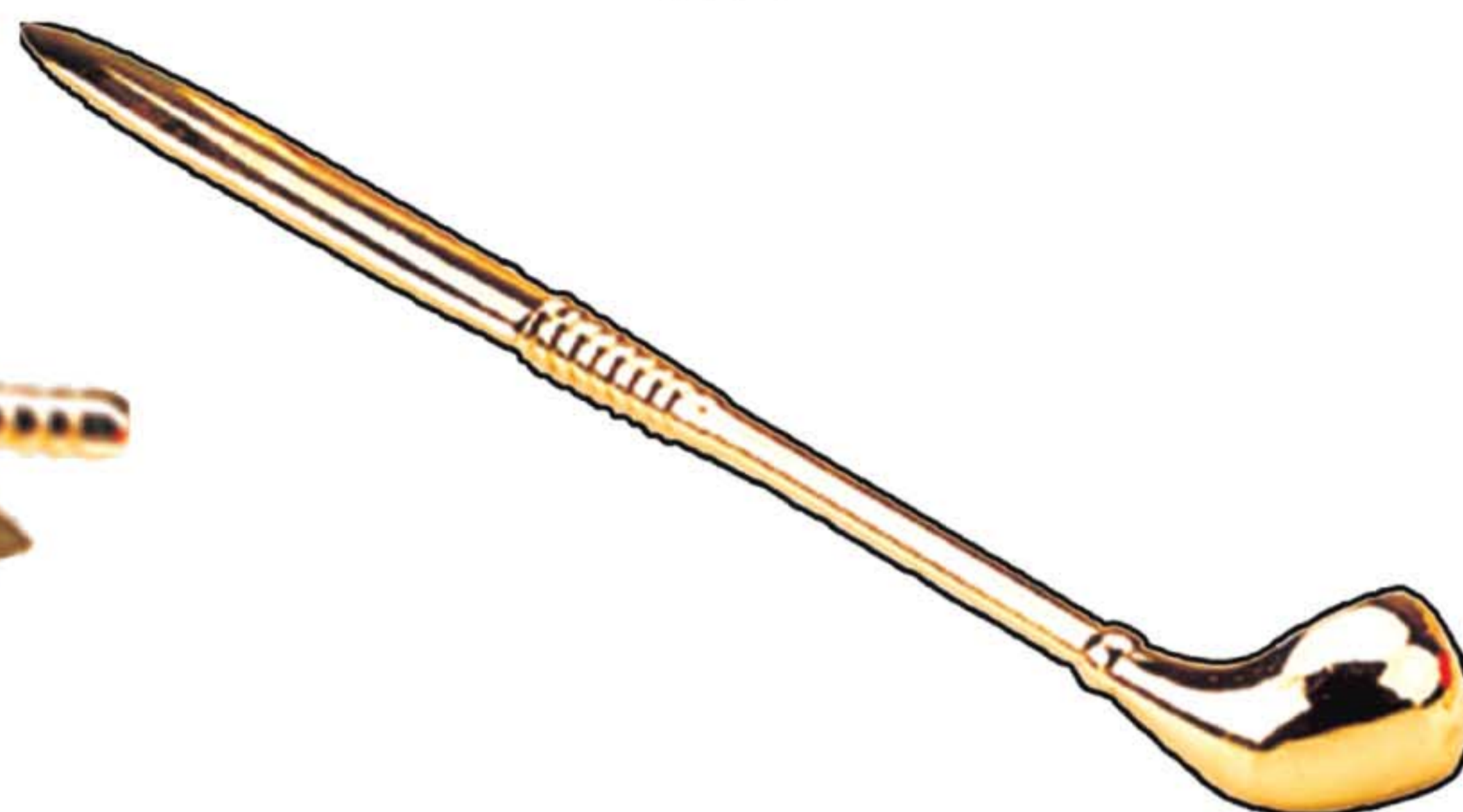

Letter Holder

Nickel plated brass with gold plated golf club. Engraved it makes an elegant gift or trophy.

UG-8



Business Card Holder

Gold plated. Elegant business card holder. A very unique gift for golfer.

UG-19



Business Card Holder with Pen

Gold plated. Elegant business card holder with pen. A great gift for golfer.

UG-18

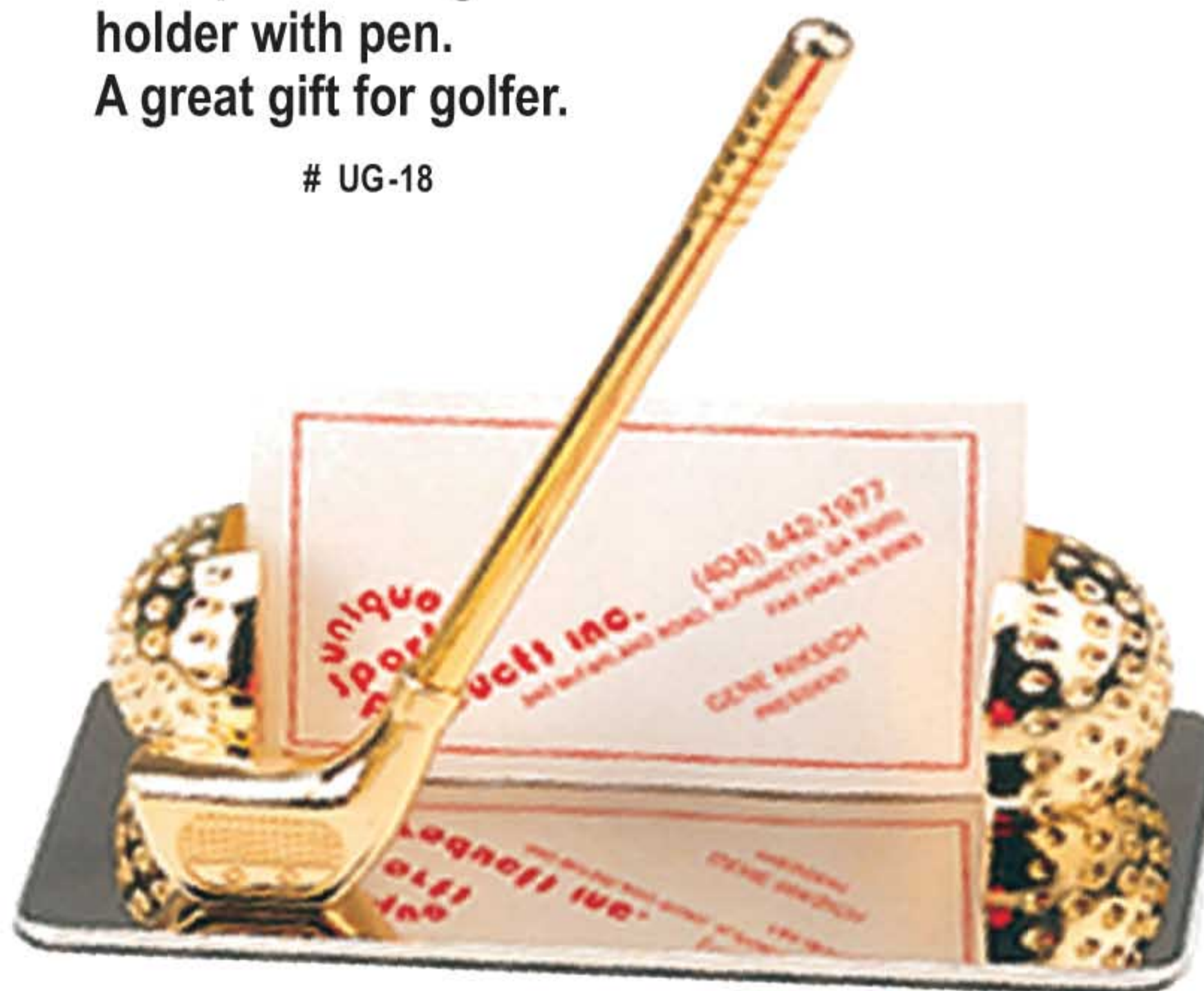

Key Chain

Miniature golf ball replica with key ring. Golfer's key holder.

SK-G



Nut & Bolt Trophy

Nut & bolt design of golfer. Makes for a great trophy or golf gift. Made of metal with bronze finish.

Dimensions:

2 3/4" diameter base, 8" high. Base can be engraved.

NBG-1



Golf Glove Shaper

Prevents glove shriveling from hand perspiration. Glove dries quicker after play and in the correct shape.

GS-1 (6/cs)



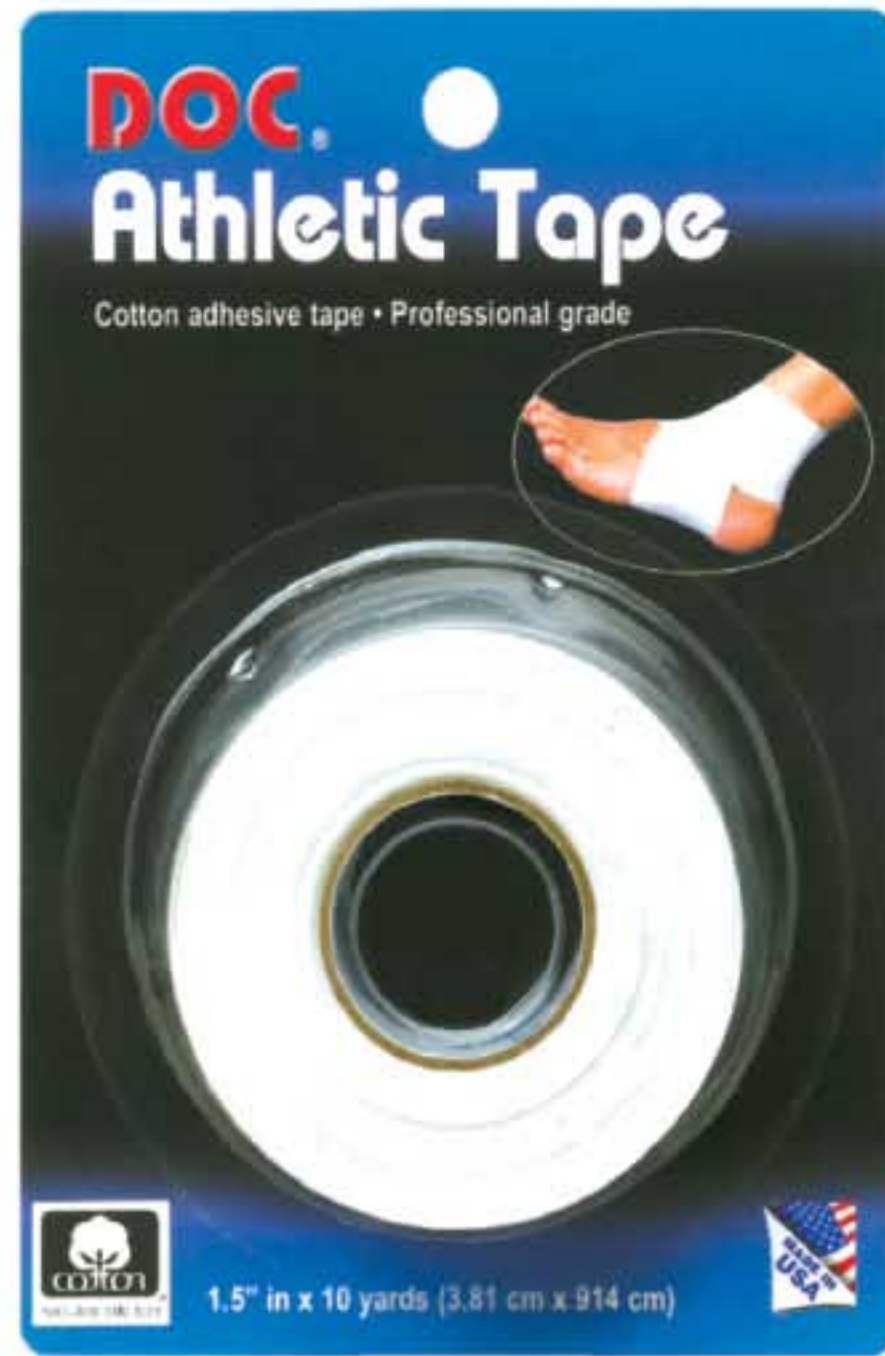

Athletic Tape

This is a high quality, cotton, breathable tape. It is used to protect injured joints. Athletic trainers, professional players and weekend warriors rely on it.

Size: 1 1/2" x 10 yards.

AT-1 White



Elastic Bandage

Made of cotton and elastic. Assures excellent stretch to achieve compression. A time tested remedy for sprains and muscle strains.

Size: 3" x 4.5 yards.

EB-3

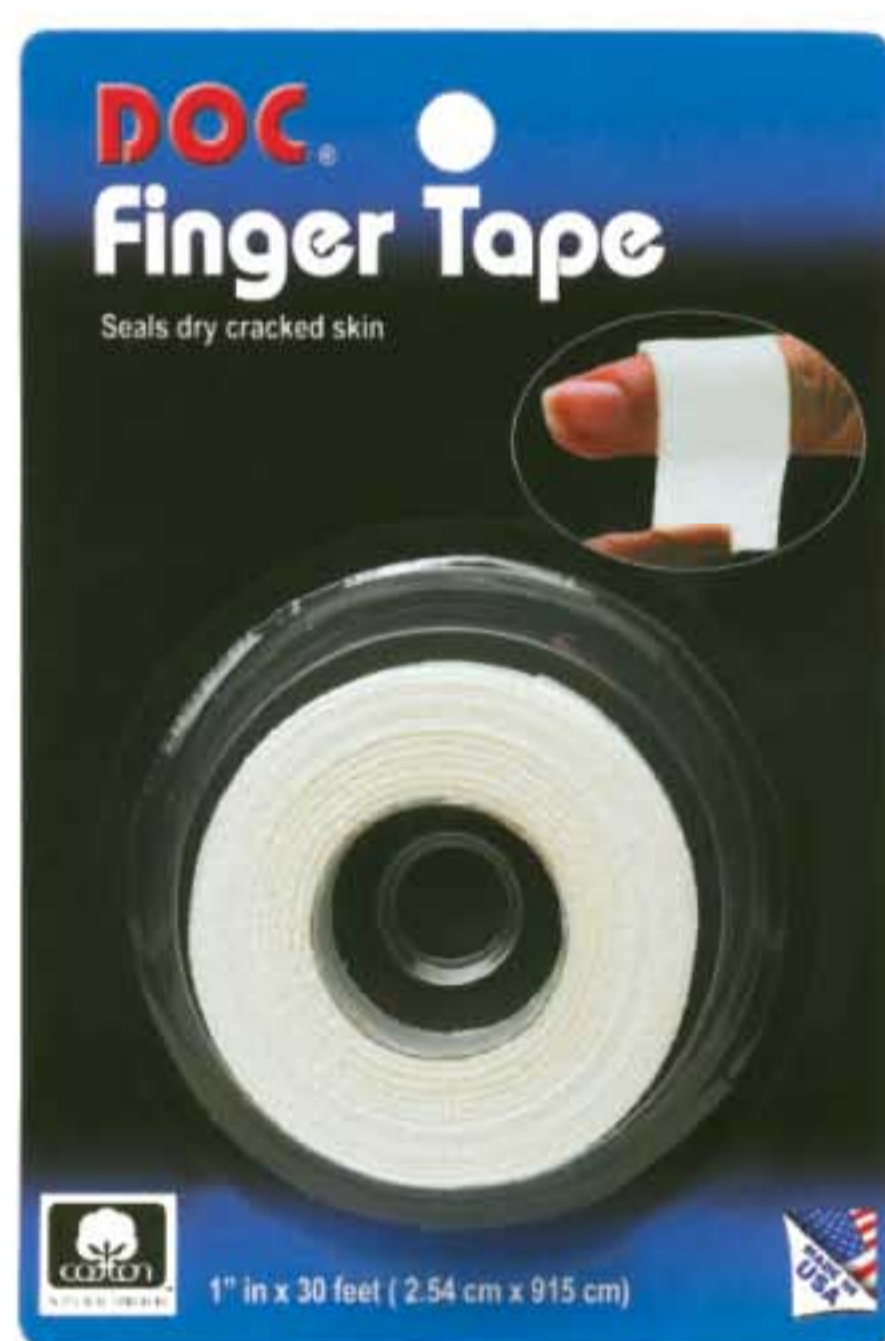

Finger Wrap

Very thin and porous cotton mesh which sticks to itself when wrapped over. It promotes healing of cracked skin on fingers. Dry skin causes most of the skin cracks. This unique material breathes and this promotes faster healing.

Roll is 30 feet long.

FW-1 White



Wrist Support

Features a thumb restraint to keep the support in place. Elastic construction allows desired pressure application to wrist. One size fits all. Wash in cool water.

WS-1



Wrist Control

Supports weak or injured wrist. Made of elastic with Velcro closure. One size fits all.

WC-1



Fingerling™

Excellent hand strengthener. 3 Finger Resistance Tensions

Place around each finger and stretch out as far as you can. Hold the stretch to a count of 5...release and repeat. # FING-3



RECOMMENDED FOR:

- Recovery from fractured or broken wrist, tendon surgery
- Suffering with rheumatoid arthritis
- Painful tennis elbow or golfers elbow
- Weak hand grip
- Will help prevent injuries

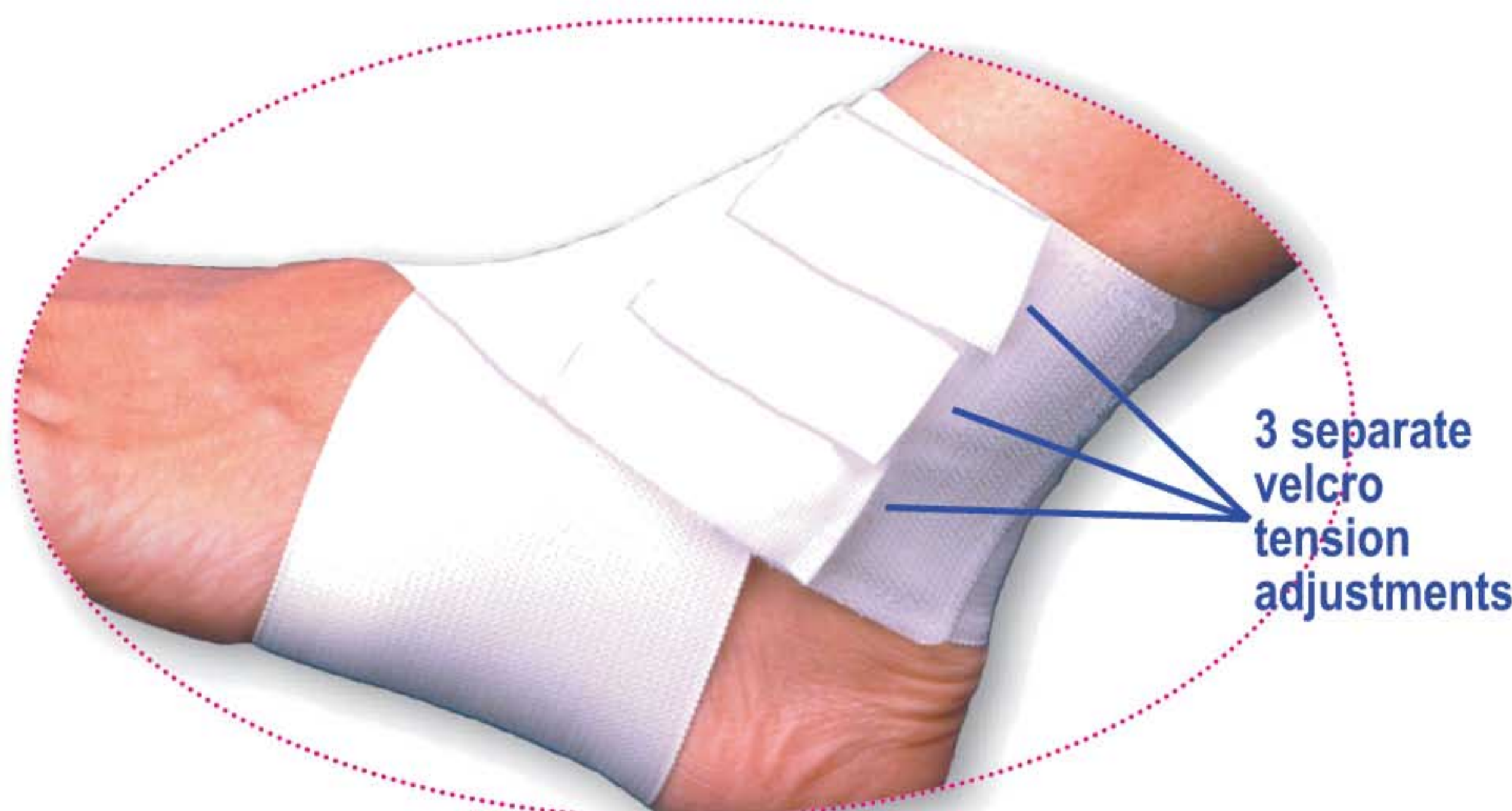

Ankle Support

Wraps around ankle for immediate support. There are three independent strips that pull the elastic wrap. This provides precise pressure to the injured ankle area.

Available in small, medium and large.

DAS-X (S, M, L)



Knee Strap

Fits directly below the knee cap. Reduces pain in the knee by applying uniform compression on the tendon below the knee cap. This constant pressure improves the patella tracking and elevation. It is made with stretch material with Velcro closure. One size fits all.

KST-T

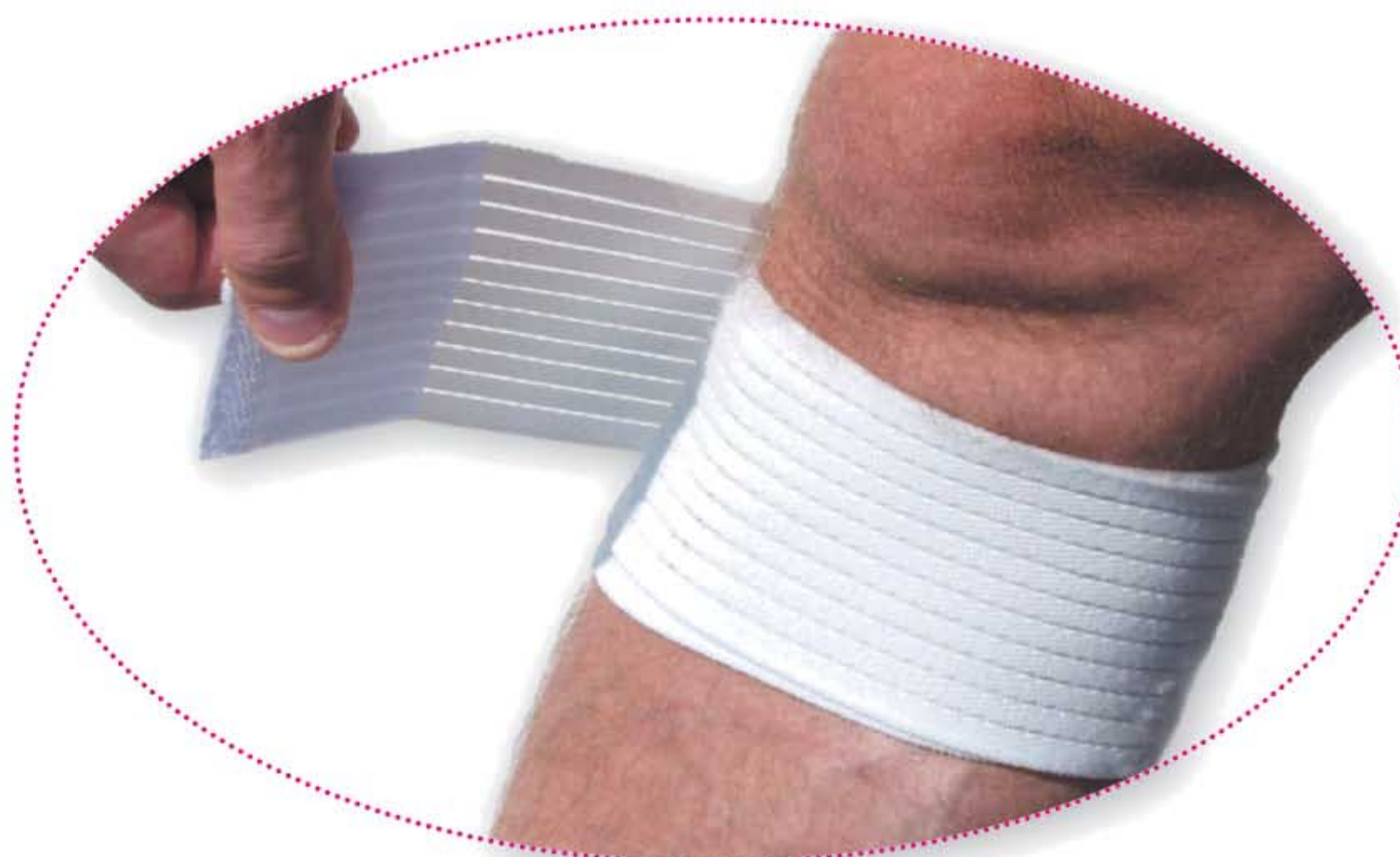

PRO Wrap

The ultimate compression wrap. It allows you to control the compression and support. This extra strength (3"x 30" long) elastic wrap is constructed with breathable nylon wool fibers and elastic. Comes with Velcro closure. Durable and reusable. One size fits all.

DPW-1 White

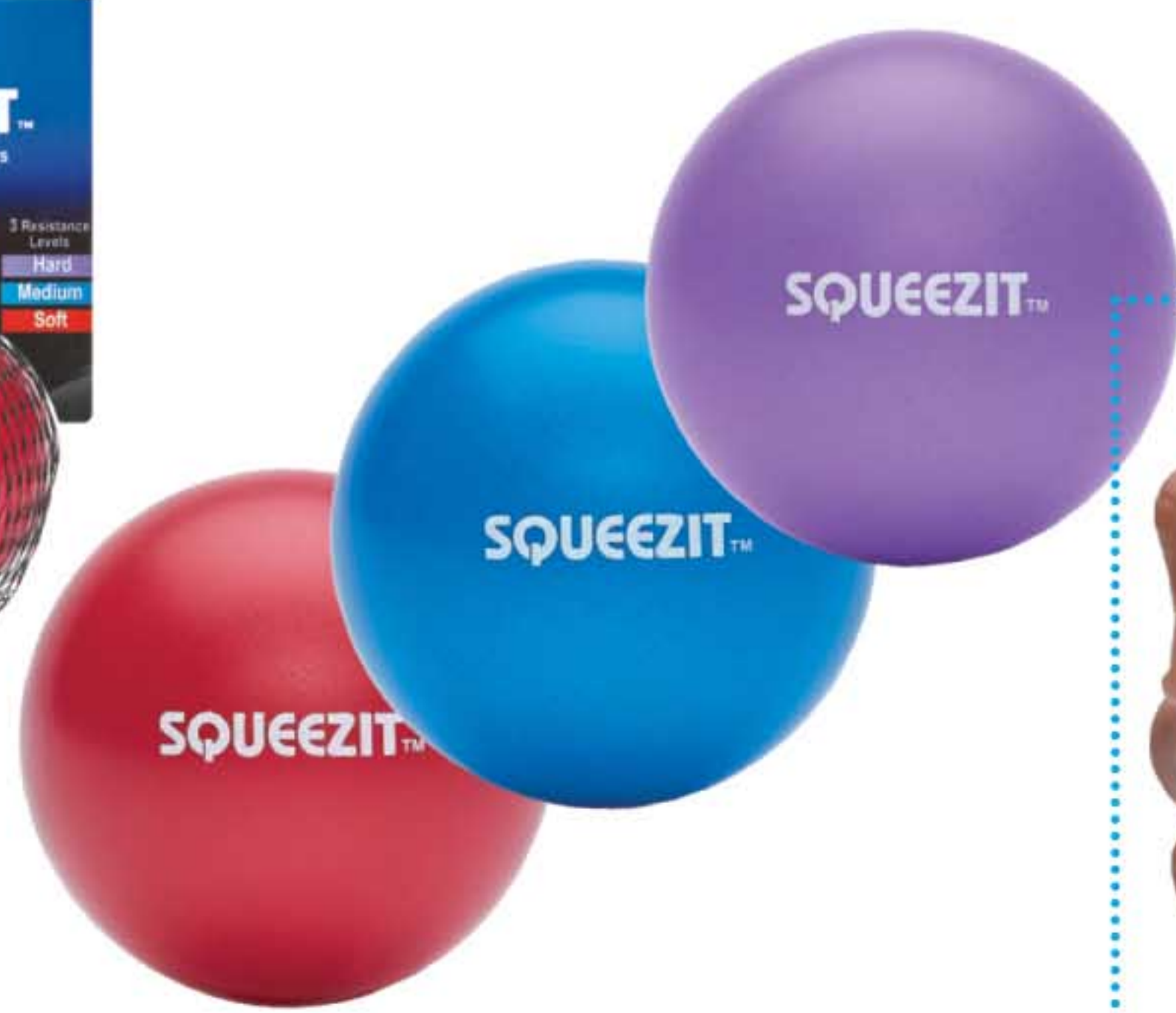

SQUEEZIT™ - 3 resistance levels

Now in 3 Resistance levels

- Red - Soft Squeeze
- Blue - Medium Squeeze
- Purple - Hard Squeeze

Just keep squeezing with increasing pressure to achieve rehabilitation for wrist, hand, tennis elbow, and forearm. We call it "Therapy in every squeeze".

SQ-R - Red; # SQ-B - Blue; SQ-PR - Purple
SQ-3 - SET of three resistance therapy balls

SQ-3 Pack of all 3

DRY FEEL

TOURNA GRIP®



Original Tourna Grip Length!

Ideal length for junior tennis, racquetball, squash, pickleball, badminton and one handers.

Choice of Pete Sampras, Richard Gasquet, James Blake, and many others.

Use for Hot-Humid to Warm Weather

- Ultimate grip for sweaty conditions
- Absorbs like no other grip
- When grip roughs up and frays a bit, it molds to your hand and can provide extra traction.
- Players can use both sides of grip



TG-1-B (3 grips)



TG-10 (10 grips)



TOUR-30 (Pouch of 30 grips)

XL- Ideal length for long handles and two handed backhands

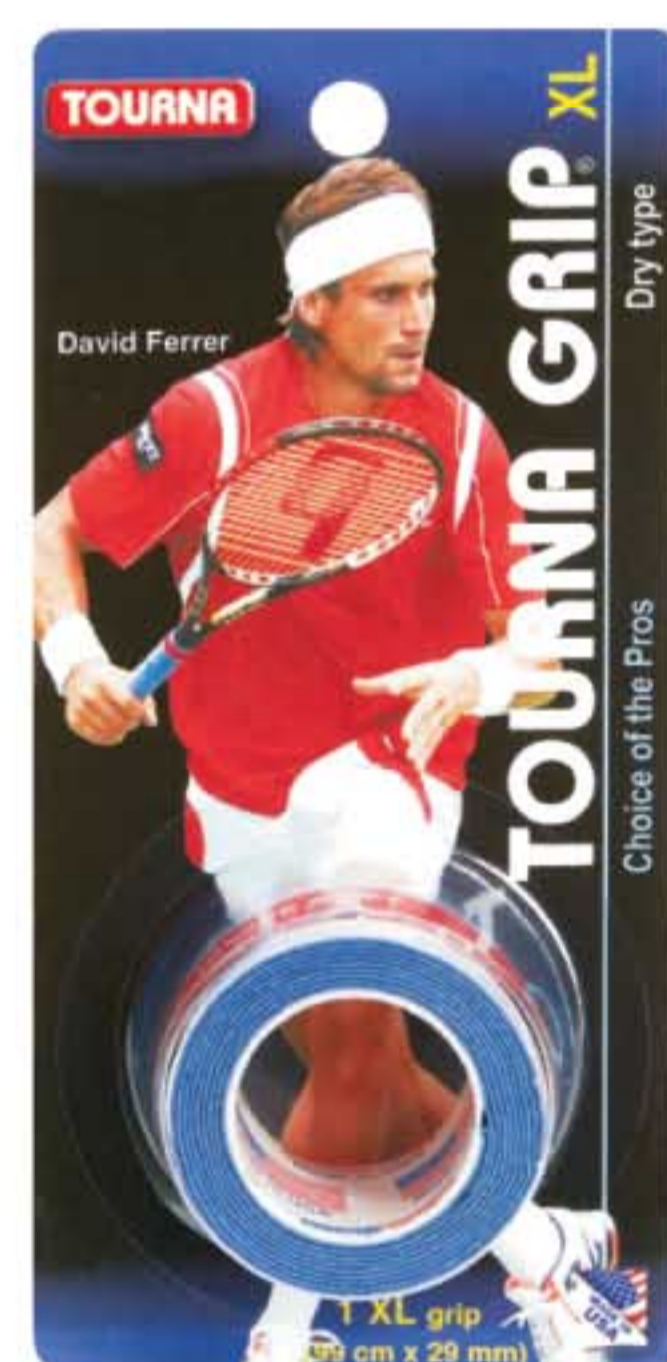

TG-S-B (1 XL grip)

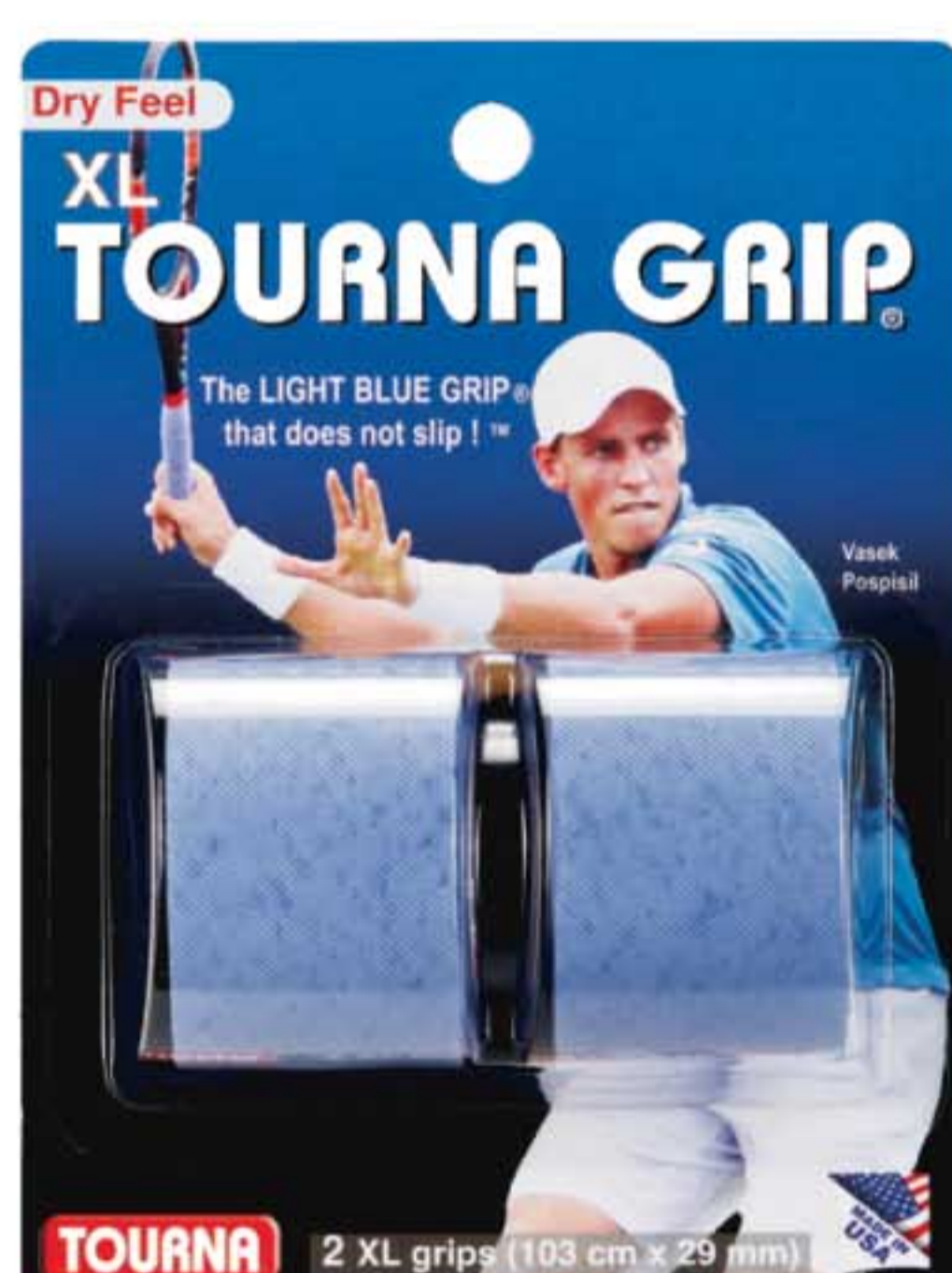

TG-1-2XLB (2 XL grips)



TG-1-XL (3 XL grips)



TG-10-XL (10 XL grips)



TOUR-30XL (30 XL grips)



TG-36 JAR of 36 XL grips

XXL - for extra long grip coverage



TG-1-XXL (3 XXL grips)

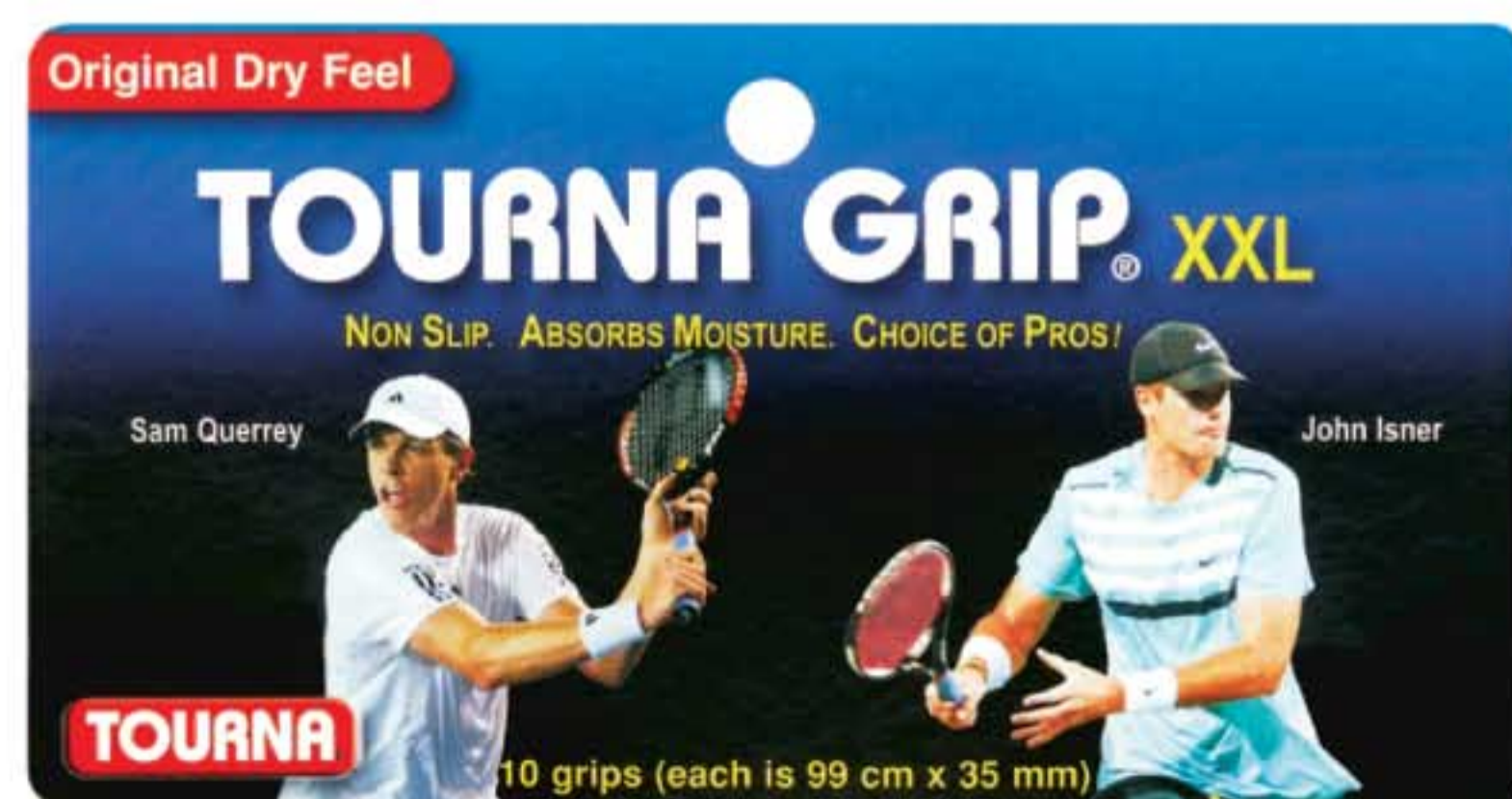

TG-10-XXL (10 XXL grips)



TOUR-30XXL (Pouch of 30 XXL grips)



50 XL Tourna Grips in a Travel Pouch
TOUR-50XL



Sport Accessories



Novel Sport Key Chains

Unique miniature sport replicas with key chain holder. Sport participants and fans love them. Consult price list for stock numbers.
SK-X assorted



SK-XJ Jar display of 48

Wrist Key Holder

Wear it on your wrist, ankle or belt. Made of vinyl. Memory coil stretches and springs back every time. Available in black, clear, white, yellow.

KH -1 Assorted



Oval Athletic Laces

Oval shaped athletic laces in black and white colors. Available in 40", 45" and 54" inch lengths.

- SLO-40-W white;
- SLO-40-BK black
- SLO-45-W white;
- SLO-45-BK black
- SLO-54-W white;
- SLO-54-BK black



Rectangular Shoe Laces

White athletic laces made of cotton. Rectangular flat design that stays tied. Available in 40", 45" and 54" inch long, Rectangular shape available in white:

- # SL-40 (40") white
- # SL-45 (45") white
- # SL-54 (54") white



NECK HUGG

Neck Hugg delivers warmth without the weight. Hugs your neck for total protection from elements. Made of acrylic which wicks perspiration to the front layer and away from neck. Washable.

Available in white and black.

NEK - X



EAR HUGG

Keeps ears, forehead and back of head warm. Great for skiing, jogging, biking and any outdoor activity during cold temperatures. One size fits all. Made of acrylic and stretch nylon. Washable.

Available in black and white.

EH - X



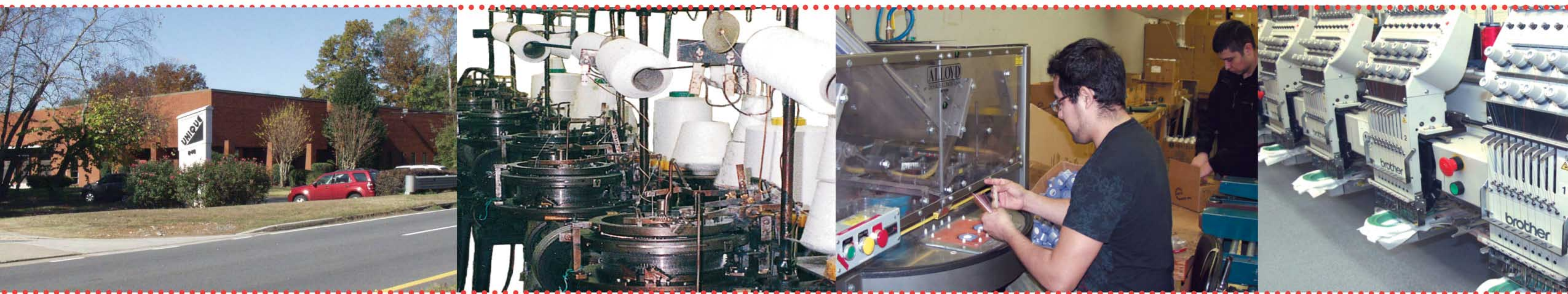

TOURNA

UNIQUE
SPORTS PRODUCTS

**840 McFarland Parkway
Alpharetta, GA. 30004 USA**

770-442-1977

1-800-554-3707

FAX 770-475-2065

E-mail: sales@uniquesports.us

www.uniquesports.com

The following are Registered TRADE MARKS of Unique Sports Products :

Tourna Grip, Light Blue Color Grip, Tourna Tac, Tourna, Mega Tac, Softgrip, Wrist Towel, Super Specs, Great Specs, DOC, Pro View, Ball Doctor, Restore, VibreX, Shock Off, Huggy, Golfers Edge, Pro Stick, Racquet Guard, Stringmeter, Ballport, Pro Tour Grip, Pro Thin Grip, Shock Off, Tourna Gut, Tournafiber, Spiro Elbow Guard, Tennis Elbow Guard-It, Guard Rx, Fill n Drill, Big Hitter, Black 7

The following are TRADE MARKS of Unique Sports Products :

Elbow Guard, Racquet Specs, Clip Wallet, Fingerling, Ball Pocket, Wrist Control, Specs Strap, Pro Specs, Squeezit, Clear View, Hot Mitt, Bear Hug, Ball Claw, Wrist Shield, Tourna Poly, Specs Rx, Score Tube, Xtreme Power, Air Cell, Fingerling, Cube, Liqui Cool, Liqui Towel, Score Tube, Quasi Gut, Grip Bands, Dura Power, Spin Plus, Fill & Drill, Tourna Damp, Grip Rx, Grit

TOURNA TAC®

Warm to Cool Weather

- Tacky with Soft Feel
- Absorbs Moisture

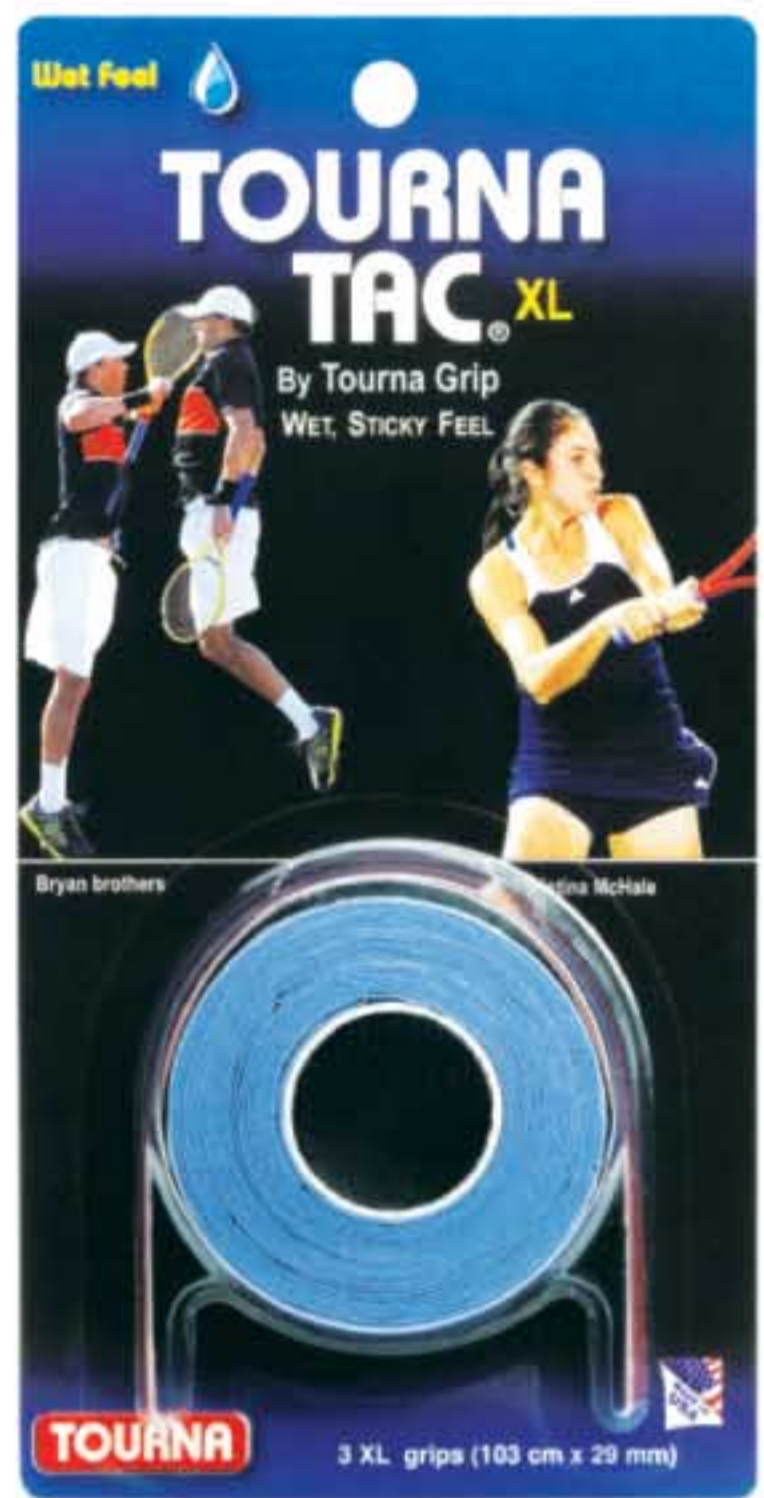

TG-2-XLB 3 pack XL
TG-2-XLB6 3 pack - 6/case



TG-2-10XLB 10 XL pack



TAC-30XLB 30 XL pack, Travel Pouch
TAC-30-XXL-B 30 XXL pack, Travel Pouch



WET FEEL

Superior Tacky Feel! Ideal for cooler weather.

Some players prefer a tacky wet grip. TOURNA TAC® delivers a tacky feel while absorbing sweat to minimize slippage. Grips made in Far East start slipping after only a brief play. Pros switch to a new racquet when grip becomes slippery. A recreational player does not have 4 or more racquets in a bag to switch to when grip starts to slip. Tourna Tac offers the best of both worlds - a tacky feel and a durable, absorbent non-slip grip.



TG-2-XLW - 3 pack XL
TG-2-XLW6 - 3 pack -6/case



TG-2-10XLW 10 pack XL



TG-2-30XLW 30 pack Travel Pouch

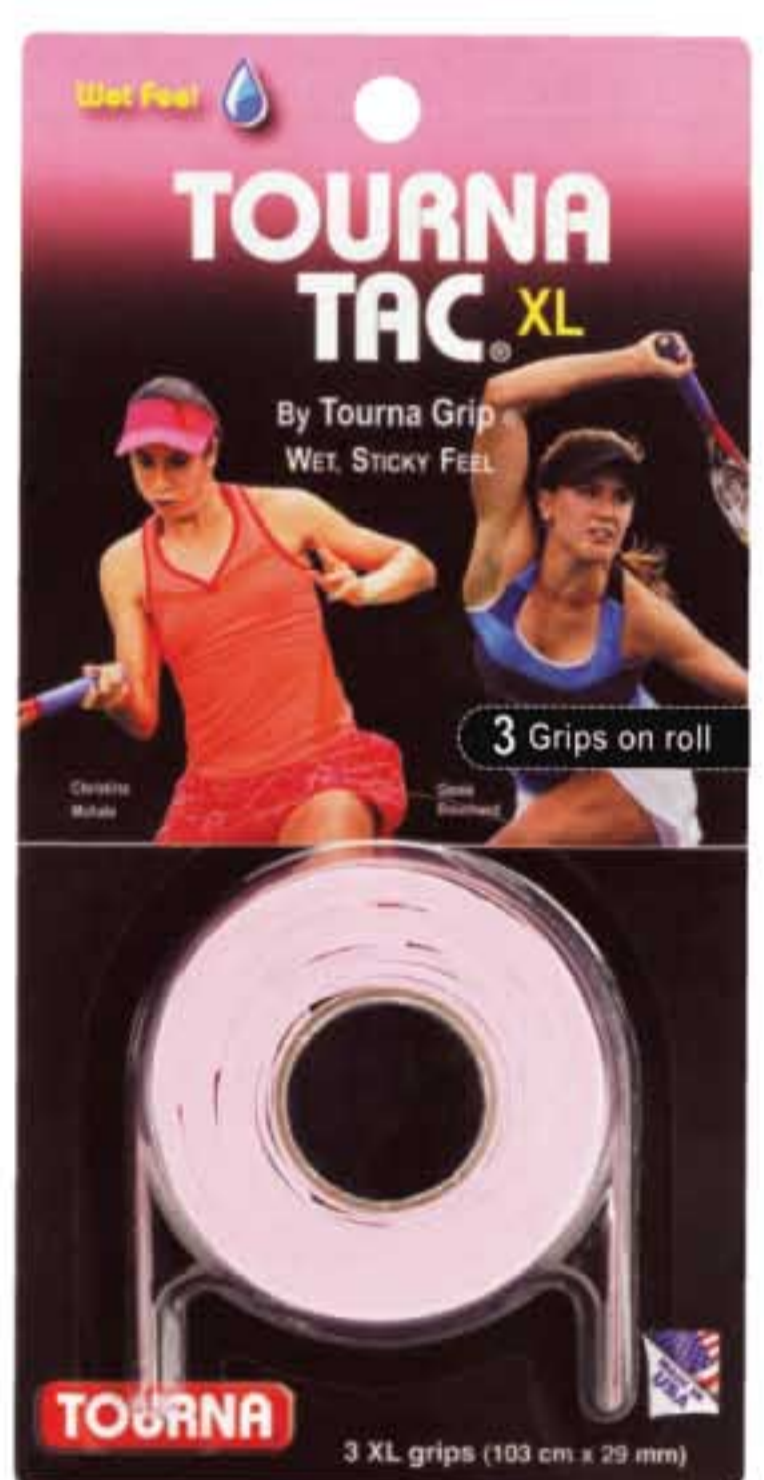

TG-2-XLP 3 XL pack

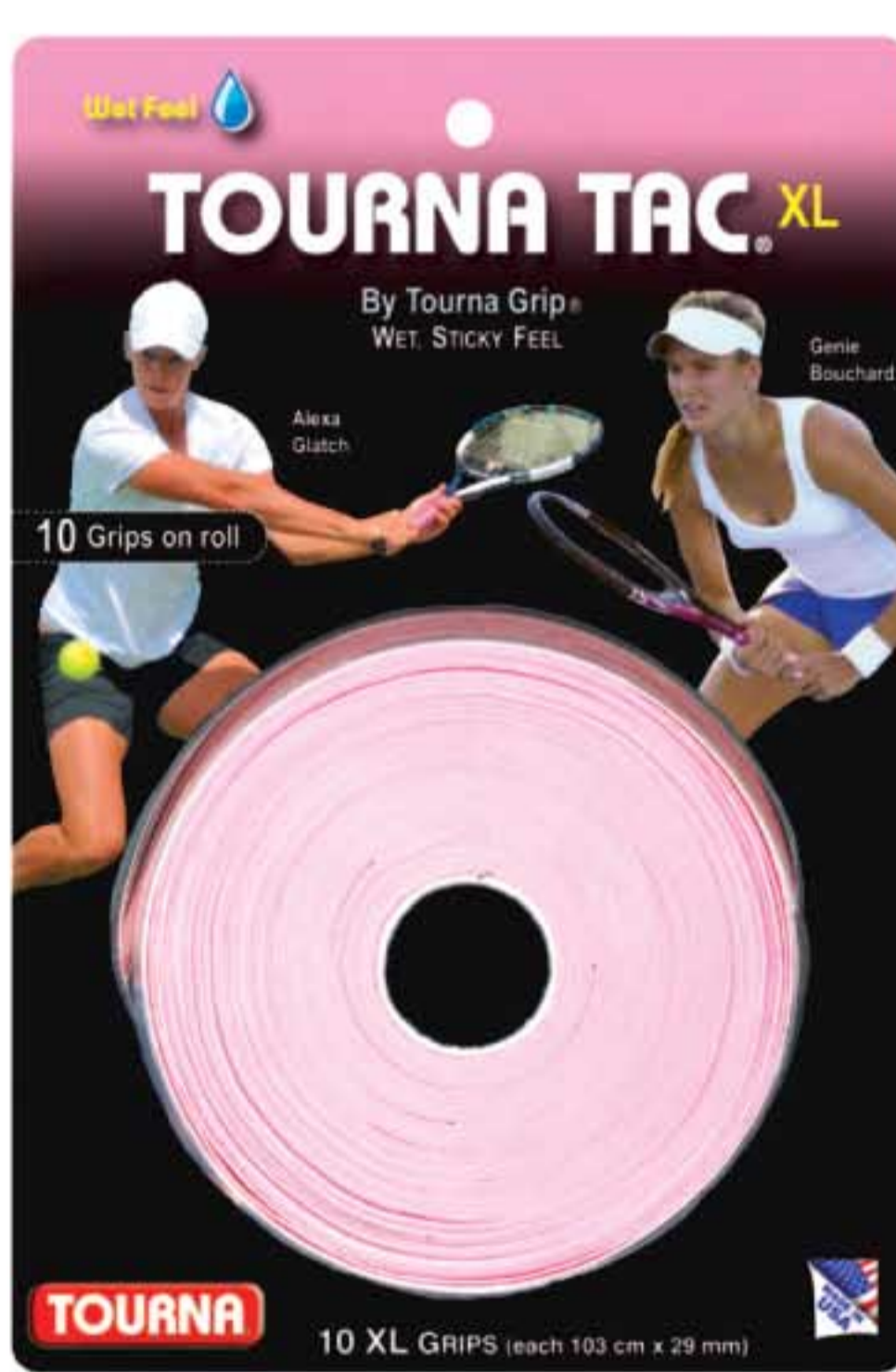

TG-2-10XLP 10 XL pack



TAC-30XLP 30 Travel Pouch pack



TG-2-WPB6, 3 colors on XL roll, (White, Blue, Pink)

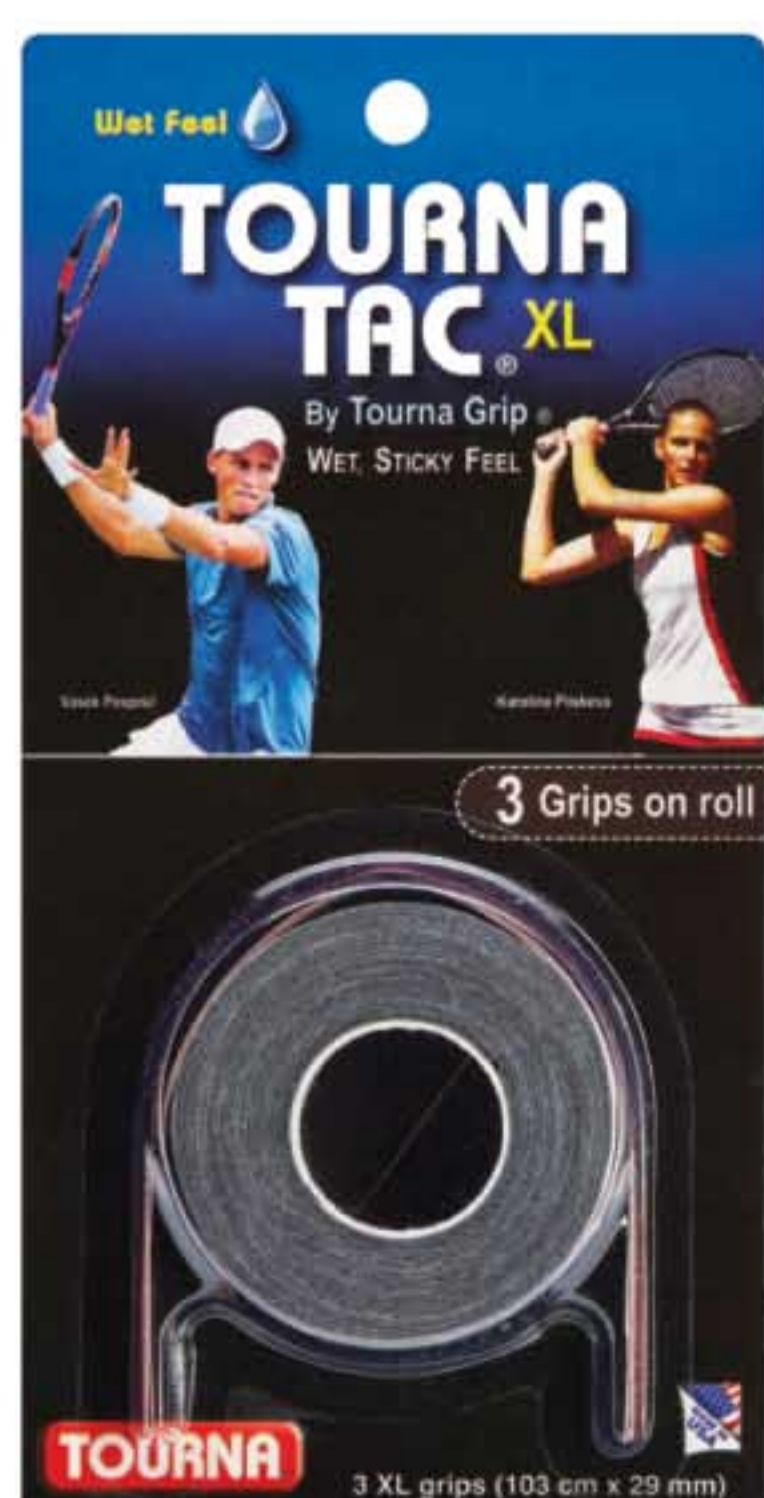

TAC-BK 3 XL pack



TAC-10XL-BK 10 XL pack



TAC-30XL-BK, 30 Travel Pouch pack



TG-2-36J Jar of 36 Tourna Tac XL single rolls 9 of each color



MEGA TAC®



The Tackiest Grip Ever Made ... that stays tacky!

Proprietary tacky PU coating clings to your hand. The back side of Mega Tac is not tacky so it leaves no residue on racquet grip. Mega Tac is very durable and extra wide. It ends twisting and sliding. Other tacky grips lose their tack quickly, but Mega Tac lasts much longer. Mega Tac grips you back and the tack lasts!

Cold-cool-warm weather

- The Tackiest Grip Ever Made!
- The tack that lasts

FEEL THE MAXIMUM GRIPPING!

Available in White, Black, Blue.

Try it and Be Amazed!



3 XL grips per roll
MT-W; MT-B; MT-BK

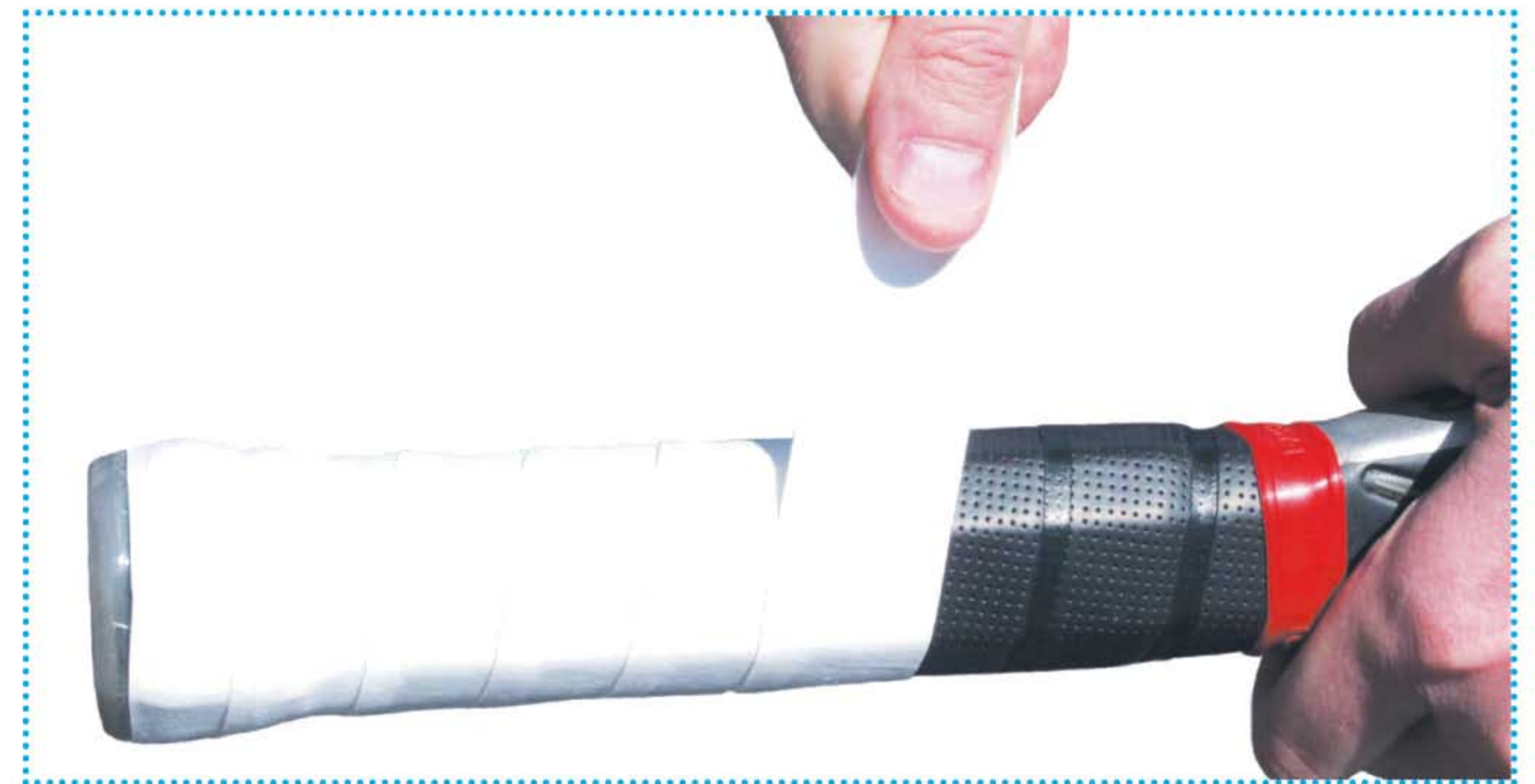

2 XL grips per rolls
MT-2X (Assorted)
White, Blue, Black



10 Grips: MT-10XL-W White,
MT-10XL-B Blue, MT-10XL-BK Black



MT-36J - Display Jar holds 36 XL assorted grips



Travel Pouch with zipper lock - holds 30 grips
MT-30XL-B; MT-30XL-BK; MT-30XL-W

